

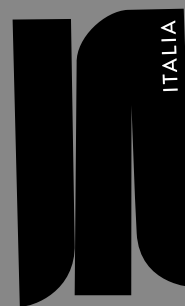

DESIGN  
COLLECTION

LISTINO PREZZI  
PRICE LIST

**A PARTIRE DAL 15 NOVEMBRE  
STARTING FROM 15 NOVEMBER  
2022**



**modesign**

**ESSENZE, MANIGLIE E VETRI**  
**ESSENCES, HANDLES AND GLASSES**

---

**NOCE CANALETTO | AMERICAN WALNUT**



**HAVANA**



**OLIO**



**ORIGINE**



**OLMO**

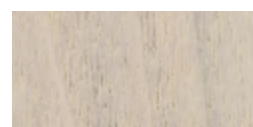

**GESSO**



**PANAMA**

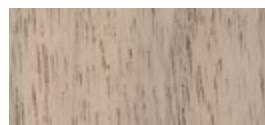

**NATURA**



**CIOCCOLATO**

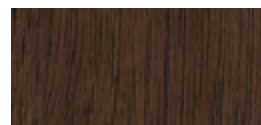

**TORBA**

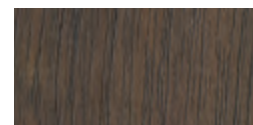

**GRIGIO**



**ANTRACITE**



**BLU**



**ROSSO**



**GIALLO**

---

**VETRI | GLASSES**



**TRASPARENTE**



**FUMÉ**



**TOP SOL**



**CANNETÉ TRASPARENTE**

---

**VETRI DECORATI | DECORATED GLASSES - PER COLLEZIONI | FOR COLLECTIONS: SHANGHAI / SINGAPORE / tavolo - table NORMAN**

VETRO EFFETTO MARMO OPACO | GLASS MATT MARBLE EFFECT

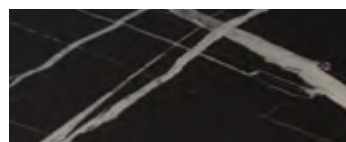

**SAHARA NOIRE**



**KALACATTA**

VETRO EFFETTO METALLO LUCIDO | GLOSSY METALL-EFFECT GLASS



**SILVER**

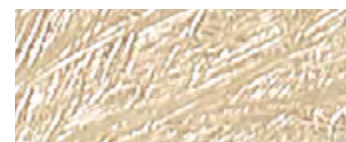

**GOLD**

---

**MARMI | MARBLES - PER COLLEZIONE | FOR COLLECTION: DOMINO**

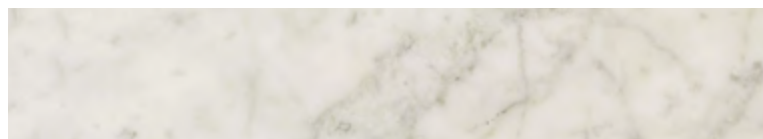

**BIANCO CARRARA**



**EMPERADOR DARK**

---

**MANIGLIE | HANDLES - PER COLLEZIONE | FOR COLLECTION: DOMINO**



**BRONZO**

MANIGLIA GRANDE  
LARGE HANDLE 16.7X2  
MANIGLIA PICCOLA  
SMALL HANDLE 11.7X2



**NICKEL**

MANIGLIA GRANDE  
LARGE HANDLE 16.7X2  
MANIGLIA PICCOLA  
SMALL HANDLE 11.7X2



**CANNA FUCILE**

MANIGLIA GRANDE  
LARGE HANDLE 16.7X2  
MANIGLIA PICCOLA  
SMALL HANDLE 11.7X2

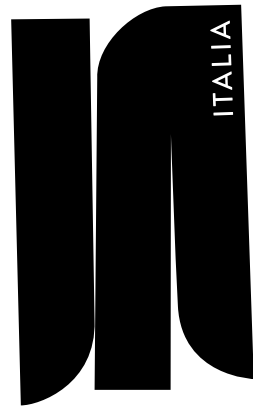

**modesign**



# NOTTE E GIORNO

## NIGHT AND DAY

<b>GUIDA ALLE SPECIFICHE ORDINE</b> GUIDE TO ORDER SPECIFICATIONS	<b>04</b>
<b>CARATTERISTICHE TECNICHE</b> TECHNICAL CHARACTERISTICS	<b>05</b>
<b>LETTI</b> BEDS	<b>26</b>
<b>ARMADI</b> WARDROBES	<b>34</b>
<b>COMODINI, COMÒ , CASSETTIERE</b> BEDSIDE TABLES, CHEST OF DRAWERS, DRAWER UNITS	<b>38</b>
<b>SPECCHIERE</b> MIRRORS	<b>40</b>
<b>VETRINE, CREDENZE, MADIE E PORTA TV</b> DISPLAY UNITS, SIDEBOARDS, CUPBOARDS AND TV UNIT	<b>42</b>
<b>TAVOLI</b> TABLES	<b>44</b>
<b>TAVOLINI E CONSOLLE</b> SMALL TABLES AND CONSOLLE	<b>46</b>
<b>SCRIVANIE, DIVANI E SEDIE</b> DESKS, SOFAS AND CHAIRS	<b>48</b>
<b>COMPOSIZIONI A CATALOGO</b> CATALOGUE COMPOSITIONS	<b>50</b>

# GUIDA ALLE SPECIFICHE ORDINE GUIDE TO ORDER SPECIFICATIONS

AL MOMENTO DELL'ORDINE SPECIFICARE SEMPRE LA FINITURA DELLA STRUTTURA E DEL FRONTALE ED EVENTUALI MULTICOLORE SU TESSUTI DI RIVESTIMENTO

WHEN ORDERING SPECIFY THE CARCASE AND FRONT FINISH AND MULTICOLOUR UPHOLSTERY FABRICS, IF APPLICABLE.

## ESEMPI PER IL CALCOLO PREZZO EXAMPLES FOR PRICE CALCULATION

### MULTICOLORE SU RIVESTIMENTO DOGHE MULTICOLOR ON SLAT COVER

STRUTTURA: FINITURA CANALETTO OLMO  
STRUCTURE: ELM CANALETTO FINISH

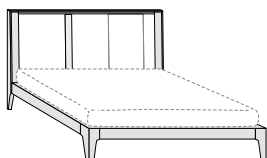

PANNELLO RIVESTITO CON DOGHE MULTICOLORE CAT. B  
PANEL COVERED WITH MULTICOLOR SLATS CAT. B

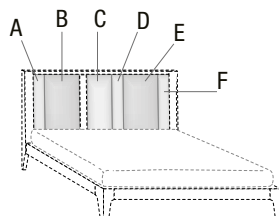

"A-C-E" FINITURA LINO BEIGE  
"B-D-F" FINITURA LINO JEANS  
"A-C-E" BEIGE LINEN FINISH  
"B-D-F" JEANS LINEN FINISH

NEL CASO DI FINITURE DIVERSE ANCHE SE DELLA STESSA CATEGORIA TESSUTO COME NELL'ESEMPIO (A,C,E LINO BEIGE E B,D,F LINO JEANS), IL PREZZO DEVE ESSERE MAGGIORATO AL +10% COME MULTICOLORE TENENDO IN CONSIDERAZIONE CHE, IN PRESENZA DI TESSUTI, SI DEVE FAR RIFERIMENTO ANCHE ALLA CATEGORIA TESSUTO SCELTA.

FOR DIFFERENT FINISHES, EVEN IF THEY ARE IN THE SAME FABRIC CATEGORY, AS IN THE EXAMPLE (A, C, E BEIGE LINEN AND B, D, F LINEN DENIM), ADD 10% TO THE PRICE AS MULTICOLOUR, AND WHEN FABRICS ARE INVOLVED REMEMBER TO INDICATE THE CHOSEN FABRIC CATEGORY.

	CAT. A ECOPELLE/ECONABUK ECOLEATHER/ECONABUK	CAT. B LINO/VELLUTO LINEN/VELVET	CAT. C PELLE LEATHER
CANALETTO	2.573	2.709	3.224
Multicolor	+ 10 %		
	mc 0,25 – Kg 65		

### MULTICOLORE SU FRONTALE MULTICOLOR ON FRONT

STRUTTURA: CANALETTO ANTRACITE  
STRUCTURE: CANALETTO ANTHRACITE

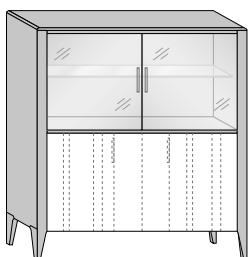

FRONTALI: CANALETTO MULTICOLORE  
FRONTS: CANALETTO MULTICOLOR

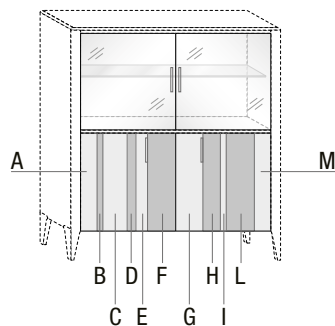

"A-C-E-G-I-M" CANALETTO ANTRACITE  
"B-D-F-H-L" CANALETTO GRIGIO  
"A-C-E-G-I-M" CANALETTO ANTHRACITE  
"B-D-F-H-L" CANALETTO GREY

NEL CASO DI FINITURE DIVERSE TRA FRONTALE E FRONTALE, IL PREZZO DEVE ESSERE MAGGIORATO AL +10% COME MULTICOLORE.

IF FRONT FINISHES ARE DIFFERENT FROM EACH OTHER, ADD 10% TO THE PRICE AS MULTICOLOUR.

CANALETTO	3.528
Multicolor	+ 10 %
	mc 1,13 – Kg 60

### MULTICOLORE SU FRONTALE MULTICOLOR ON FRONT

STRUTTURA: CANALETTO HAVANA  
STRUCTURE: CANALETTO HAVANA

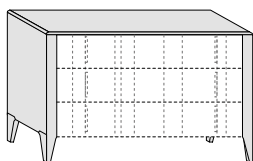

FRONTALI: CANALETTO MULTICOLORE  
DOGA (Z): RIVESTITA CAT.A ECONABUK  
FRONTS: CANALETTO MULTICOLOR  
SLAT (Z): COVERED CAT.A ECONABUK

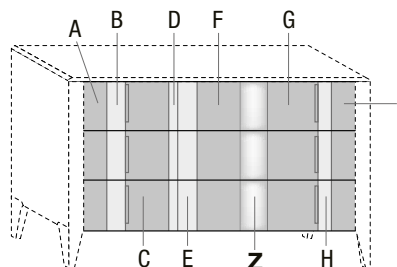

"A-C-F-G-I" CANALETTO OLMO  
"B-D-E-H" CANALETTO BLU  
"A-C-F-G-I" CANALETTO ELM  
"B-D-E-H" CANALETTO BLUE

NEL CASO DI FINITURA FRONTALI DIVERSA DALLA FINITURA STRUTTURA, IL PREZZO DEVE ESSERE MAGGIORATO AL +10% COME MULTICOLORE TENENDO IN CONSIDERAZIONE CHE, IN PRESENZA DI TESSUTI, SI DEVE FAR RIFERIMENTO ANCHE ALLA CATEGORIA TESSUTO SCELTA.

IF FRONT FINISH IS DIFFERENT FROM THE STRUCTURE FINISH, ADD 10% TO THE PRICE AS MULTICOLOUR AND WHEN FABRICS ARE INVOLVED REMEMBER TO INDICATE THE CHOSEN FABRIC CATEGORY.

	CAT. A ECOPELLE/ECONABUK ECOLEATHER/ECONABUK	CAT. B LINO/VELLUTO LINEN/VELVET	CAT. C PELLE LEATHER
CANALETTO	2.231		
Multicolor	+ 10 %		
	mc 0,69 – Kg 70		

CARATTERISTICHE TECNICHE  
TECHNICAL CHARACTERISTICS

LETTI

DIMENSIONI DISPONIBILI ..... CM.160x200 - CM. 180x200

BEDS

AVAILABLE DIMENSIONS ..... CM.160x200 - CM. 180x200

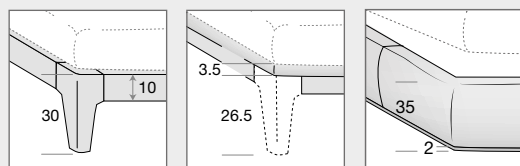

GIROLETTO LEGNO  
WOODEN BED SURROUND

GIROLETTO LEGNO E  
IMBOTTITO  
WOODEN BED SURROUND  
AND UPHOLSTERED  
BLOCKBOARD

GIROLETTO IMBOTTITO  
UPHOLSTERED BED  
SURROUND

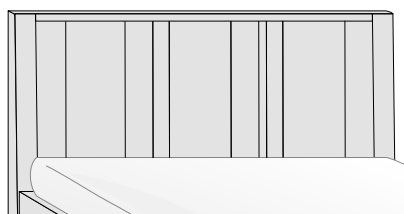

PANNELLO A DOGHE LEGNO  
WOODEN SLATS PANEL

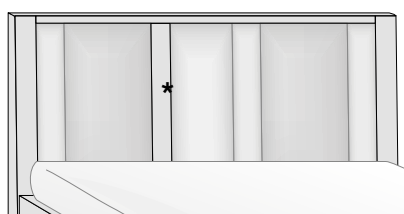

PANNELLO IMBOTTITO A DOGHE NON SFODERABILE  
UPHOLSTERED SLATTED PANEL WITHOUT REMOVABLE COVER



DOGA LEGNO LISCIA  
PLAIN WOODEN SLAT

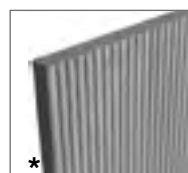

DOGA RIGHE  
STRIPED SLAT

VERSIONE PANNELLO CON DOGHE LEGNO

TESTIERA ..... STRUTTURA IN MASSELLO DI NOCE CANALETTO

PANNELLO ..... MULTISTRATI IMPIALLACCIATO NOCE CANALETTO E DOGHE APPLICATE IN MASSELLO DI NOCE CANALETTO

WOODEN SLATS PANEL VERSION

HEADBOARD ..... STRUCTURE IN SOLID CANALETTO WALNUT

PANEL ..... MULTILAYER PANEL VENEERED IN CANALETTO WALNUT AND SLATS IN SOLID CANALETTO WALNUT

VERSIONE PANNELLO IMBOTTITO A DOGHE

TESTIERA ..... STRUTTURA IN MASSELLO DI NOCE CANALETTO

PANNELLO ..... MULTISTRATI PIOPPA IMBOTTITO IN GOMMAPIUMA E RIVESTITO CON TESSUTI DA CAMPIONARIO

VERSION UPHOLSTERED PANEL WITH SLATS

HEADBOARD ..... STRUCTURE IN SOLID CANALETTO WALNUT

PANEL ..... POPLAR MULTILAYER PANEL UPHOLSTERED WITH FOAM RUBBER AND COVERED WITH SAMPLE FABRICS

DIMENSIONI TESTIERE  
HEADBOARD DIMENSIONS

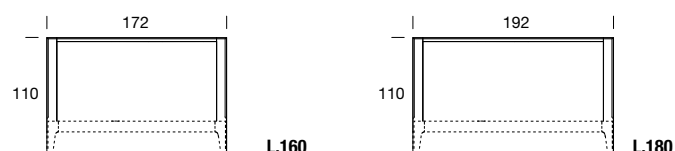

PANNELLO IMBOTTITO

TESTIERA ..... STRUTTURA IN MULTISTRATO DI PIOPPA DA 3 CM.

RIVESTIMENTO ..... TESSUTI E PELLI DA CAMPIONARIO CON LAVORAZIONE A PLISSÉ

UPHOLSTERED PANEL

HEADBOARD ..... STRUCTURE IN 3 CM POPLAR MULTILAYER

UPHOLSTERY ..... FABRICS AND LEATHER FROM SAMPLES

DIMENSIONI TESTIERE  
HEADBOARD DIMENSIONS

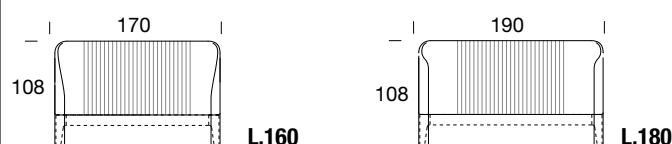

DOMINO

ALBA

### PIEDINI E GIROLETTI FEET AND BED SURROUNDS

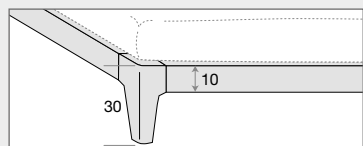

GIROLETTO LEGNO IN PANNELLO LISTELLARE RIVESTITO NOCE CANALETTO – PIEDE IN MASSELLO DI NOCE CANALETTO

WOODEN BED SURROUND IN BLOCKBOARD PANEL COVERED IN CANALETTO WALNUT – FOOT IN SOLID CANALETTO WALNUT

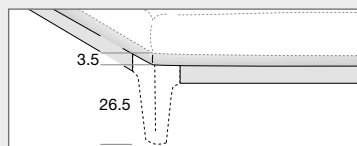

GIROLETTO LEGNO E IMBOTTITO IN PANNELLO DI LISTELLARE NOCE CANALETTO E IMBOTTITO IN GOMMAPIUMA E RIVESTITO CON TESSUTI DA CAMPIONARIO – PIEDE IN MASSELLO DI NOCE CANALETTO

WOODEN BED SURROUND AND UPHOLSTERED IN CANALETTO WALNUT BLOCKBOARD PANEL AND UPHOLSTERED IN FOAM RUBBER AND COVERED WITH SAMPLE FABRICS – FOOT IN SOLID CANALETTO WALNUT

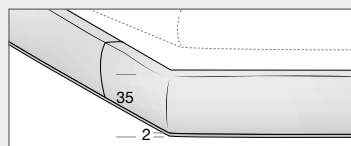

GIROLETTO IMBOTTITO STRUTTURA IN MULTISTRATO DI PIOPPO, IMBOTTITO IN GOMMAPIUMA E RIVESTITO CON TESSUTI DA CAMPIONARIO

UPHOLSTERED BED SURROUND WITH STRUCTURE IN POPLAR MULTILAYER, UPHOLSTERED IN FOAM RUBBER AND COVERED WITH SAMPLE FABRICS

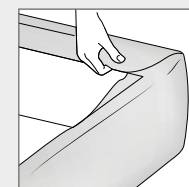

OPTIONAL VERSIONE SFODERABILE  
OPTIONAL VERSION WITHOUT REMOVABLE COVER

PEDRERA

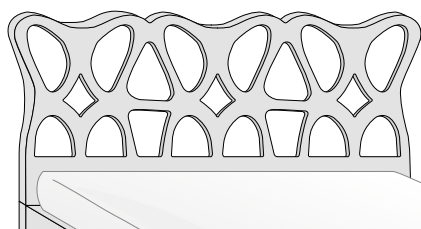

PANNELLO TRAFORATO  
PERFORATED PANEL

### PANNELLO LEGNO

TESTIERA ..... MASSELLO DI NOCE CANALETTO

### WOODEN PANEL

HEADBOARD ..... CANALETTO WALNUT SOLID

### DIMENSIONI TESTIERE HEADBOARD DIMENSIONS

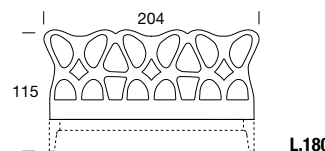
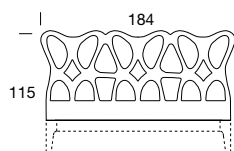

BATTLO

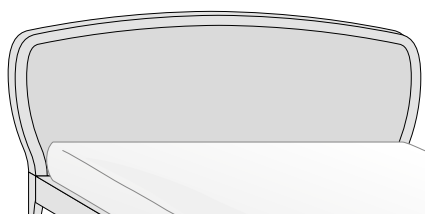

PANNELLO LEGNO  
WOODEN PANEL

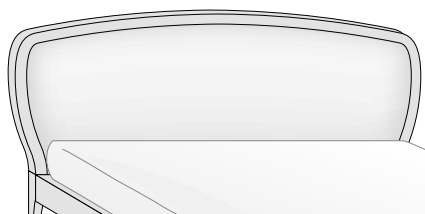

PANNELLO IMBOTTITO, OPTIONAL VERSIONE SFODERABILE  
UPHOLSTERED PANEL, OPTIONAL VERSION WITH REMOVABLE COVER

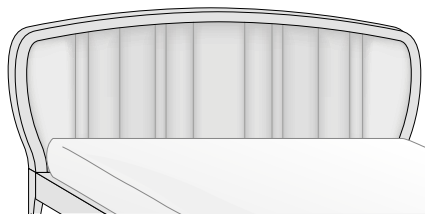

PANNELLO IMBOTTITO A DOGHE, NON SFODERABILE  
NON POSSIBILE MULTICOLORE SU TESSUTO TESTIERA  
SLATTED UPHOLSTERED PANEL, NOT REMOVABLE COVER  
MULTICOLOR ON HEADBOARD FABRIC NOT POSSIBLE

### VERSIONE PANNELLO LEGNO

TESTIERA ..... STRUTTURA IN PANNELLO LISTELLARE RIVESTITO NOCE CANALETTO, BORDATO NOCE CANALETTO E CURVATO

PANNELLO ..... MULTISTRATI IMPIALLACCIATO NOCE CANALETTO

### WOODEN PANEL VERSION

HEADBOARD ..... STRUCTURE IN BLOCKBOARD PANEL COVERED IN CANALETTO WALNUT, WITH EDGE IN CANALETTO WALNUT AND CURVED

PANEL ..... MULTILAYER PANEL VENEERED IN CANALETTO WALNUT

### VERSIONE PANNELLO IMBOTTITO E IMBOTTITO A DOGHE

TESTIERA ..... STRUTTURA IN PANNELLO LISTELLARE RIVESTITO NOCE CANALETTO, BORDATO NOCE CANALETTO E CURVATO

PANNELLO ..... MULTISTRATI PIOPPO IMBOTTITO IN GOMMAPIUMA E RIVESTITO CON TESSUTI DA CAMPIONARIO

### VERSION WITH UPHOLSTERED PANEL AND UPHOLSTERED WITH SLAT

HEADBOARD ..... STRUCTURE IN BLOCKBOARD PANEL COVERED IN CANALETTO WALNUT, WITH EDGE IN CANALETTO WALNUT AND CURVED

PANEL ..... POPLAR MULTILAYER PANEL UPHOLSTERED WITH FOAM RUBBER AND COVERED WITH SAMPLE FABRICS

### DIMENSIONI TESTIERE HEADBOARD DIMENSIONS

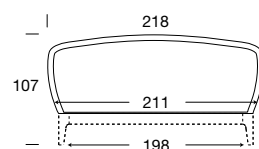
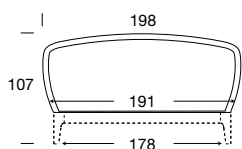

NON POSSIBILE MULTICOLORE SU RIEVISTIMENTO TESTIERA  
NOT POSSIBLE MULTICOLOR ON HEADBOARD COVERING



CARATTERISTICHE TECNICHE  
TECHNICAL CHARACTERISTICS

LETTI

DIMENSIONI DISPONIBILI ..... CM.160x200 - CM. 180x200

BEDS

AVAILABLE DIMENSIONS ..... CM.160x200 - CM. 180x200

SHANGHAI

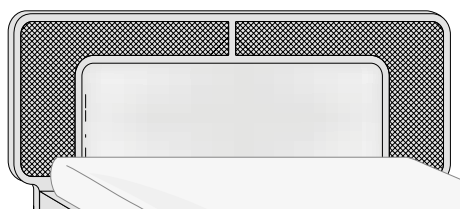

PANNELLO IMBOTTITO CON PARTE IMBOTTITA E PARTE IN PAGLIA DI VIENNA  
UPHOLSTERED PANEL WITH PADDED PART AND PART IN VIENNA STRAW

PANNELLO IMBOTTITO

TESTIERA ..... STRUTTURA IN LISTELLARE IMPIALLACCIATO NOCE CANALETTO, BORDATO NOCE CANALETTO E CURVATO. PANNELLI SUPERIORI IN MIDOLLINO INTRECCIATI "PAGLIA DI VIENNA". PANNELLO INFERIORE IMBOTTITO IN GOMMAPIUMA RIVESTITO CON TESSUTI O PELLI DA CAMPIONARIO

UPHOLSTERED PANEL

HEADBOARD ..... STRUCTURE IN LISTELLAR VENEERED CANALETTO WALNUT, EDGED CANALETTO WALNUT AND CURVED. TOP PANELS IN WICKEN WOVEN "VIENNA STRAW". LOWER PANEL PADDED IN FOAM-FOAM COVERED WITH FABRICS OR LEATHER FROM SAMPLE

DIMENSIONI TESTIERE  
HEADBOARD DIMENSIONS

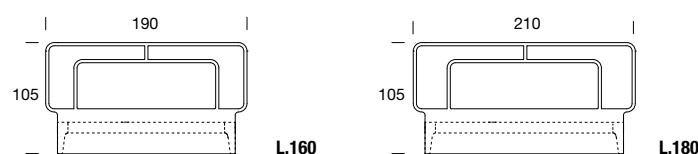

RAINBOW

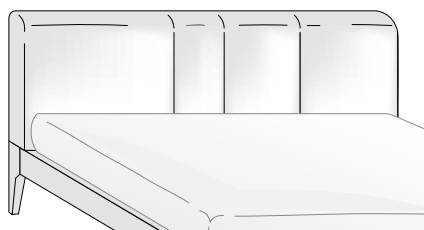

PANNELLO IMBOTTITO CON CUSCINI LISCI, NON SFODERABILE  
UPHOLSTERED PANEL WITH PLAIN CUSHIONS,  
WITHOUT REMOVABLE COVER

VERSIONE PANNELLO IMBOTTITO, NON SFODERABILE

TESTIERA ..... PANNELLO MULTISTRATO PIOPPO IMBOTTITO IN GOMMAPIUMA E RIVESTITO CON TESSUTI DA CAMPIONARIO, PIEDE POSTERIORE COME IL PIEDE ANTERIORE

VERSION WITH UPHOLSTERED PANEL, WITHOUT REMOVABLE COVER

HEADBOARD ..... POPLAR MULTILAYER PANEL UPHOLSTERED WITH FOAM RUBBER AND COVERED WITH SAMPLE FABRICS, REAR FEET THE SAME AS FRONT FEET.

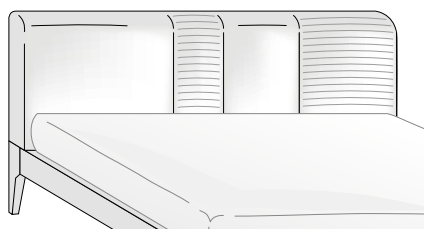

PANNELLO IMBOTTITO CON 2 CUSCINI LISCI E 2 CUSCINI CON CUCITURA BARRÈ, NON SFODERABILE  
UPHOLSTERED PANEL WITH 2 PLAIN CUSHIONS AND 2 CUSHIONS WITH BARRÈ SEAM, WITHOUT REMOVABLE COVER

VERSIONE PANNELLO IMBOTTITO CON CUCITURA BARRÈ, NON SFODERABILE

TESTIERA ..... PANNELLO MULTISTRATO PIOPPO IMBOTTITO IN GOMMAPIUMA, RIVESTITO CON TESSUTI DA CAMPIONARIO E TRAPUNTATO. PIEDE POSTERIORE COME IL PIEDE ANTERIORE

VERSION WITH UPHOLSTERED PANEL WITH BARRÈ SEAM, WITHOUT REMOVABLE COVER

HEADBOARD ..... POPLAR MULTILAYER PANEL UPHOLSTERED WITH FOAM RUBBER AND COVERED WITH SAMPLE FABRICS AND QUILTED. REAR FEET THE SAME AS FRONT FEET.

DIMENSIONI TESTIERE  
HEADBOARD DIMENSIONS

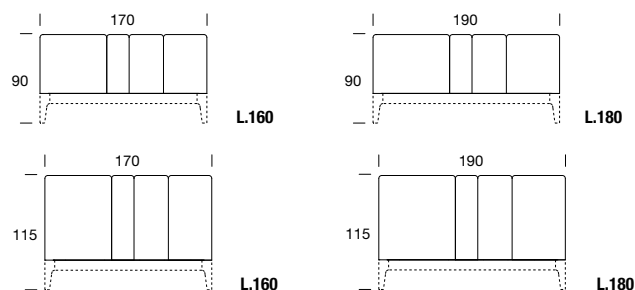

## PIEDINI E GIROLETTI FEET AND BED SURROUNDS

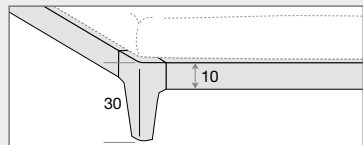

GIROLETTO LEGNO IN PANNELLO LISTELLARE RIVESTITO NOCE CANALETTO – PIEDE IN MASSELLO DI NOCE CANALETTO

WOODEN BED SURROUND IN BLOCKBOARD PANEL COVERED IN CANALETTO WALNUT – FOOT IN SOLID CANALETTO WALNUT

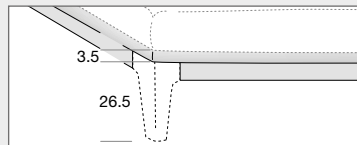

GIROLETTO LEGNO E IMBOTTITO IN PANNELLO DI LISTELLARE NOCE CANALETTO E IMBOTTITO IN GOMMAPIUMA E RIVESTITO CON TESSUTI DA CAMPIONARIO – PIEDE IN MASSELLO DI NOCE CANALETTO

WOODEN BED SURROUND AND UPHOLSTERED IN CANALETTO WALNUT BLOCKBOARD PANEL AND UPHOLSTERED IN FOAM RUBBER AND COVERED WITH SAMPLE FABRICS – FOOT IN SOLID CANALETTO WALNUT

NON DISPONIBILE PER LETTO PEDRERA  
NOT AVAILABLE FOR PEDRERA BED

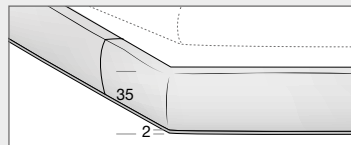

GIROLETTO IMBOTTITO STRUTTURA IN MULTISTRATO DI PIOPPO, IMBOTTITO IN GOMMAPIUMA E RIVESTITO CON TESSUTI DA CAMPIONARIO

UPHOLSTERED BED SURROUND WITH STRUCTURE IN POPLAR MULTILAYER, UPHOLSTERED IN FOAM RUBBER AND COVERED WITH SAMPLE FABRICS

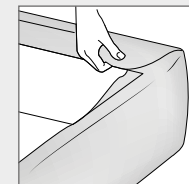

OPTIONAL VERSIONE SFODERABILE  
OPTIONAL VERSION WITHOUT REMOVABLE COVER

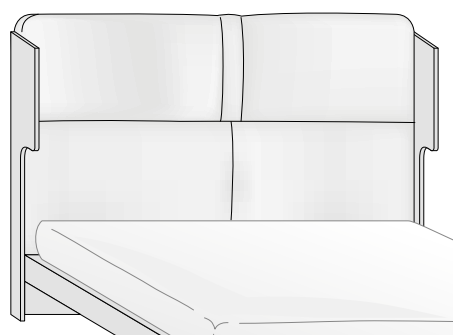

PANNELLO IMBOTTITO NON SFODERABILE  
UPHOLSTERED PANEL WITHOUT REMOVABLE COVER

### PANNELLO IMBOTTITO

**SPALLE TESTIERA** MASSELLO DI NOCE CANALETTO

**PANNELLO** MULTISTRATI DI PIOPPO E PANNELLI IN MULTISTRATI BETULLA IMBOTTITI IN GOMMAPIUMA E RIVESTITI CON TESSUTI DA CAMPIONARIO

### UPHOLSTERED PANEL

**HEADBOARD SIDES** CANALETTO WALNUT SOLID

**PANEL** MULTILAYER OF POPLAR AND BIRCH MULTILAYER PANEL, FOAM RUBBER UPHOLSTERED AND SAMPLES FABRIC COVERED

TOBIA

### DIMENSIONI TESTIERE HEADBOARD DIMENSIONS

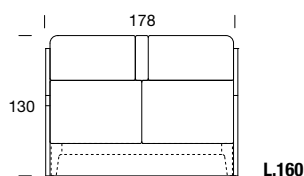

L.160

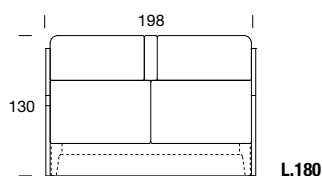

L.180

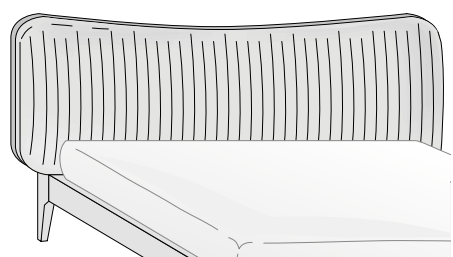

PANNELLO IMBOTTITO NON SFODERABILE  
UPHOLSTERED PANEL WITHOUT REMOVABLE COVER

### PANNELLO IMBOTTITO

**TESTIERA** PANNELLO LISTELLARE SP. 3 CM ANTERIORMENTE RIVESTITO NOCE CANALETTO E BORDATO E POSTERIORMENTE IMPIALLACCIATO FRASSINO O TANGANICA

**PANNELLO** MULTISTRATI PIOPPO 1.5 CM IMBOTTITO IN GOMMAPIUMA CUCITO CON SCANALATURE VERTICALI E RIVESTITO CON TESSUTI DA CAMPIONARIO

### UPHOLSTERED PANEL

**HEADBOARD** BLOCKBOARD PANEL TH. 3 CM. FRONT COVERED IN CANALETTO WALNUT AND EDGED, BACK VENEERED IN ASHWOOD OR TANGANICA

**PANEL** POPLAR MULTILAYER 1.5 CM UPHOLSTERED WITH FOAM RUBBER WITH VERTICAL GROOVE AND COVERED WITH SAMPLE FABRICS

BUTTERFLY

### DIMENSIONI TESTIERE HEADBOARD DIMENSIONS

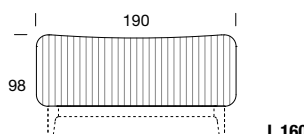

L.160

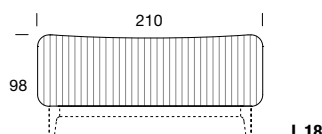

L.180

NON POSSIBILE MULTICOLORE SU RIVESTIMENTO TESTIERA  
NOT POSSIBLE MULTICOLOR ON HEADBOARD COVERING

CARATTERISTICHE TECNICHE  
TECHNICAL CHARACTERISTICS

COMODINO, COMÒ E CASSETTIERA  
BEDSIDE TABLE, CHEST OF DRAWERS AND DRAWER UNIT

COMODINO 2 CASSETTI  
BEDSIDE TABLE WITH 2 DRAWERS

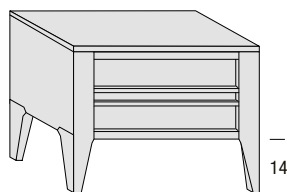

COMÒ 3 CASSETTI  
CHEST OF DRAWERS WITH 3 DRAWERS

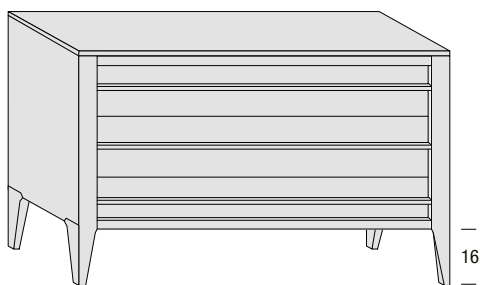

CASSETTIERA 5 CASSETTI  
5-DRAWER UNIT

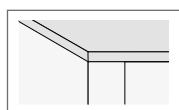
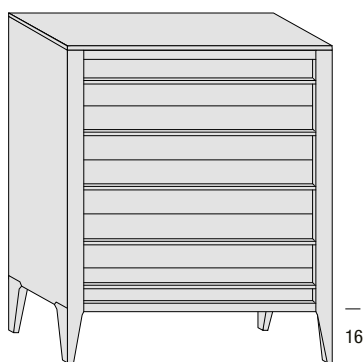

DETTAGLIO TOP DRITTO  
STRAIGHT TOP DETAIL

COMODINO, COMÒ E CASSETTIERA

**STRUTTURA:** PANNELLO DI LISTELLARE ESTERNO RIVESTITO IN NOCE CANALETTO E INTERNO RIVESTITO IN NOCE TANGANICA

**TOP:** PANNELLO DI MDF IMPIALLACCIATO E BORDATO IN NOCE CANALETTO

**FRONTALE CASSETTO LEGNO:** PANNELLO DI LISTELLARE RIVESTITO IN NOCE CANALETTO E IN NOCE TANGANICA SP. 2.9 CM - CON LISTELLI ORIZZONTALI IN MASSELLO DI NOCE CANALETTO

**CASSETTO:** STRUTTURA IN PANNELLO DI MULTISTRATI BETULLA SPESSORE 1.5 CM , FONDO CASSETTO MULTISTRATI IMPIALLACCIATO FRASSINO SPESSORE 0.8 CM

**SPALLE:** LEGNO FJ RIVESTITO NOCE CANALETTO SEZIONE 60/70X25

**PIEDI POSTERIORI:** MASSELLO DI NOCE CANALETTO

**SCHIENALI:** MULTISTRATO PIOPPO SPESSORE 0.8 CM.

**GUIDE:** AMMORTIZZATE REGOLABILI IN ALTEZZA

**APERTURA** MANIGLIA INTEGRATA IN LEGNO

**OPTIONAL FRONTALI:** VETRO DI VARIE DECORAZIONI (SILVER/GOLD/SAHARA NOIRE, KALACATTA) SP. 3MM

**OPTIONAL PIANI:** VETRO EFFETTO MARMO (SAHARA NOIRE, KALACATTA) SP. 3MM

BEDSIDE TABLE, CHEST OF DRAWERS AND DRAWERS UNIT

**STRUCTURE:** BLOCKBOARD PANEL: OUTSIDE COVERED IN CANALETTO WALNUT, INSIDE COVERED IN TANGANICA WALNUT

**TOP:** VENEERED MDF PANEL EDGED IN CANALETTO WALNUT

**WOODEN DRAWER FRONT:** MULTILAYER PANEL COVERED IN CANALETTO WALNUT AND TANGANICA WALNUT SP. 2.9 CM - WITH HORIZONTAL STRIPS IN SOLID CANALETTO WALNUT

**DRAWER:** STRUCTURE IN MULTILAYER BIRCH PANEL TH. 1.5 CM, DRAWER BOTTOM IN MULTILAYER ASHWOOD VENEERED TH. 0.8 CM

**SUPPORT PANELS:** FJ WOOD COVERED IN CANALETTO WALNUT 60/70X25 SECTION

**BACK FEET:** SOLID CANALETTO WALNUT

**BACK PANELS:** POPLAR MULTILAYER TH. 0.8 CM.

**GUIDES:** HEIGHT ADJUSTABLE SOFT-CLOSE GUIDES

**OPENING** INTEGRATED WOODEN HANDLE

**FRONTAL OPTIONALS:** GLASS OF VARIOUS DECORATIONS (SILVER / GOLD / SAHARA NOIRE, KALACATTA) SP. 3MM

**OPTIONAL TOP:** GLASS MARBLE EFFECT (SAHARA NOIRE, KALACATTA) TH. 3MM

SHANGHAI

### COMODINO, COMÒ E CASSETTIERA

#### BEDSIDE TABLE, CHEST OF DRAWERS AND DRAWER UNIT

##### COMODINO 2 CASSETTI BEDSIDE TABLE WITH 2 DRAWERS

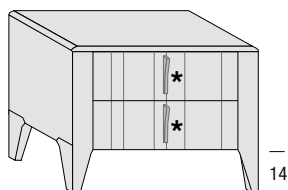

##### COMÒ 3 CASSETTI CHEST OF DRAWERS WITH 3 DRAWERS

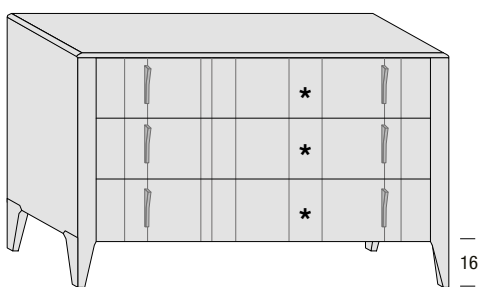

##### CASSETTIERA 5 CASSETTI 5-DRAWER UNIT

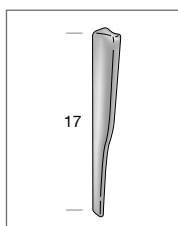
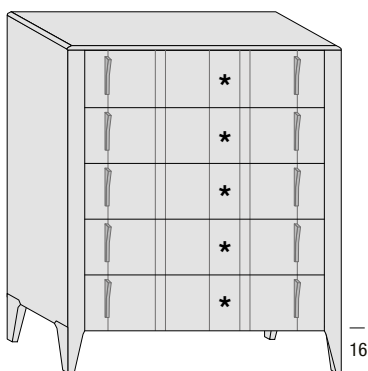

MANIGLIA GRANDE  
LARGE HANDLE

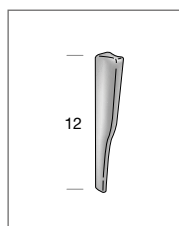

MANIGLIA PICCOLA  
SMALL HANDLE

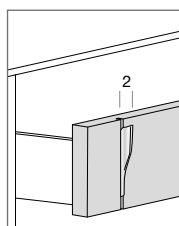

INCASTRO MANIGLIA  
HANDLE JOINT

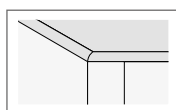

DETTAGLIO TOP SAGOMATO  
SHAPE TOP DETAIL



\* DOGA LEGNO LISCIA  
PLAIN WOODEN SLAT



\* DOGA RIGHE  
STRIPED SLAT



\* DOGA QUADRO LEGNO  
WOODEN SQUARE SLAT

##### COMODINO, COMÒ E CASSETTIERA

<b>STRUTTURA:</b>	PANNELLO DI LISTELLARE ESTERNO RIVESTITO IN NOCE CANALETTO E INTERNO RIVESTITO IN NOCE TANGANICA
<b>TOP:</b>	PANNELLO DI LISTELLARE RIVESTITO NOCE CANALETTO E STRUTTURA PERIMETRALE IN MASSELLO DI NOCE CANALETTO, SP 1.8
<b>FRONTALE CASSETTO LEGNO:</b>	PANNELLO DI LISTELLARE RIVESTITO INTERNAMENTE IN NOCE CANALETTO ED ESTERNAMENTE IN NOCE TANGANICA SP. 2.9 CM – CON DOGE IN MULTISTRATI RIVESTITE NOCE CANALETTO E LATI IN MASSELLO DI NOCE CANALETTO SP. 0.3 CM
<b>CASSETTO:</b>	STRUTTURA IN PANNELLO DI MULTISTRATI BETULLA SPESSORE 1.5 CM , FONDO CASSETTO MULTISTRATI IMPIALLACCIATO FRASSINO SPESSORE 0.8 CM
<b>SPALLE:</b>	LEGNO FJ RIVESTITO NOCE CANALETTO SEZIONE 60/70X25
<b>PIEDI POSTERIORI:</b>	MASSELLO DI NOCE CANALETTO
<b>SCHIENALI:</b>	MULTISTRATO PIOPPO SPESSORE 0.8 CM.
<b>GUIDE:</b>	AMMORTIZZATE REGOLABILI IN ALTEZZA
<b>APERTURA</b>	MANIGLIA DOMINO SU DISEGNO
<b>OPTIONAL:</b>	PIANO IN MARMO

##### BEDSIDE TABLE, CHEST OF DRAWERS AND DRAWERS UNIT

<b>STRUCTURE:</b>	BLOCKBOARD PANEL: OUTSIDE COVERED IN CANALETTO WALNUT, INSIDE COVERED IN TANGANICA WALNUT
<b>TOP:</b>	BLOCKBOARD PANEL COVERED IN CANALETTO WALNUT AND PERIMETRIC STRUCTURE IN SOLID CANALETTO WALNUT, TH 1.8
<b>WOODEN DRAWER FRONT:</b>	BLOCKBOARD PANEL COVERED INSIDE IN CANALETTO WALNUT, OUTSIDE IN TANGANICA WALNUT TH. 2.9 CM – WITH MULTILAYER SLATS COVERED IN CANALETTO WALNUT AND SIDES IN SOLID CANALETTO WALNUT TH. 0.3 CM
<b>DRAWER:</b>	STRUCTURE IN MULTILAYER BIRCH PANEL TH. 1.5 CM, DRAWER BOTTOM IN MULTILAYER ASHWOOD VENEERED TH. 0.8 CM
<b>SUPPORT PANELS:</b>	FJ WOOD COVERED IN CANALETTO WALNUT 60/70X25 SECTION
<b>BACK FEET:</b>	SOLID CANALETTO WALNUT
<b>BACK PANELS:</b>	POPLAR MULTILAYER TH. 0.8 CM.
<b>GUIDES:</b>	HEIGHT ADJUSTABLE SOFT-CLOSE GUIDES
<b>OPENING:</b>	DOMINO HANDLE AS IN THE DRAWING
<b>OPTIONAL:</b>	MARBLE TOP

CARATTERISTICHE TECNICHE  
TECHNICAL CHARACTERISTICS

COMODINO E COMÒ  
BEDSIDE TABLE AND CHEST OF DRAWERS

COMODINO 2 CASSETTI  
BEDSIDE TABLE WITH 2 DRAWERS

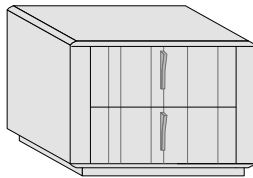

COMÒ 3 CASSETTI  
CHEST OF DRAWERS WITH 3 DRAWERS

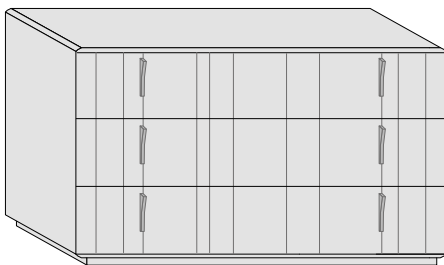

COMODINO, COMÒ

- STRUTTURA:** PANNELLO DI LISTELLARE ESTERNO RIVESTITO IN NOCE CANALETTO E INTERNO RIVESTITO IN NOCE TANGANICA
- TOP:** PANNELLO DI LISTELLARE RIVESTITO NOCE CANALETTO E STRUTTURA PERIMETRALE IN MASSELLO DI NOCE CANALETTO, SP. 1.8
- FRONTALE CASSETTO LEGNO:** PANNELLO DI LISTELLARE RIVESTITO INTERNAMENTE IN NOCE CANALETTO ED ESTERNAMENTE IN NOCE TANGANICA SP. 2.9 CM – CON DOGE IN MULTISTRATI RIVESTITE NOCE CANALETTO E LATI IN MASSELLO DI NOCE CANALETTO SP. 0.3 CM
- CASSETTO:** STRUTTURA IN PANNELLO DI MULTISTRATI BETULLA SPESSORE 1.5 CM , FONDO CASSETTO MULTISTRATI IMPIALLACCIATO FRASSINO SPESSORE 0.8 CM
- SPALLE:** LEGNO FJ RIVESTITO NOCE CANALETTO SEZIONE 60/70X25
- SCHIENALI:** MULTISTRATO PIOPPO SPESSORE 0.8 CM.
- ZOCCOLO:** PANNELLO DI MULTISTRATI PIOPPO SPESSORE 1.8 CM E STRUTTURA PERIMETRALE IN MASSELLO DI NOCE CANALETTO
- GUIDE:** AMMORTIZZATE REGOLABILI IN ALTEZZA
- APERTURA:** MANIGLIA DOMINO SU DISEGNO
- OPTIONAL:** PIANO IN MARMO

BEDSIDE TABLE, CHEST OF DRAWERS

- STRUCTURE:** BLOCKBOARD PANEL: OUTSIDE COVERED IN CANALETTO WALNUT, INSIDE COVERED IN TANGANICA WALNUT
- TOP:** BLOCKBOARD PANEL COVERED IN CANALETTO WALNUT AND PERIMETRIC STRUCTURE IN SOLID CANALETTO WALNUT, SP. 1.8
- WOODEN DRAWER FRONT:** BLOCKBOARD PANEL COVERED INSIDE IN CANALETTO WALNUT AND OUTSIDE IN TANGANICA WALNUT TH. 2.9 CM – WITH MULTILAYER SLATS COVERED IN CANALETTO WALNUT AND SIDES IN SOLID CANALETTO WALNUT TH. 0.3 CM
- DRAWER:** STRUCTURE IN BIRCH MULTILAYER PANEL TH. 1.5 CM , ASHWOOD VENEERED MULTILAYER DRAWER BOTTOM TH 0.8 CM
- SUPPORT PANELS:** FJ WOOD COVERED IN CANALETTO WALNUT 60/70X25 SECTION
- BACK PANELS:** POPLAR MULTILAYER TH. 0.8 CM.
- PLINTH:** POPLAR MULTILAYER PANEL TH. 1.8 CM AND PERIMETRIC STRUCTURE IN SOLID CANALETTO WALNUT
- GUIDES:** HEIGHT ADJUSTABLE SOFT-CLOSE GUIDES
- OPENING:** DOMINO HANDLE AS IN THE DRAWING
- OPTIONAL:** MARBLE TOP

MEMPHIS

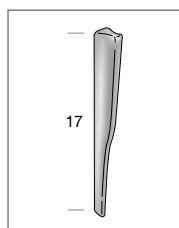

MANIGLIA GRANDE  
LARGE HANDLE

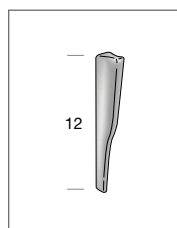

MANIGLIA PICCOLA  
SMALL HANDLE

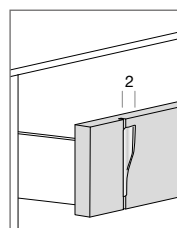

INCASTRO MANIGLIA  
HANDLE JOINT

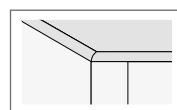

DETTAGLIO TOP SAGOMATO  
SHAPED TOP DETAIL



\* DOGA LEGNO LISCIA  
PLAIN WOODEN SLAT



\* DOGA RIGHE  
STRIPED SLAT



\* DOGA QUADRO LEGNO  
WOODEN SQUARE SLAT

### ARMADI ANTE SCORREVOLI E BATTENTI SLIDING DOOR AND HINGED DOOR WARDROBES

#### SCocca DI SERIE

<b>CAPPELLO, FONDO E FIANCO DIVISORIO</b>	PANNELLO DI PARTICELLE DI LEGNO IMPIALLACCIATO 2 LATI IN DECORATIVO "OLMO SBIANCATO" SP. 2,5 CM
<b>FIANCO ESTERNO</b>	PANNELLO IN LEGNO CON TELAIO IN ABETE DI SP. CM. 3 IMPIALLACCIATO ESTERNAMENTE IN NOCE TANGANICA VERNICIATO ED INTERNAMENTE IN DECORATIVO "OLMO SBIANCATO"
<b>RIPIANO</b>	PANNELLO DI PARTICELLE DI LEGNO IMPIALLACCIATO 2 LATI IN DECORATIVO "OLMO SBIANCATO" SP. 2,5 CM E BORDO FRONTALE SP. 3,6 CM
<b>SCHIENALE</b>	PANNELLO DI MDF IMPIALLACCIATO IN DECORATIVO "OLMO SBIANCATO" SP. CM.0,6
<b>CASSETTIERA</b>	FONDO E FIANCHI IN PANNELLO DECORATIVO, FRONTALE E STRUTTURA CASSETTI IN PARTICELLE DI LEGNO, FRONTALE CASSETTO IN PANNELLO DECORATIVO. I CASSETTI SCORRONO SU GUIDE A SCOMPARSA AD ESTRAZIONE PARZIALE. RIPIANO COPRI CASSETTIERA IN PANNELLO DI PARTICELLE DI LEGNO IMPIALLACCIATO IN DECORATIVO SP. CM.4

#### STANDARD STRUCTURE

<b>TOP AND BOTTOM PANEL</b>	PANEL OF WOOD PARTICLES VENEERED 2 SIDES IN DECORATIVE "OLMO SBIANCATO" TH. 2.5 CM
<b>OUTSIDE SIDE PANEL</b>	WOODEN PANEL WITH FIR FRAME TH. CM. 3, OUTSIDE VENEERED IN PAINTED TANGANICA WALNUT AND INSIDE IN DECORATIVE.
<b>SHELF</b>	PANEL OF WOOD PARTICLES COVERED ON 2 SIDES IN DECORATIVE "OLMO SBIANCATO" TH. 2.5 CM AND FRONT EDGE TH. 3.6 CM
<b>BACK PANEL</b>	VENEERED MDF PANEL IN "OLMO SBIANCATO" DECORATIVE THICKNESS. CM.0,6
<b>DRAWER UNIT</b>	BOTTOM AND SIDE IN DECORATIVE PANEL TH. CM. 1.8, DRAWER STRUCTURE AND FRONT WOOD PARTICLE, DRAWER FRONT IN DECORATIVE PANEL TH. CM. 1.8. DRAWERS RUN ON PARTIAL EXTRACTION CONCEALED GUIDES. DRAWER UNIT SHELF IN WOOD PARTICLE BOARD PANEL VENEERED IN DECORATIVE TH. CM.1,9. FRONT EDGE TH. CM 3,6 .

#### HOLA | BATTENTE - HINGED DOORS

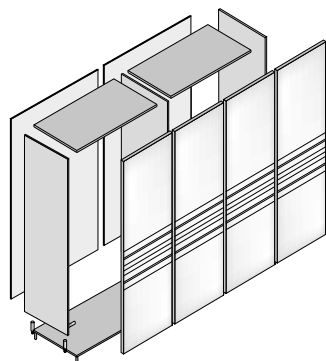

**VERSIONE 4 ANTE BATTENTE**  
VERSION WITH 4 HINGED DOOR

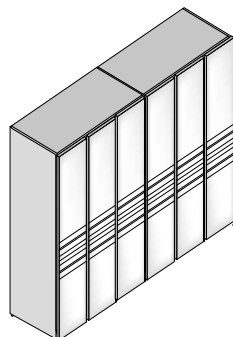

**VERSIONE 6 ANTE BATTENTE**  
VERSION WITH 6 HINGED DOOR

#### ARMADIO HOLA 4 e 6 ANTE BATTENTI

<b>ANTE</b>	PANNELLO IN LEGNO CON TELAIO IN ABETE E COPERTINE IN MDF IMPIALLACCIATO NOCE CANALETTO.
<b>DECORO ORIZZONTALE</b>	LISTELLI DI MASSELLO DI NOCE CANALETTO VERNICIATO.
<b>APERTURA</b>	MANIGLIA IN MASSELLO DI NOCE CANALETTO.
<b>OPTIONALS</b>	FASCIA DECORATA: VETRO DI VARIE DECORAZIONI (SILVER, GOLD, SAHARA NOIRE, KALACATTA O SPECCHIO FUME') SP. 3MM

#### HOLA 4 AND 6 HINGED DOORS WARDROBE

<b>DOORS</b>	WOODEN PANEL WITH FIR FRAME AND COVERS IN CANALETTO WALNUT VENEERED MDF.
<b>HORIZONTAL DECORATION</b>	SOLID STRIPS IN CANALETTO WALNUT
<b>OPENING</b>	HANDLE IN SOLID CANALETTO WALNUT
<b>OPTIONALS</b>	DECORATED BAND: GLASS OF VARIOUS DECORATIONS (SILVER, GOLD, SAHARA NOIRE, KALACATTA OR SMOKED MIRROR ') SP. 3MM

#### HOLA | SCORREVOLE - SLIDING DOORS

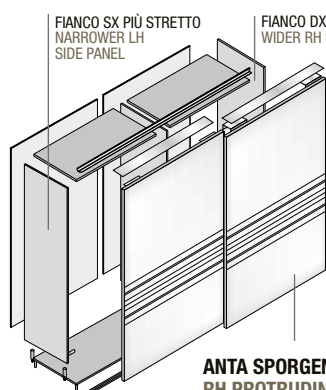

**VERSIONE 2 ANTE LEGNO**  
VERSION WITH 2 WOODEN DOOR

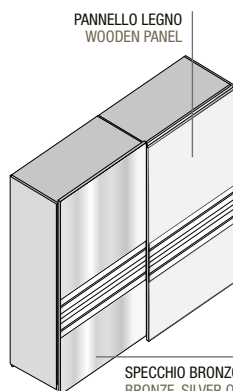

**VERSIONE 1 ANTA SPECCHIO, 1 ANTA LEGNO**  
VERSION WITH 1 WOODEN AND 1 MIRROR DOOR

#### ARMADIO HOLA 2 ANTE SCORREVOLI CON O SENZA SPECCHI

<b>ANTE</b>	PANNELLO FRONTALE DI MULTISTRATI IMPIALLACCIATO NOCE CANALETTO SP. 0,8 CM E STRUTTURA IN LISTELLARE DI NOCE TANGANICA DA CM 1,8 VERNICIATO.
<b>DECORO ORIZZONTALE</b>	LISTELLI DI MASSELLO DI NOCE CANALETTO VERNICIATO.
<b>APERTURA</b>	MANIGLIA LATERALE IN ZAMA VERNICICATO NICKEL LUCIDO O BRONZO.
<b>OPTIONALS</b>	FASCIA DECORATA: VETRO DI VARIE DECORAZIONI (SILVER, GOLD, SAHARA NOIRE, KALACATTA O SPECCHIO FUME') SP. 3MM

#### HOLA WARDROBE 2 SLIDING DOORS WITH OR WITHOUT MIRRORS

<b>DOORS</b>	FRONT PANEL IN CANALETTO WALNUT VENEERED MULTILAYER SP. 0,8 CM AND STRUCTURE IN TANGANICA WALNUT STRUCTURE OF 1,8 CM PAINTED.
<b>HORIZONTAL DECORATION</b>	SOLID STRIPS IN CANALETTO WALNUT
<b>OPENING</b>	LATERAL HANDLE IN ZAMAK PAINTED POLISHED NICKEL OR BRONZE.
<b>OPTIONALS</b>	DECORATED BAND: GLASS OF VARIOUS DECORATIONS (SILVER, GOLD, SAHARA NOIRE, KALACATTA OR SMOKED MIRROR ') SP. 3MM

#### JAZZ

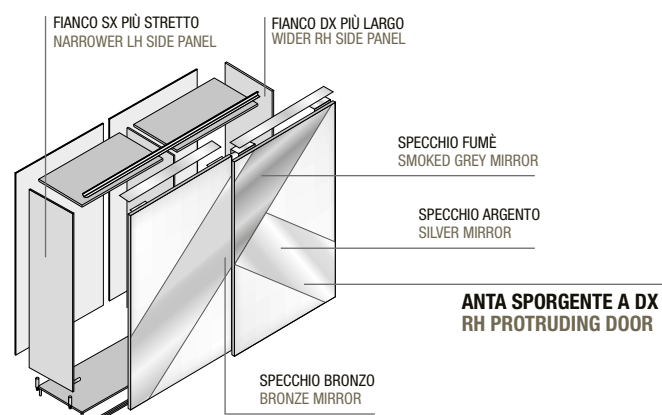

**ANTA SPORGENTE A DX RH PROTRUDING DOOR**

#### ARMADIO JAZZ 2 ANTE SCORREVOLI

<b>ANTE</b>	PANNELLO FRONTALE DI MULTISTRATI IMPIALLACCIATO NOCE CANALETTO SP. 0,8 CM E STRUTTURA IN LISTELLARE DI NOCE TANGANICA DA CM 1,8 VERNICIATO. SPECCHIO ARGENTO, BRONZO E FUMÉ.
<b>APERTURA</b>	MANIGLIA LATERALE IN ZAMA VERNICICATO NICKEL LUCIDO O BRONZO.

#### JAZZ WARDROBE WITH 2 SLIDING DOORS

<b>DOORS</b>	HOLLOW-CORE PANEL WITH FIR FRAME AND MULTILAYER OF POPLAR WATER PAINTED. GLOSSY NICKEL HANDLE. SILVER AND SMOKED GREY MIRROR, WITH THE POSSIBILITY TO INSERT THE DECORATION IN SOLID ASHWOOD INSTEAD OF HORIZONTAL MIRROR.
<b>OPENING</b>	LATERAL HANDLE IN ZAMAK PAINTED POLISHED NICKEL OR BRONZE.

CARATTERISTICHE TECNICHE  
TECHNICAL CHARACTERISTICS

VERSIONE CON 2 SPECCHI E DOGA LEGNO  
VERSION WITH 2 MIRRORS AND WOODEN SLAT

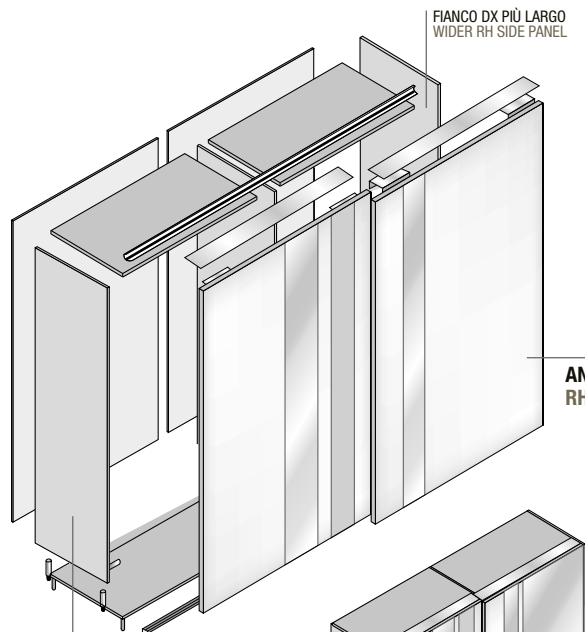

VERSIONE CON 3 SPECCHI E DOGA LEGNO  
VERSION WITH 3 MIRRORS AND WOODEN SLAT

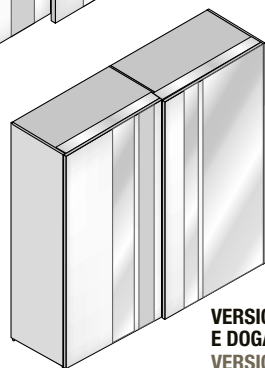

ARMADIO DOMINO 2 ANTE SCORREVOLI

**ANTE** PANNELLO FRONTALE DI MULTISTRATI IMPIALLACCIATO NOCE CANALETTO SP. CM 0,8 E STRUTTURA IN LISTELLARE DI NOCE TANGANICA DA CM. 1,8 VERNICIATO. DOGHE LEGNO LISCIO, RIGHE O LEGNO QUADRO IN PANNELLO DI MULTISTRATI IMPIALLACCIATO NOCE CANALETTO, VERNICIATO. MANIGLIA LATERALE IN ZAMA NICHEL LUCIDO O BRONZO. SPECCHIO BRONZO O ARGENTO

**APERTURA** MANIGLIA LATERALE IN ZAMA VERNICATO NICKEL LUCIDO O BRONZO.

DOMINO WARDROBE WITH 2 SLIDING DOORS

**DOORS** FRONT PANEL IN MULTILAYER WITH CANALETTO WALNUT VENEER TH. CM 0.8 E STRUCTURE IN TANGANICA WALNUT LISTEL FROM CM. 1.8 PAINTED. PLAIN WOODEN SLATS, STRIPED OR SQUARE WOOD IN MULTILAYER PANEL VENEERED IN CANALETTO WALNUT, PAINTED. LATERAL HANDLE IN ZAMA NICKEL GLOSSY OR BRONZE. BRONZE NAD SILVER MIRROR

**OPENING** LATERAL HANDLE IN ZAMAK PAINTED POLISHED NICKEL OR BRONZE.

VERSIONE CON 2 SPECCHI  
VERSION WITH 2 MIRRORS

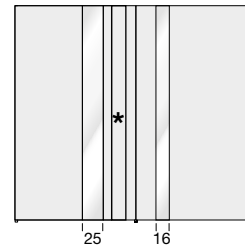

DOGA LEGNO LISCIA  
PLAIN WOODEN SLAT

VERSIONE CON 3 SPECCHI  
VERSION WITH 3 MIRRORS

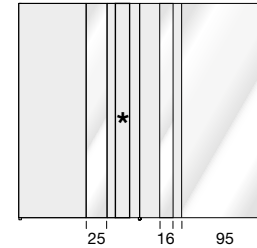

DOGA QUADRO LEGNO  
WOODEN SQUARE SLAT

**N.B.: NELLA DOGA QUADRO VERTICALE IL DECORO NON SI PRESENTA IN TUTTA LUNGHEZZA MA SOLO NELLA METÀ INFERIORE DELL'ANTA**  
N.B.: DECORATION ON THE VERTICAL SQUARE SLAT COVERS JUST THE BOTTOM HALF OF THE DOOR, NOT THE ENTIRE LENGTH.

ARMADIO SWING 2 ANTE SCORREVOLI

**ANTE SWING** PANNELLO FRONTALE DI MULTISTRATI IMPIALLACCIATO NOCE CANALETTO SP. CM 0,8 E STRUTTURA IN LISTELLARE DI NOCE TANGANICA DA CM. 1,8 VERNICIATO. DOGHE LEGNO LISCIO, RIGHE O LEGNO QUADRO IN PANNELLO DI MULTISTRATI IMPIALLACCIATO NOCE CANALETTO, VERNICIATO. SPECCHIO BRONZO O ARGENTO

**APERTURA** MANIGLIA LATERALE IN ZAMA VERNICATO NICKEL LUCIDO O BRONZO.

SWING WARDROBE WITH 2 SLIDING DOORS

**SWING DOORS** FRONT PANEL IN MULTILAYER WITH CANALETTO WALNUT VENEER TH. CM 0.8 E STRUCTURE IN TANGANICA WALNUT LISTEL FROM CM. 1.8 PAINTED. PLAIN WOODEN SLATS, STRIPED OR SQUARE WOOD IN MULTILAYER PANEL VENEERED IN CANALETTO WALNUT, PAINTED. BRONZE NAD SILVER MIRROR

**OPENING** LATERAL HANDLE IN ZAMAK PAINTED POLISHED NICKEL OR BRONZE.

DOGA ORIZZONTALE  
HORIZONTAL SLAT

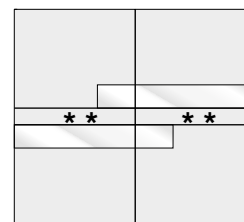

DOGA LEGNO LISCIA  
PLAIN WOODEN SLAT



DOGA RIGHE  
STRIPED SLAT



DOGA QUADRO LEGNO  
WOODEN SQUARE SLAT

**N.B.: NELLA DOGA QUADRO ORIZZONTALE IL DECORO SI PRESENTA AL CENTRO E FINISCE AI LATI CON RIGHE CONTINUE**  
N.B.: DECORATION ON THE HORIZONTAL SQUARE SLAT IS IN THE MIDDLE AND FINISHES ON SIDES WITH CONTINUOUS STRIPES

DOMINO

SWING

# NOTTE - NIGHT

## CARATTERISTICHE TECNICHE TECHNICAL CHARACTERISTICS

### ARMADI WARDROBES

#### FERRAMENTA PER ARMADI SCORREVOLI HARDWARE FOR SLIDING WARDROBES

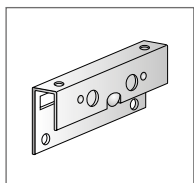

PATTINO SUPERIORE PER ANTA INTERNA  
TOP RUNNER FOR INTERNAL DOOR

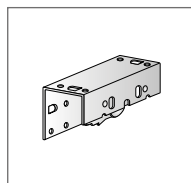

CARRELLO SUPERIORE ANTA  
DOOR TOP RUNNER

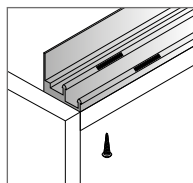

BINARIO SUPERIORE  
TOP TRACK

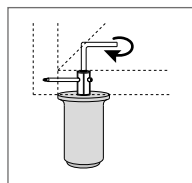

PIEDE REGOLATORE  
ADJUSTABLE FOOT

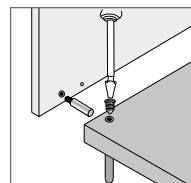

MONTAGGIO PIEDE REGOLATORE  
ADJUSTABLE FOOT ASSEMBLY

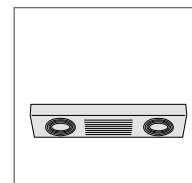

DEPURATORE D'ARIA CON SISTEMA AIRLIGHTPRO UV-A (OPTIONAL)  
AIR PURIFIER WITH UV-A AIRLIGHTPRO SYSTEM

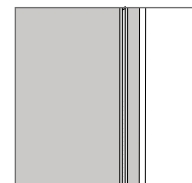

BARRA LED IN ALLUMINIO CON LUCE CALDA  
ALUMINUM LED BAR WITH WARM LIGHT (OPTIONAL)

#### VANI INTERNI - ARMADI 2 ANTE SCORREVOLI E 4 ANTE BATTENTE INTERNAL COMPARTMENT - 2 SLIDING DOOR AND 4 HINGED DOOR WARDROBES

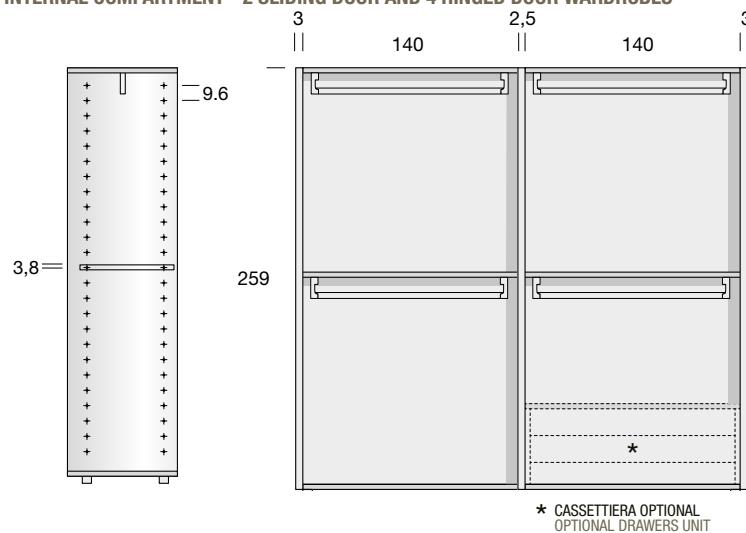

#### VANI INTERNI ARMADIO 6 ANTE BATTENTE INTERNAL COMPARTMENT FOR 6 HINGED DOORS

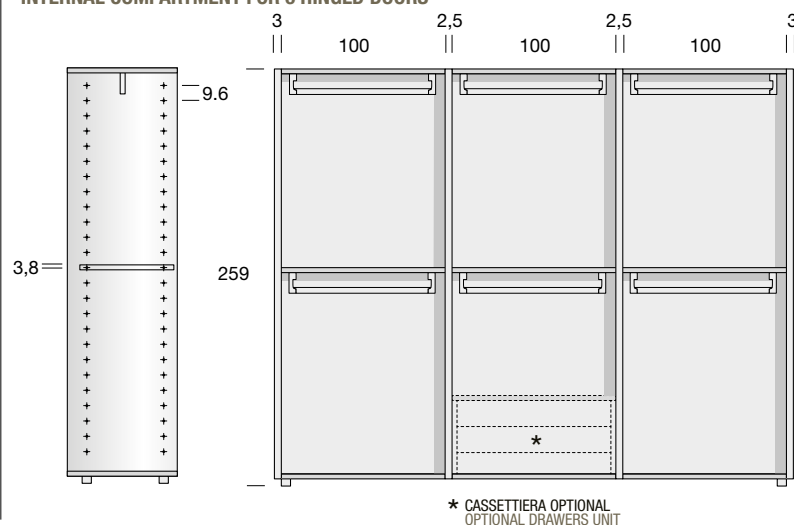

#### REGOLAZIONE ANTE SCORREVOLI PRIMA DEL MONTAGGIO SLIDING DOOR ADJUSTMENT BEFORE ASSEMBLY

PRIMA DI PROCEDERE AL MONTAGGIO, BISOGNA REGOLARE LA TENSIONE DELLE ANTE POSIZIONANDOLE OBBLIGATORIAMENTE IN ORIZZONTALE E UTILIZZANDO UN CACCIAVITE O UN PUNTERUOLO.

BEFORE ASSEMBLING REGULATE DOOR TENSION BY PLACING THEM HORIZONTALLY AND USING THE SPECIAL SPANNER PROVIDED.

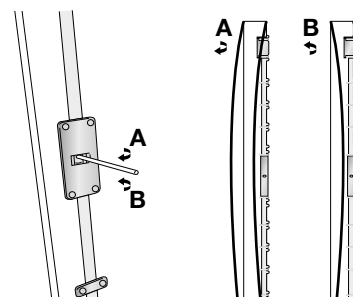

#### MONTAGGIO ANTE SCORREVOLI SLIDING DOOR ASSEMBLY

PER POTER AGGANCIARE LE ANTE AL BINARIO SUPERIORE TRA IL SOFFITTO E L'ARMADIO CI DEVONO ESSERE ALMENO 3 CM.

LEAVE AT LEAST 3CM CLEARANCE SO THAT THE DOORS CAN BE ATTACHED TO THE UPPER RAIL BETWEEN THE CEILING AND WARDROBE.

- 1 AGGANCIARE L'ANTA AL BINARIO SUPERIORE  
FASTEN THE DOOR TO THE TOP TRACK
- 2 SPINGERE L'ANTA NEL BINARIO INFERIORE  
PUSH THE DOOR IN THE LOW TRACK

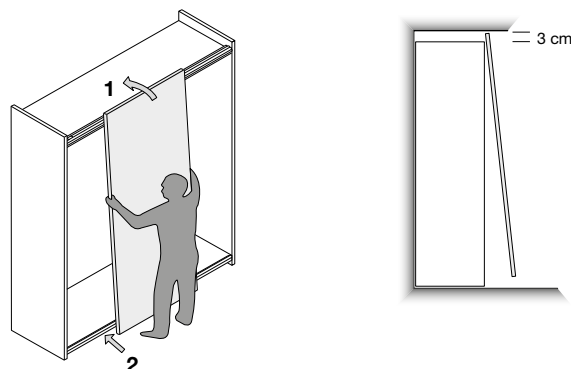

#### SMONTAGGIO ANTE SCORREVOLI REMOVAL SLIDING DOORS

PER SBLOCCARE LE ANTE DAL SISTEMA DI BLOCCAGGIO DI SICUREZZA È NECESSARIO AVVITARE IL GRANO (1), LA LINGUETTA (2) SI SPOSTA AUTOMATICAMENTE E SARÀ POSSIBILE SGANCIARE LE ANTE.

TO RELEASE THE DOORS FROM THE SAFETY LOCKING SYSTEM YOU NEED TO TIGHTEN THE SPECIAL SCREW(1), THE TAB (2) AUTOMATICALLY MOVES AND THE DOORS CAN BE RELEASED

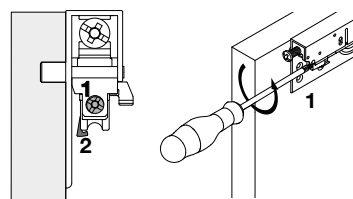



## CARATTERISTICHE TECNICHE TECHNICAL CHARACTERISTICS

### SPECCHIERE MIRRORS

**DOMINO**

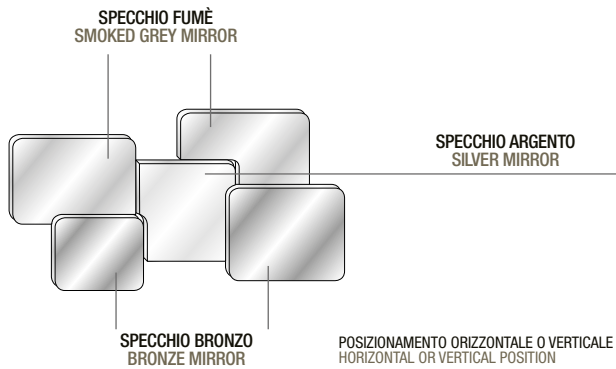

#### SPECCHIERA

PANNELLO DI MDF SP.1.8, LACCATO NERO. SPECCHI ARGENTO, BRONZO, FUME.  
POSIZIONAMENTO ORIZZONTALE O VERTICALE  
SPECCHIO SPESSORE SP. CM. 0.4.

#### MIRROR

MDF PANEL TH.1.8, BLACK LACQUERED. SILVER, BRONZE, FUME MIRRORS.  
HORIZONTAL OR VERTICAL POSITION.  
MIRROR THICKNESS TH. CM. 0.4.

**PEDRERA**

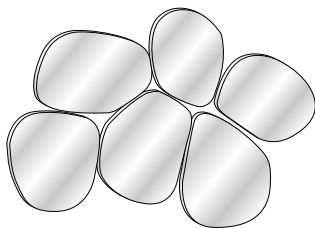

SPECCHIO ARGENTO  
SILVER MIRROR

#### SPECCHIERA

PANNELLO DI MDF SP.1.8, LACCATO NERO. SPECCHI ARGENTO  
SPECCHIO SPESSORE SP. CM. 0.4.

#### MIRROR

MDF PANEL TH.1.8, BLACK LACQUERED. SILVER MIRRORS.  
MIRROR THICKNESS TH. CM. 0.4.

**SHANGHAI**

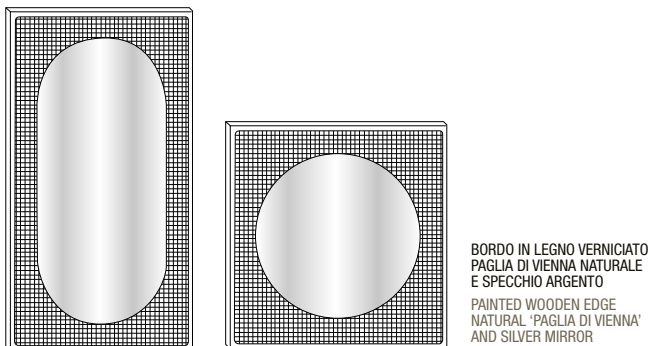

#### SPECCHIERA

PANNELLO DI MDF IMPIALLACCIATO NOCE CANALETTO FINITURA NATURALE.  
RIVESTIMENTO IN MIDOLLINO INTRECCIATO "PAGLIA DI VIENNA"  
SPECCHIO ARGENTO

#### MIRROR

CANALETTO WALNUT VENEER PANEL NATURAL FINISH. "VIENNA STRAW"  
WOVEN WICKER COVERING SILVER MIRROR

**SINGAPORE**

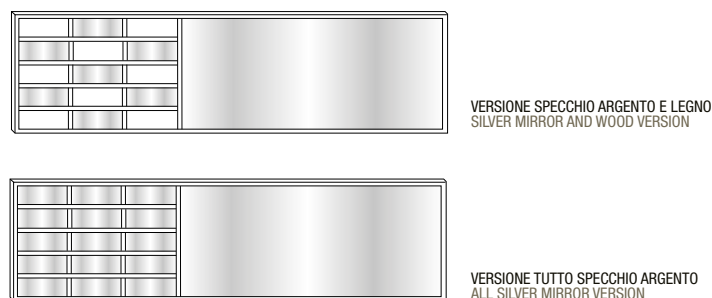

#### SPECCHIERA

PANNELLO DI LISTELLARE IMPIALLACCIATO NOCE CANALETTO E BORDATO SP. CM 3.  
SPECCHIO ARGENTO  
VERSIONE SPECCHIO E LEGNO: ELEMENTI DECORATIVI IN LEGNO MASSELLO DI NOCE CANALETTO E  
PANNELLI IN MULTISTRATO IMPIALLACCIATO NOCE CANALETTO  
VERSIONE TUTTO SPECCHIO: ELEMENTI DECORATIVI IN LEGNO MASSELLO DI NOCE CANALETTO.

#### MIRROR

STRIP PANEL VENEERED CANALETTO WALNUT AND EDGED TH. CM 3.  
SILVER MIRROR  
MIRROR AND WOOD VERSION: DECORATIVE ELEMENTS IN SOLID CANALETTO WALNUT AND  
PANELS IN CANALETTO WALNUT VENEERED MULTILAYER  
FULL MIRROR VERSION: DECORATIVE ELEMENTS IN SOLID CANALETTO WALNUT.

**THAI**

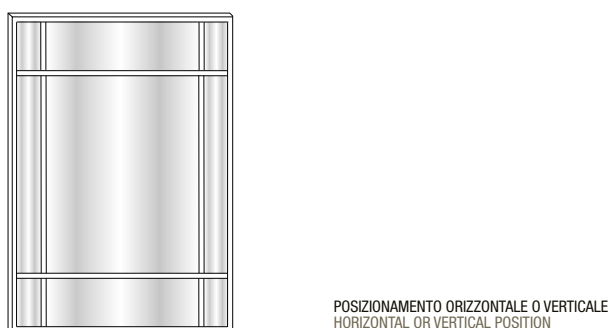

#### SPECCHIERA

PANNELLO DI MDF IMPIALLACCIATO NOCE CANALETTO E BORDATO.  
ELEMENTI DECORATIVI IN LEGNO MASSELLO DI NOCE CANALETTO.  
SPECCHIO ARGENTO

#### MIRROR

CANALETTO WALNUT AND EDGED MDF PANEL.  
DECORATIVE ELEMENTS IN SOLID CANALETTO WALNUT WOOD.  
SILVER MIRROR

# NOTTE E GIORNO - NIGHT AND DAY

## CARATTERISTICHE TECNICHE TECHNICAL CHARACTERISTICS

### POLTRONA, POUF E PANCHETTA ARMCHAIR, POUF AND BENCH

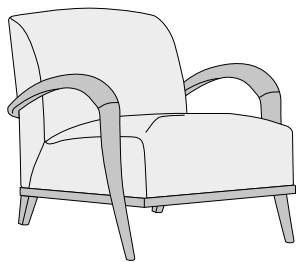

#### POLTRONA

- BRACCIOLI E BASE** IN MASSELLO DI NOCE CANALETTO.
- SEDILE** CON CINGHIE, POLIURETANO ESPANSO PF/35, MEMORY, DRACOM DOUPHON, TELA DI COTONE E RIVESTIMENTO DA CAMPIONARIO.
- SCHIENALE** CON POLIURETANO ESPANSO EET/21, MEMORY, DRACOM DOUPHON, TELA DI COTONE E RIVESTIMENTO DA CAMPIONARIO.

#### ARMCHAIR

- ARMS AND BASE** SOLID CANALETTO WALNUT
- SEAT** WITH BELT, MEMORY, POLYURETHANE FOAM P/F 35, DRACOM DOUPHON, COTTON CANVAS AND COVER SAMPLES
- BACK** WITH POLYURETHANE FOAM EET/21, MEMORY, DRACOM DOUPHON, COTTON CANVAS AND COVER SAMPLES.

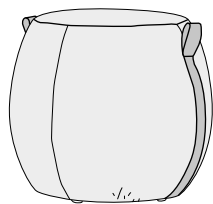

#### POUF

- BASE** IN PANNELLO DI MULTISTRATO PIOPPO, POLIURETANO ESPANSO ET/30, FALDA IN RESINATO.
- CINGHIE** IN CUIO E RIVESTIMENTO CON TESSUTI DA CAMPIONARIO.

#### POUF

- BASE** IN POPLAR MULTILAYER PANEL, POLYURETHANE FOAM ET/30, RESIN STRATUM
- BELTS** LEATHER AND COVER SAMPLES

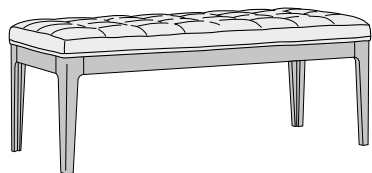

#### PANCHETTA E SGABELLO

- STRUTTURA** IN LEGNO MASSELLO DI NOCE CANALETTO.
- IMBOTTITURA** GOMMAPIUMA E RIVESTIMENTO DA CAMPIONARIO.

#### BENCH AND STOOL

- STRUCTURE** IN SOLID CANALETTO WALNUT.
- PADDING** FOAM AND COVER SAMPLES

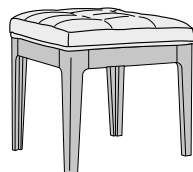

### POLTRONA E DIVANI BUDDY BUDDY ARMCHAIR AND SOFAS

#### POLTRONA ARMCHAIR

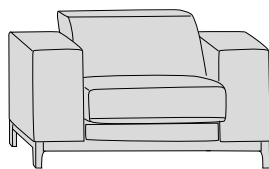

#### DIVANO 2 O 3 POSTI 2 OR 3-SEATER SOFA

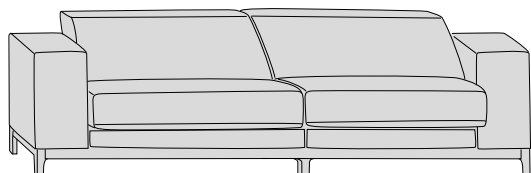

#### POLTRONA E DIVANI

- FUSTO:** MULTISTRATO DI PIOPPO E LEGNO DI ABETE
- IMBOTTITURA:** SEDUTE IN POLIURETANO ESPANSO D. 35 MS RIVESTITE IN LANA SINTETICA E FALDA SINTETICA. SPALLIERE IN POLIURETANO ESPANSO D.18 MS RIVESTITO IN LANA SINTETICA E FALDA SINTETICA
- PIEDE:** LEGNO MASSELLO DI FAGGIO, VERNICIATO (NON POSSIBILE PER LA FINITURA CANALETTO OLIO E HAVANA, RICHIEDERE PREVENTIVO)

#### ARMCHAIR AND SOFAS

- STRUCTURE:** MULTILAYER OF POPLAR AND FIR WOOD
- PADDING:** SEATS IN EXPANDED POLYURETHANE D. 35 MS COVERED IN SYNTHETIC WOOL AND SYNTHETIC FALDA. BACK IN POLYURETHANE EXPANDED D.18 MS COVERED IN SINTETIC WOOL AND SYNTHETIC WARM
- BASEMENT:** SOLID BEECH WOOD, PAINTED (NOT POSSIBLE FOR FINISHING CANALETTO OIL AND HAVANA, REQUEST A QUOTE)

BUDDY

CARATTERISTICHE TECNICHE  
TECHNICAL CHARACTERISTICS

CREDENZE E PORTA TV  
SIDEBOARDS AND TV UNIT

CREDENZA 2 E 3 ANTE  
SIDEBOARD WITH 2 AND 3 DOORS

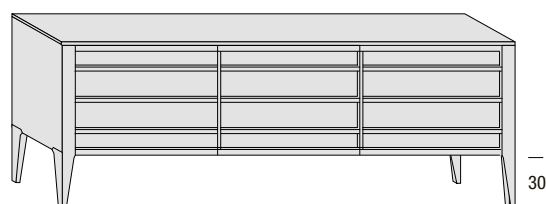

PORTA TV  
TV UNIT

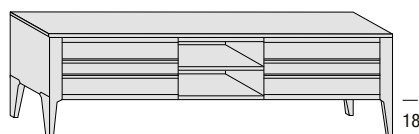

SHANGHAI

CREDENZA 2, 3 ANTE E PORTA TV

<b>STRUTTURA:</b>	PANNELLO DI LISTELLARE ESTERNO RIVESTITO IN NOCE CANALETTO E INTERNO RIVESTITO IN NOCE TANGANICA
<b>TOP:</b>	PANNELLO DI LISTELLARE RIVESTITO E BORDATO IN NOCE CANALETTO SP. 1.8
<b>ANTE LEGNO:</b>	PANNELLO DI LISTELLARE RIVESTITO E BORDATO IN NOCE CANALETTO SP. CM 1,8 LISTELLI ORIZZONTALI IN MASSELLO DI NOCE CANALETTO.
<b>SPALLE:</b>	LEGNO FJ RIVESTITO NOCE CANALETTO SEZIONE 60/70X25
<b>PIEDI POSTERIORI:</b>	MASSELLO DI NOCE CANALETTO
<b>SCHIENALI:</b>	PANNELLO DI MULTISTRATO NOCE TANGANICA
<b>MANIGLIA:</b>	IN MASSELLO DI NOCE CANALETTO INTEGRATA NEL FRONTALE
<b>RIPIANI:</b>	VETRO
<b>OPTIONAL FRONTALI:</b>	VETRO DI VARIE DECORAZIONI (SILVER/GOLD/SAHARA NOIRE, KALACATTA) SP. 3MM
<b>OPTIONAL PIANI:</b>	VETRO EFFETTO MARMO (SAHARA NOIRE, KALACATTA) O VETRO FUMÉ SP. 3MM

SIDEBOARD WITH 2, 3 DOORS AND TV UNIT

<b>STRUCTURE:</b>	BLOCKBOARD PANEL: OUTSIDE COVERED IN CANALETTO WALNUT, INSIDE COVERED IN TANGANICA WALNUT
<b>TOP:</b>	STRIP PANEL COATED AND EDGED IN CANALETTO WALNUT SP. CM 1.8
<b>WOODEN DOORS:</b>	STRIP PANEL COVERED AND EDGED IN CANALETTO WALNUT SP. CM 1.8 HORIZONTAL STRIPS IN SOLID CANALETTO WALNUT.
<b>SUPPORT PANELS:</b>	FJ WOOD COVERED IN CANALETTO WALNUT 60/70X25 SECTION
<b>BACK FEET:</b>	SOLID CANALETTO WALNUT
<b>BACK PANELS:</b>	MULTILAYER PANEL IN TANGANICA WALNUT
<b>HANDLE:</b>	SOLID CANALETTO WALNUT HANDLE INTEGRATED IN THE FRONT
<b>SHELVES:</b>	GLASS
<b>FRONTAL OPTIONALS:</b>	GLASS OF VARIOUS DECORATIONS (SILVER / GOLD / SAHARA NOIRE, KALACATTA) OR SMOKED GLASS TH. 3MM
<b>TOP OPTIONAL:</b>	GLASS MARBLE EFFECT (SAHARA NOIRE, KALACATTA) TH. 3MM

CREDENZA 2 E 3 ANTE  
SIDEBOARD WITH 2 AND 3 DOORS

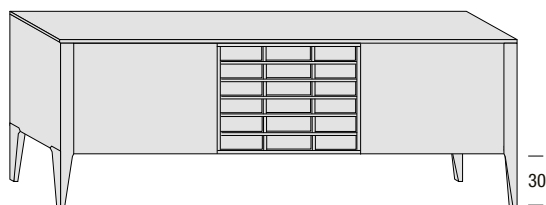
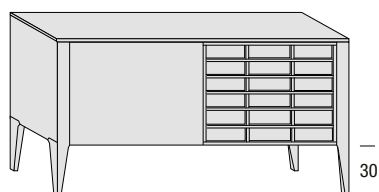

SINGAPORE

CREDENZA 2 E 3 ANTE

<b>STRUTTURA:</b>	PANNELLO DI LISTELLARE ESTERNO RIVESTITO IN NOCE CANALETTO E INTERNO RIVESTITO IN NOCE TANGANICA
<b>TOP:</b>	PANNELLO DI LISTELLARE RIVESTITO E BORDATO IN NOCE CANALETTO SP. 1.8
<b>ANTE LEGNO:</b>	PANNELLO DI LISTELLARE RIVESTITE E BORDATE IN NOCE CANALETTO SP. CM 1,8 LISTELLI ORIZZONTALI IN MASSELLO DI NOCE CANALETTO.
<b>SPALLE:</b>	LEGNO FJ RIVESTITO NOCE CANALETTO SEZIONE 60/70X25
<b>PIEDI POSTERIORI:</b>	MASSELLO DI NOCE CANALETTO
<b>SCHIENALI:</b>	PANNELLO DI MULTISTRATO NOCE TANGANICA
<b>APERTURE:</b>	MANIGLIA IN MASSELLO DI NOCE CANALETTO INTEGRATA SU ANTA DECORATA E PUSH-PULL SU ANTA LISCIA
<b>RIPIANI:</b>	VETRO
<b>OPTIONAL PIANI:</b>	VETRO EFFETTO MARMO (SAHARA NOIRE, KALACATTA)

SIDEBOARD WITH 2 AND 3 DOORS

<b>STRUCTURE:</b>	BLOCKBOARD PANEL: OUTSIDE COVERED IN CANALETTO WALNUT, INSIDE COVERED IN TANGANICA WALNUT
<b>TOP:</b>	PANNELLO DI LISTELLARE RIVESTITO E BORDATO IN NOCE CANALETTO SP. CM 1.8
<b>WOODEN DOORS:</b>	STRIP PANEL COVERED AND EDGED IN CANALETTO WALNUT SP. CM 1.8 HORIZONTAL STRIPS IN SOLID CANALETTO WALNUT.
<b>SUPPORT PANELS:</b>	FJ WOOD COVERED IN CANALETTO WALNUT 60/70X25 SECTION
<b>BACK FEET:</b>	SOLID CANALETTO WALNUT
<b>BACK PANELS:</b>	MULTILAYER PANEL IN TANGANICA WALNUT
<b>OPENING:</b>	SOLID CANALETTO WALNUT HANDLE INTEGRATED ON DECORATED DOOR AND PUSH-PULL ON SMOOTH DOOR
<b>SHELVES:</b>	GLASS
<b>TOP OPTIONAL:</b>	GLASS MARBLE EFFECT (SAHARA NOIRE, KALACATTA)

### CREDENZE E PORTA TV SIDEBOARDS AND TV UNIT

#### CREDENZA 2 E 3 ANTE SIDEBOARD WITH 2 AND 3 DOORS

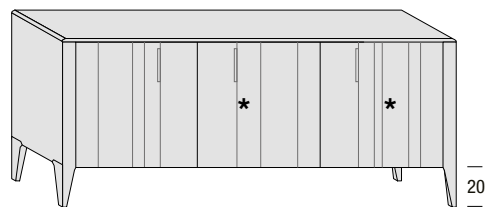
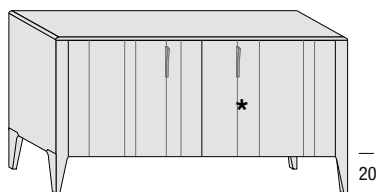

#### PORTA TV 2 ANTE LEGNO E VANO A GIORNO TV UNIT WITH 2 WOODEN DOORS AND OPEN COMPARTMENT

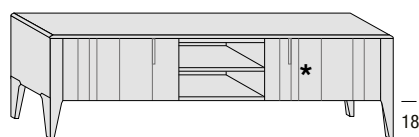

DOMINO



\* DOGA LEGNO LISCIA  
PLAIN WOODEN SLAT



\* DOGA RIGHE  
STRIPED SLAT



\* DOGA QUADRO LEGNO  
WOODEN SQUARE SLAT

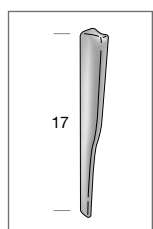

MANIGLIA GRANDE  
LARGE HANDLE

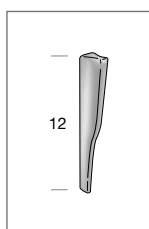

MANIGLIA PICCOLA  
SMALL HANDLE

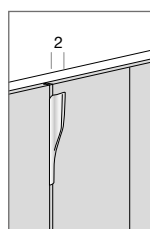

INCASTRO MANIGLIA  
HANDLE JOINT

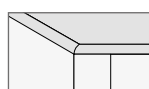

DETTAGLIO TOP SAGOMATO  
SHAPED TOP DETAIL

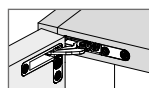

CERNIERA AIR  
AIR HINGE

#### CREDENZA 2 E 3 ANTE

<b>STRUTTURA:</b>	PANNELLO DI LISTELLARE ESTERNO RIVESTITO IN NOCE CANALETTO E INTERNO RIVESTITO IN NOCE TANGANICA
<b>TOP:</b>	PANNELLO DI LISTELLARE RIVESTITO NOCE CANALETTO E STRUTTURA PERIMETRALE IN MASSELLO DI NOCE CANALETTO, SP. 1.8
<b>ANTE LEGNO:</b>	PANNELLO DI LISTELLARE RIVESTITE INTERNAMENTE IN NOCE CANALETTO ED ESTERNAMENTE IN NOCE TANGANICA SP. 2.9 CM – CON DOGE IN MULTISTRATI RIVESTITTE NOCE CANALETTO E LATI IN MASSELLO DI NOCE CANALETTO SP. 0.3 CM – RIPIANI INTERNI VETRO
<b>SPALLE:</b>	LEGNO FJ RIVESTITO NOCE CANALETTO SEZIONE 60/70X25
<b>PIEDI POSTERIORI:</b>	MASSELLO DI NOCE CANALETTO
<b>SCHIENALI:</b>	PANNELLO DI MULTISTRATO NOCE TANGANICA
<b>MANIGLIA:</b>	MANIGLIA DOMINO SU DISEGNO

#### SIDEBOARD WITH 2 AND 3 DOORS

<b>STRUCTURE:</b>	BLOCKBOARD PANEL: OUTSIDE COVERED IN CANALETTO WALNUT, INSIDE COVERED IN TANGANICA WALNUT
<b>TOP:</b>	BLOCKBOARD PANEL COVERED IN CANALETTO WALNUT AND PERIMETRIC STRUCTURE IN SOLID CANALETTO WALNUT, TH. 1.8
<b>WOODEN DOORS:</b>	BLOCKBOARD PANEL COVERED INSIDE IN CANALETTO WALNUT AND OUTSIDE IN TANGANICA WALNUT TH. 2.9 CM – WITH MULTILAYER SLAT COVERED IN CANALETTO WALNUT AND SIDES IN SOLID CANALETTO WALNUT TH. 0.3 CM – INSIDE GLASS SHELVES
<b>SUPPORT PANELS:</b>	FJ WOOD COVERED IN CANALETTO WALNUT 60/70X25 SECTION
<b>BACK FEET:</b>	SOLID CANALETTO WALNUT
<b>BACK PANELS:</b>	MULTILAYER PANEL IN TANGANICA WALNUT
<b>HANDLE:</b>	DOMINO HANDLE AS IN THE DRAWING

#### PORTA TV 2 ANTE E VANO A GIORNO

<b>STRUTTURA:</b>	PANNELLO DI LISTELLARE ESTERNO RIVESTITO IN NOCE CANALETTO E INTERNO RIVESTITO IN NOCE TANGANICA
<b>TOP:</b>	PANNELLO DI LISTELLARE RIVESTITO NOCE CANALETTO E STRUTTURA PERIMETRALE IN MASSELLO DI NOCE CANALETTO, SP. 1.8
<b>ANTE LEGNO:</b>	PANNELLO DI LISTELLARE RIVESTITE INTERNAMENTE IN NOCE CANALETTO ED ESTERNAMENTE IN NOCE TANGANICA SP. 2.9 CM – CON DOGE IN MULTISTRATI RIVESTITTE NOCE CANALETTO E LATI IN MASSELLO DI NOCE CANALETTO SP. 0.3 CM – RIPIANI INTERNI VETRO
<b>SPALLE:</b>	LEGNO FJ RIVESTITO NOCE CANALETTO SEZIONE 60/70X25
<b>PIEDI POSTERIORI:</b>	MASSELLO DI NOCE CANALETTO
<b>SCHIENALI:</b>	PANNELLO DI MULTISTRATO NOCE CANALETTO
<b>MANIGLIA:</b>	MANIGLIA DOMINO SU DISEGNO

#### TV UNIT WITH 2 DOORS AND OPEN COMPARTMENT

<b>STRUCTURE:</b>	BLOCKBOARD PANEL: OUTSIDE COVERED IN CANALETTO WALNUT, INSIDE COVERED IN TANGANICA WALNUT
<b>TOP:</b>	BLOCKBOARD PANEL COVERED IN CANALETTO WALNUT AND PERIMETRIC STRUCTURE IN SOLID CANALETTO WALNUT, TH. 1.8
<b>WOODEN DOORS:</b>	BLOCKBOARD PANEL COVERED INSIDE IN CANALETTO WALNUT AND OUTSIDE IN TANGANICA WALNUT TH. 2.9 CM – WITH MULTILAYER SLAT COVERED IN CANALETTO WALNUT AND SIDES IN SOLID CANALETTO WALNUT TH. 0.3 CM – INSIDE GLASS SHELVES
<b>SUPPORT PANELS:</b>	FJ WOOD COVERED IN CANALETTO WALNUT 60/70X25 SECTION
<b>BACK FEET:</b>	SOLID CANALETTO WALNUT
<b>BACK PANELS:</b>	MULTILAYER PANEL IN CANALETTO WALNUT
<b>HANDLE:</b>	DOMINO HANDLE AS IN THE DRAWING

CARATTERISTICHE TECNICHE  
TECHNICAL CHARACTERISTICS

MADIE E VETRINE  
DISPLAY UNITS

MADIA 2 ANTE LEGNO  
DISPLAY UNIT WITH 2 WOODEN DOORS

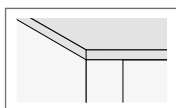

DETTAGLIO TOP DRITTO  
STRAIGHT TOP DETAIL

VETRINA 2 ANTE VETRO  
DISPLAY UNIT WITH 2 GLASS DOORS

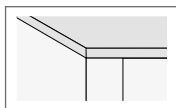
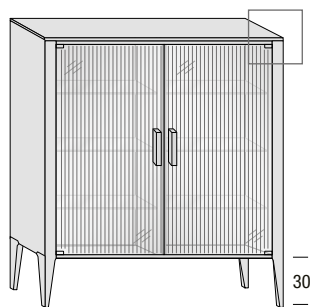

DETTAGLIO TOP DRITTO  
STRAIGHT TOP DETAIL

MADIA 2 ANTE

<b>STRUTTURA:</b>	PANNELLO DI LISTELLARE ESTERNO RIVESTITO IN NOCE CANALETTO E INTERNO RIVESTITO IN NOCE TANGANICA
<b>TOP:</b>	PANNELLO DI LISTELLARE RIVESTITO E BORDATO IN NOCE CANALETTO SP. 1.8
<b>ANTE LEGNO:</b>	PANNELLO DI LISTELLARE RIVESTITE E BORDATE IN NOCE CANALETTO SP. CM 1,8 LISTELLI ORIZZONTALI IN MASSELLO DI NOCE CANALETTO.
<b>SPALLE:</b>	LEGNO FJ RIVESTITO NOCE CANALETTO SEZIONE 60/70X25
<b>PIEDI POSTERIORI:</b>	MASSELLO DI NOCE CANALETTO
<b>SCHIENALI:</b>	PANNELLO DI MULTISTRATO NOCE TANGANICA
<b>MANIGLIA:</b>	IN MASSELLO DI NOCE CANALETTO INTEGRATA NEL FRONTALE
<b>RIPIANI:</b>	VETRO
<b>OPTIONAL FRONTALI:</b>	VETRO DI VARIE DECORAZIONI (SILVER/GOLD/SAHARA NOIRE, KALACATTA) SP. 3MM
<b>OPTIONAL PIANI:</b>	VETRO EFFETTO MARMO (SAHARA NOIRE, KALACATTA) SP. 3MM

DISPLAY UNIT 2 DOORS

<b>STRUCTURE:</b>	BLOCKBOARD PANEL: OUTSIDE COVERED IN CANALETTO WALNUT, INSIDE COVERED IN TANGANICA WALNUT
<b>TOP:</b>	STRIP PANEL COATED AND EDGED IN CANALETTO WALNUT SP. CM 1.8
<b>WOODEN DOORS:</b>	STRIP PANEL COVERED AND EDGED IN CANALETTO WALNUT SP. CM 1.8 HORIZONTAL STRIPS IN SOLID CANALETTO WALNUT.
<b>SUPPORT PANELS:</b>	FJ WOOD COVERED IN CANALETTO WALNUT 60/70X25 SECTION
<b>BACK FEET:</b>	SOLID CANALETTO WALNUT
<b>BACK PANELS:</b>	MULTILAYER PANEL IN TANGANICA WALNUT
<b>OPENING:</b>	SOLID CANALETTO WALNUT HANDLE INTEGRATED IN THE FRONT
<b>SHELVES:</b>	GLASS
<b>FRONTAL OPTIONALS:</b>	GLASS OF VARIOUS DECORATIONS (SILVER / GOLD / SAHARA NOIRE / KALACATTA) TH. 3MM
<b>TOP OPTIONAL:</b>	GLASS MARBLE EFFECT (SAHARA NOIRE, KALACATTA) TH. 3MM

VETRINA 2 ANTE

<b>STRUTTURA:</b>	PANNELLO DI LISTELLARE ESTERNO RIVESTITO IN NOCE CANALETTO E INTERNO RIVESTITO IN NOCE TANGANICA
<b>TOP:</b>	PANNELLO DI LISTELLARE RIVESTITO E BORDATO IN NOCE CANALETTO SP. 1.8
<b>ANTE VETRO:</b>	VETRO CANNETÉ TRASPARENTE TEMPERATO SP CM 0,6
<b>SPALLE:</b>	LEGNO FJ RIVESTITO NOCE CANALETTO SEZIONE 60/70X25
<b>PIEDI POSTERIORI:</b>	MASSELLO DI NOCE CANALETTO
<b>SCHIENALE:</b>	SCHIENALE IN MULTISTRATI IMPIALLACCIATO NOCE CANALETTO
<b>MANIGLIA:</b>	IN MASSELLO DI NOCE CANALETTO SU DISEGNO
<b>RIPIANI:</b>	VETRO
<b>OPTIONAL PIANI:</b>	VETRO EFFETTO MARMO (SAHARA NOIRE, KALACATTA) SP. 3MM
<b>OPTIONAL:</b>	STRISCIA LED SUL TOP

DISPLAY UNIT 2 DOORS

<b>STRUCTURE:</b>	BLOCKBOARD PANEL: OUTSIDE COVERED IN CANALETTO WALNUT, INSIDE COVERED IN TANGANICA WALNUT
<b>TOP:</b>	STRIP PANEL COATED AND EDGED IN CANALETTO WALNUT SP. CM 1.8
<b>GLASS DOORS:</b>	TRANSPARENT TEMPERED CANNETÉ GLASS, 0.6 CM TH
<b>SUPPORT PANELS:</b>	FJ WOOD COVERED IN CANALETTO WALNUT 60/70X25 SECTION
<b>BACK FEET:</b>	SOLID CANALETTO WALNUT
<b>BACK PANEL:</b>	BACK PANEL IN MULTILAYER CANALETTO WALNUT
<b>HANDLE:</b>	SOLID CANALETTO WALNUT HANDLE ON DRAWING
<b>SHELVES:</b>	GLASS
<b>TOP OPTIONAL:</b>	GLASS MARBLE EFFECT (SAHARA NOIRE, KALACATTA) TH. 3MM
<b>OPTIONAL:</b>	LED STRIP ON THE TOP

## VETRINE DISPLAY UNITS

### VETRINA 2 ANTE LEGNO E 2 ANTE VETRO DISPLAY UNIT WITH 2 WOODEN DOORS AND 2 GLASS DOORS

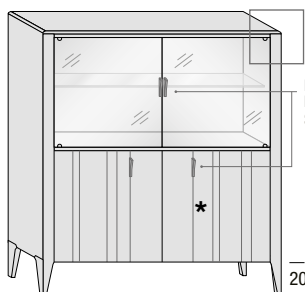

MANIGLIA DOMINO  
PICCOLA  
SMALL DOMINO HANDLE

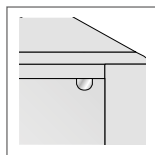

CERNIERA CHIUSURA  
ACCOMPAGNATA  
SOFT CLOSE HINGE



\* DOGA LEGNO LISCIA  
PLAIN WOODEN SLAT



\* DOGA RIGHE  
STRIPED SLAT



\* DOGA QUADRO LEGNO  
WOODEN SQUARE SLAT

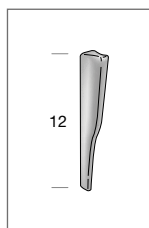

MANIGLIA PICCOLA  
SMALL HANDLE

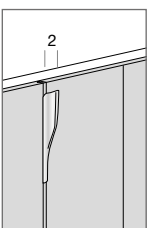

INCASTRO MANIGLIA  
HANDLE JOINT

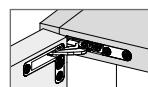

CERNIERA AIR  
AIR HINGE

### VETRINA 2 ANTE VETRO DISPLAY UNIT WITH 2 GLASS DOORS

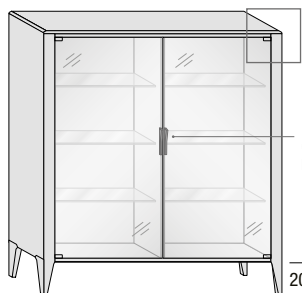

MANIGLIA DOMINO  
GRANDE  
LARGE DOMINO HANDLE

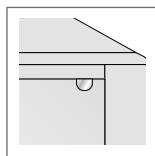

CERNIERA CHIUSURA  
ACCOMPAGNATA  
SOFT CLOSE HINGE

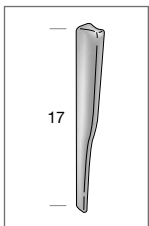

MANIGLIA GRANDE  
LARGE HANDLE

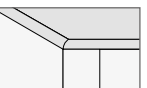

DETTAGLIO TOP SAGOMATO  
SHAPED TOP DETAIL

### VETRINA 2 ANTE LEGNO E 2 ANTE VETRO

<b>STRUTTURA:</b>	PANNELLO DI LISTELLARE ESTERNO RIVESTITO IN NOCE CANALETTO, INTERNO ANTE LEGNO RIVESTITO IN NOCE TANGANICA, INTERNO ANTE VETRO RIVESTITO IN NOCE CANALETTO
<b>TOP:</b>	PANNELLO DI LISTELLARE IMPIALLACCIATO NOCE CANALETTO E STRUTTURA PERIMETRALE IN MASSELLO DI NOCE CANALETTO, SP. 1.8
<b>ANTE LEGNO:</b>	PANNELLO DI LISTELLARE IMPIALLACCIATA INTERNAMENTE IN NOCE CANALETTO ED ESTERNAMENTE IN NOCE TANGANICA SP. 2.9 CM - CON DOGE IN MULTISTRATI IMPIALLACCIATO NOCE CANALETTO E LATI IN MASSELLO DI NOCE CANALETTO SP. 0.3 CM
<b>ANTE VETRO:</b>	VETRO TEMPERATO S.P 0.6 CM - RIPIANI INTERNI VETRO
<b>SPALLE:</b>	LEGNO FJ RIVESTITO NOCE CANALETTO SEZIONE 60/70X25
<b>PIEDI POSTERIORI:</b>	MASSELLO DI NOCE CANALETTO
<b>SCHIENALI:</b>	SCHIENALE INTERNO ANTE LEGNO IN MULTISTRATO NOCE TANGANICA SCHIENALE INTERNO ANTE VETRO IN MULTISTRATI DI NOCE CANALETTO
<b>APERTURA:</b>	MANIGLIA DOMINO SU DISEGNO IN ZAMA VERNICIATO

### DISPLAY UNIT WITH 2 WOODEN DOORS AND 2 GLASS DOORS

<b>STRUCTURE:</b>	BLOCKBOARD PANEL: OUTSIDE COVERED IN CANALETTO WALNUT, INSIDE OF WOODEN DOOR COVERED IN TANGANICA WALNUT, INSIDE OF GLASS DOORS COVERED IN CANALETTO WALNUT
<b>TOP:</b>	BLOCKBOARD PANEL VENEERED IN CANALETTO WALNUT AND PERIMETRIC STRUCTURE IN SOLID CANALETTO WALNUT, TH. 1.8
<b>WOODEN DOORS:</b>	BLOCKBOARD PANEL: INSIDE VENEERED IN CANALETTO WALNUT AND OUTSIDE IN TANGANICA WALNUT TH. 2.9 CM - WITH MULTILAYER SLAT VENEERED IN CANALETTO WALNUT AND SIDES IN SOLID CANALETTO WOOD TH 0.3 CM
<b>GLASS DOORS:</b>	TEMPREDE GLASS TH. 0.6 CM - INTERNAL GLASS SHELVES
<b>SUPPORT PANELS:</b>	FJ WOOD COVERED IN CANALETTO WALNUT 60/70X25 SECTION
<b>BACK FEET:</b>	SOLID CANALETTO WALNUT
<b>BACK PANELS:</b>	BACK PANEL INSIDE WOODEN DOOR IN MULTILAYER TANGANICA WALNUT BACK PANEL INSIDE GLASS DOORS IN MULTILAYER CANALETTO WALNUT
<b>OPENING:</b>	DOMINO HANDLE IN METAL PAINTED ZAMAK

### VETRINA 2 ANTE VETRO

<b>STRUTTURA:</b>	PANNELLO DI LISTELLARE RIVESTITO IN NOCE CANALETTO
<b>TOP:</b>	PANNELLO DI LISTELLARE IMPIALLACCIATO NOCE CANALETTO E STRUTTURA PERIMETRALE IN MASSELLO DI NOCE CANALETTO SP. 1.8
<b>ANTE VETRO:</b>	VETRO TEMPERATO S.P 0.6 CM - RIPIANI INTERNI VETRO
<b>SPALLE:</b>	LEGNO FJ RIVESTITO NOCE CANALETTO SEZIONE 60/70X25
<b>PIEDI POSTERIORI:</b>	MASSELLO DI NOCE CANALETTO
<b>SCHIENALI:</b>	SCHIENALE IN MULTISTRATI DI NOCE CANALETTO
<b>APERTURA:</b>	MANIGLIA DOMINO SU DISEGNO IN ZAMA VERNICIATO METALLO

### DISPLAY UNIT WITH 2 GLASS DOORS

<b>STRUCTURE:</b>	BLOCKBOARD PANEL COVERED IN CANALETTO WALNUT
<b>TOP:</b>	BLOCKBOARD PANEL VENEERED IN CANALETTO WALNUT AND PERIMETRIC STRUCTURE IN SOLID CANALETTO WALNUT, TH. 1.8
<b>GLASS DOORS:</b>	TEMPREDE GLASS TH. 0.6 CM - INTERNAL GLASS SHELVES
<b>SUPPORT PANELS:</b>	FJ WOOD COVERED IN CANALETTO WALNUT 60/70X25 SECTION
<b>BACK FEET:</b>	SOLID CANALETTO WALNUT
<b>BACK PANELS:</b>	BACK PANEL IN MULTILAYER CANALETTO WALNUT
<b>OPENING:</b>	DOMINO HANDLE IN METAL PAINTED ZAMAK

DOMINO

CARATTERISTICHE TECNICHE  
TECHNICAL CHARACTERISTICS

SEDIE  
CHAIRS

SHANGHAI

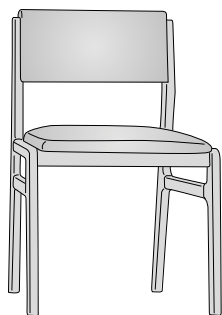

SENZA BRACCIOLO  
WITHOUT ARMREST

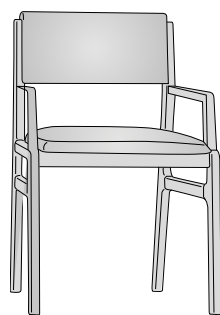

CON BRACCIOLO  
WITH ARMREST

**SEDIA SHANGHAI**

**FUSTO:** MASSELLO DI NOCE CANALETTO VERNICIATO

**SEDUTA:** PANNELLO IN MULTISTRATI PIOPPO IMBOTTITO IN GOMMAPIUMA E RIVESTITO CON TESSUTI DA CAMPIONARIO

**DOMINO CHAIR**

**CARCASE:** SOLID VARNISHED CANALETTO WALNUT

**SEAT:** POPLAR MULTILAYER PANEL UPHOLSTERED IN FOAM RUBBER AND COVERED WITH SAMPLE FABRICS

DOMINO

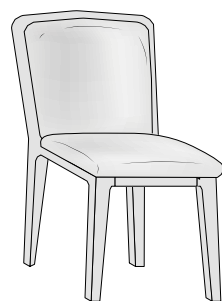

**SEDIA DOMINO**

**FUSTO:** MASSELLO DI NOCE CANALETTO

**SEDUTA:** PANNELLO IN MULTISTRATI PIOPPO IMBOTTITO IN GOMMAPIUMA E RIVESTITO CON TESSUTI DA CAMPIONARIO

**DOMINO CHAIR**

**CARCASE:** SOLID CANALETTO WALNUT

**SEAT:** POPLAR MULTILAYER PANEL UPHOLSTERED IN FOAM RUBBER AND COVERED WITH SAMPLE FABRICS

BARCELONA



**SEDIA BARCELONA**

**FUSTO:** MASSELLO DI FAGGIO

**SEDUTA:** PANNELLO IN MULTISTRATI PIOPPO IMBOTTITO IN GOMMAPIUMA E RIVESTITO CON TESSUTI DA CAMPIONARIO

**BARCELONA CHAIR**

**CARCASE:** SOLID BEECH

**SEAT:** POPLAR MULTILAYER PANEL UPHOLSTERED IN FOAM RUBBER AND COVERED WITH SAMPLE FABRICS

### TAVOLO SHANGHAI SHANGHAI TABLE

SHANGHAI

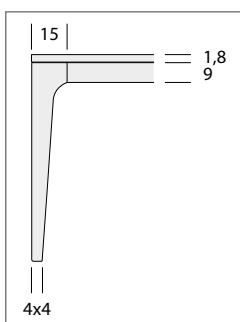
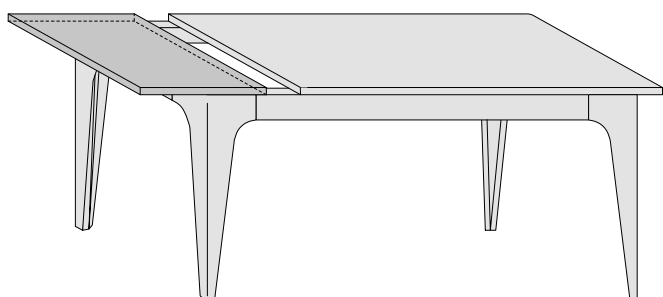

PROFILO TAVOLO LEGNO  
TABLE WOODEN PROFILE

#### TAVOLO LEGNO ALLUNGABILE

**TOP:** PANNELLO DI LISTELLARE RIVESTITO NOCE CANALETTO BORDATO SP. 2.5

**ALLUNGHE:** PANNELLO DI LISTELLARE RIVESTITO NOCE CANALETTO BORDATO SP. 2.5

**GAMBE:** PANNELLO DI LISTELLARE RIVESTITO NOCE CANALETTO E STRUTTURA PERIMETRALE IN MASSELLO DI NOCE CANALETTO

**MISURE DISPONIBILI:** 115 X 115 CM CON ALLUNGA DA 55 CM  
160 X 90 CM E 180 X 100 CON ALLUNGA DA 60 CM

**OPTIONAL PIANI:** VETRO EFFETTO MARMO (SAHARA NOIRE, KALACATTA) SP. 3 MM

#### EXTENDABLE WOODEN TABLE

**TOP:** STRIP PANEL COATED AND EDGED IN CANALETTO WALNUT SP. CM 2,5

**EXTENSIONS:** STRIP PANEL COATED AND EDGED IN CANALETTO WALNUT SP. CM 2,5

**LEGS:** BLOCKBOARD PANEL COVERED IN CANALETTO WALNUT AND PERIMETRIC STRUCTURE IN SOLID CANALETTO WALNUT

**AVAILABLE DIM.:** 115 X 115 CM WITH 1 EXTENSION OF 55 CM  
160 X 90 CM E 180 X 100 WITH 1 EXTENSION OF 60 CM

**TOP OPTIONAL:** GLASS MARBLE EFFECT (SAHARA NOIRE, KALACATTA) TH. 3 MM

### TAVOLO DOMINO DOMINO TABLE

DOMINO

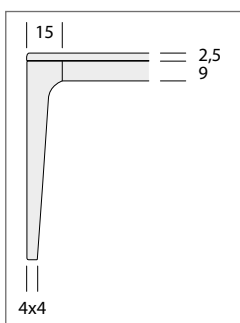
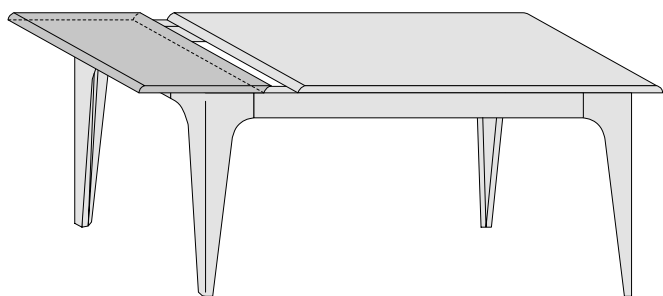

PROFILO TAVOLO LEGNO  
TABLE WOODEN PROFILE

#### TAVOLO LEGNO ALLUNGABILE

**TOP:** PANNELLO DI LISTELLARE RIVESTITO NOCE CANALETTO E STRUTTURA PERIMETRALE IN MASSELLO DI NOCE CANALETTO SP. 2.5

**ALLUNGHE:** PANNELLO DI LISTELLARE RIVESTITO NOCE CANALETTO E STRUTTURA PERIMETRALE IN MASSELLO DI NOCE CANALETTO SP. 2.5

**GAMBE:** PANNELLO DI LISTELLARE RIVESTITO NOCE CANALETTO E STRUTTURA PERIMETRALE IN MASSELLO DI NOCE CANALETTO

**MISURE DISPONIBILI:** 115 X 115 CM CON ALLUNGA DA 55 CM  
160 X 90 CM E 180 X 100 CON ALLUNGA DA 60 CM

**OPTIONAL PIANI:** MARMO SP. 20 MM

#### EXTENDABLE WOODEN TABLE

**TOP:** BLOCKBOARD PANEL COVERED IN CANALETTO WALNUT AND PERIMETRIC STRUCTURE IN SOLID CANALETTO WALNUT TH. 2.5

**EXTENSIONS:** BLOCKBOARD PANEL COVERED IN CANALETTO WALNUT AND PERIMETRIC STRUCTURE IN SOLID CANALETTO WALNUT TH. 2.5

**LEGS:** BLOCKBOARD PANEL COVERED IN CANALETTO WALNUT AND PERIMETRIC STRUCTURE IN SOLID CANALETTO WALNUT

**AVAILABLE DIM.:** 115 X 115 CM WITH 1 EXTENSION OF 55 CM  
160 X 90 CM E 180 X 100 WITH 1 EXTENSION OF 60 CM

**TOP OPTIONAL:** MARBLE TH. 20 MM

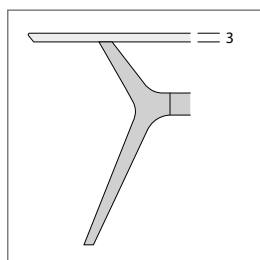
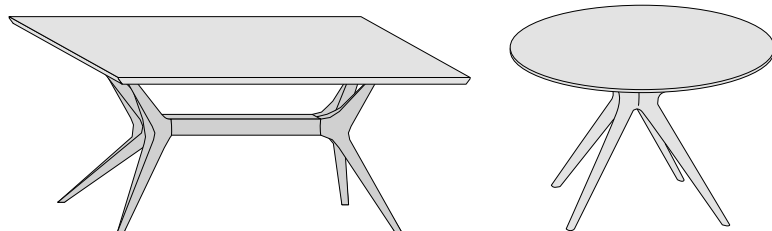

**TAVOLO FOSTER**  
**FOSTER TABLE**
**PIANO IN LEGNO**  
 WOODEN TOP

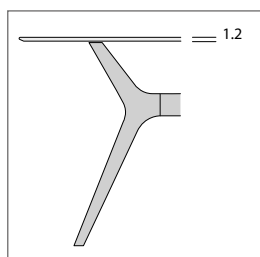
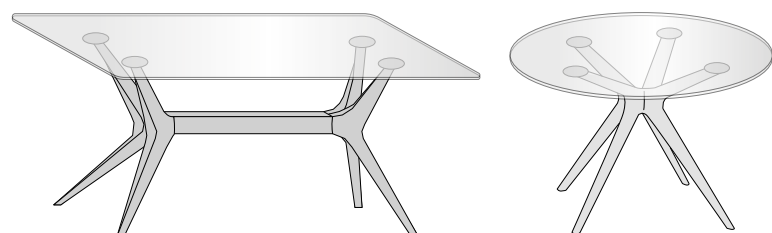
**PROFILO PIANO LEGNO**  
 WOODEN TOP PROFILE

**PIANO IN CRISTALLO**  
 GLASS TOP

**PROFILO PIANO VETRO**  
 GLASS TOP PROFILE

**TAVOLO LEGNO**

**TOP:** PANNELLO DI LISTELLARE RIVESTITO NOCE CANALETTO E STRUTTURA PERIMETRALE IN MASSELLO DI NOCE CANALETTO SP. 3

**ALLUNGHE:** (OPTIONAL) PER TAVOLO RETTANGOLARE: N.2 ALLUNGHE DA 45 CON GUIDE IN LEGNO IN PANNELLO DI LISTELLARE RIVESTITO NOCE CANALETTO E STRUTTURA PERIMETRALE IN MASSELLO DI NOCE CANALETTO SP. 3

**GAMBE:** MASSELLO DI FAGGIO O MASSELLO DI NOCE CANALETTO

**MISURE DISPONIBILI:** TAVOLO RETTANGOLARE: 180 X 100 CM. - 200 X 100 CM.  
TAVOLO ROTONDO: Ø 130, 140, 150, 160 CM.

**WOODEN TABLE**

**TOP:** BLOCKBOARD PANEL COVERED IN CANALETTO WALNUT AND PERIMETRIC STRUCTURE IN SOLID CANALETTO WALNUT TH. 3

**EXTENSIONS:** (OPTIONAL) FOR RECTANGULAR TABLE: 2X45 CM WIDE EXTENSIONS WITH WOODEN GUIDES, IN BLOCKBOARD PANEL COVERED IN CANALETTO WALNUT AND PERIMETRIC STRUCTURE IN SOLID CANALETTO WALNUT TH. 3

**LEGS:** SOLID BEECH OR CANALETTO WALNUT

**AVAILABLE DIM.:** RECTANGULAR TABLE: 180 X 100 CM. - 200 X 100 CM.  
ROUND TABLE: Ø 130, 140, 150, 160 CM.

**TAVOLO VETRO**

**TOP:** VETRO EXTRA CHIARO TEMPERATO SP. 1.2  
CON PIASTRE IN ACCIAIO VERNICIATO

**GAMBE:** MASSELLO DI FAGGIO O MASSELLO DI NOCE CANALETTO E CON PIASTRE IN METALLO VERNICIATO

**MISURE DISPONIBILI:** TAVOLO RETTANGOLARE: 180 X 100 CM. - 200 X 100 CM.  
TAVOLO ROTONDO: Ø 130, 140, 150, 160 CM.

**VARIANTE DISPONIBILE:** VETRO FUMÉ

**GLASS TABLE**

**TOP:** TEMPERED EXTRA-CLEAR GLASS TH. 1.2  
WITH PAINTED STEEL PLATES

**LEGS:** SOLID BEECH OR CANALETTO WALNUT  
AND WITH PAINTED STEEL PLATES

**AVAILABLE DIM.:** RECTANGULAR TABLE: 180 X 100 CM. - 200 X 100 CM.  
ROUND TABLE: Ø 130, 140, 150, 160 CM.

**VARIANT AVAILABLE:** SMOKED GLASS

FOSTER

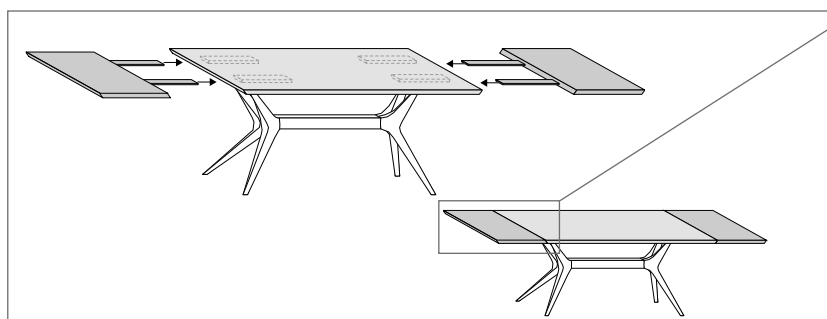

OPTIONAL: KIT 2 ALLUNGHE DA 45 DA ALLOGGIARE ESTERNAMENTE AL TAVOLO (FORNITE IN APPOSITA BORSA IN TESSUTO IN DOTAZIONE)

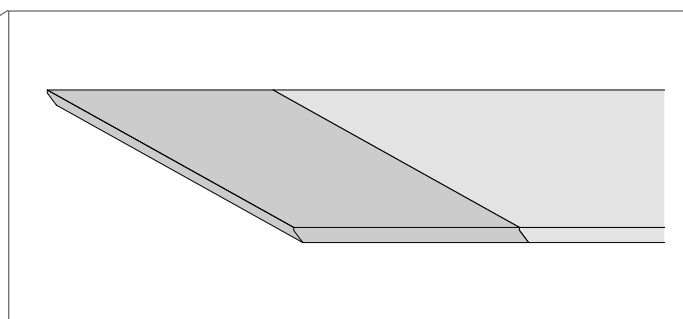

### TAVOLO NORMAN NORMAN TABLE

PIANO VETRO EFFETTO MARMO  
GLASS TOP WITH MARBLE EFFECT

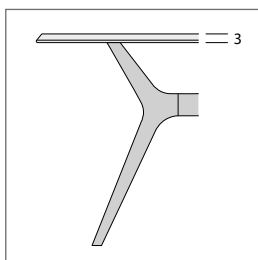
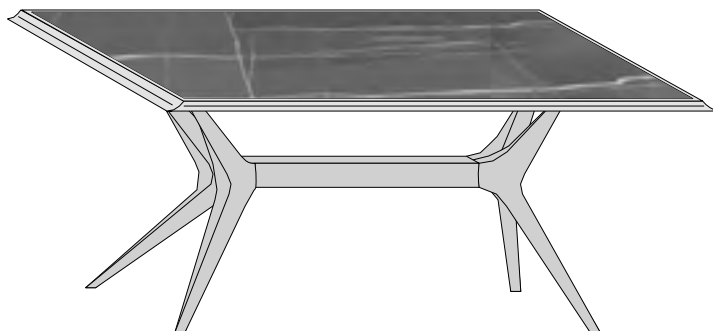

PROFILO PIANO  
TOP PROFILE

### TAVOLO LEGNO PIANO SAHARA NOIRE O KALACATTA

**TOP:** PANNELLO DI LISTELLARE RIVESTITO NOCE CANALETTO SCAVATO E STRUTTURA PERIMETRALE IN MASSELLO DI NOCE CANALETTO SP. 3. INSERTO IN VETRO OPACO STAMPATO EFFETTO MARMO.

**GAMBE:** MASSELLO DI FAGGIO O MASSELLO DI NOCE CANALETTO  
NON SONO PREVISTE ALLUNGHE

**MISURE DISPONIBILI:** TAVOLO RETTANGOLARE: 180 X 100 CM. - 200 X 100 CM.

### WOODEN TABLE WITH SAHARA NOIRE OR KALACATTA TOP

**TOP:** STRIP PANEL COVERED IN CANALETTO WALNUT AND STRUCTURE PERIMETER IN SOLID CANALETTO WALNUT SP. 3. INSERT IN PRINTED MATT GLASS MARBLE EFFECT.

**LEGS:** SOLID BEECH OR SOLID CANALETTO WALNUT

**AVAILABLE DIM.:** RECTANGULAR TABLE: 180 X 100 CM. - 200 X 100 CM.

**TAVOLINI**  
**SMALL TABLES**

SHANGHAI

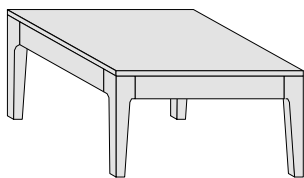
**TAVOLINO QUADRATO**  
 SQUARE TABLE

80 X 80 H. 40 CM.

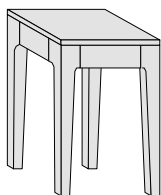
**TAVOLINO QUADRATO ALTO**  
 HIGH SQUARE TABLE

38 X 38 H. 60 CM.

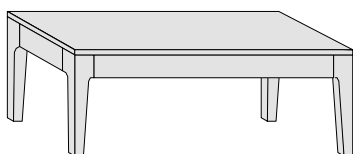
**TAVOLINO RETTANGOLARE**  
 RECTANGULAR TABLE

120 X 50 H. 40 CM.

**TAVOLINO QUADRATO E RETTANGOLARE**
**TOP:** PANNELLO DI LISTELLARE RIVESTITO E BORDATO NOCE CANALETTO SP.1.8

**COLLETO:** PANNELLO DI LISTELLARE IMPIALLACCIATO IN NOCE CANALETTO

**GAMBE:** MASSELLO DI NOCE CANALETTO

**OPTIONAL PIANI:** VETRO EFFETTO MARMO (SAHARA NOIRE O KALACATTA) SP. 3 MM

**SQUARE AND RECTANGULAR TABLE**
**TOP:** BLOCKBOARD PANEL COVERED IN CANALETTO WALNUT TH.1.8

**BAND:** BLOCKBOARD PANEL VENEERED IN CANALETTO WALNUT

**LEGS:** SOLID CANALETTO WALNUT

**TOP OPTIONAL:** GLASS MARBLE EFFECT (SAHARA NOIRE OR KALACATTA) TH. 3 MM

DOMINO

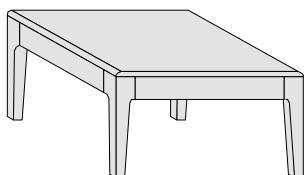
**TAVOLINO QUADRATO**  
 SQUARE TABLE

80 X 80 H. 40 CM.

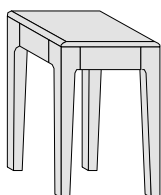
**TAVOLINO QUADRATO ALTO**  
 HIGH SQUARE TABLE

38 X 38 H. 60 CM.

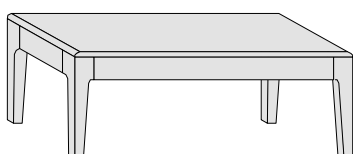
**TAVOLINO RETTANGOLARE**  
 RECTANGULAR TABLE

120 X 50 H. 40 CM.

**TAVOLINO QUADRATO E RETTANGOLARE**
**TOP:** PANNELLO DI LISTELLARE RIVESTITO NOCE CANALETTO E STRUTTURA PERIMETRALE IN MASSELLO DI NOCE CANALETTO SP.1.8

**COLLETO:** PANNELLO DI LISTELLARE IMPIALLACCIATO IN NOCE CANALETTO

**GAMBE:** MASSELLO DI NOCE CANALETTO

**OPTIONAL PIANI:** MARMO SP. 20 MM

**SQUARE AND RECTANGULAR TABLE**
**TOP:** BLOCKBOARD PANEL COVERED IN CANALETTO WALNUT AND PERIMETRIC STRUCTURE IN SOLID CANALETTO WALNUT TH.1.8

**BAND:** BLOCKBOARD PANEL VENEERED IN CANALETTO WALNUT

**LEGS:** SOLID CANALETTO WALNUT

**TOP OPTIONAL:** MARBLE TH. 20 MM

## LETTI BEDS

### LETTO BUTTERFLY TESTIERA IMBOTTITA BUTTERFLY BED UPHOLSTERED PANEL

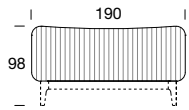

L.160

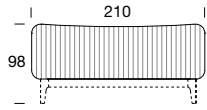

L.180

LETTO DA 160 – GIROLETTO LEGNO  
160 CM WIDE BED – WOODEN BED SURROUND



212

MISURE INTERNE 162X202 PER MATERASSO 160X200  
INTERNAL DIMENSIONS 162X202 FOR MATTRESS 160X200

DON5701K		
CAT. A	CAT. B	CAT. C
ECOPELLE/ECONABUK ECOLEATHER/ECONABUK	LINO/VELLUTO LINEN/VELVET	PELLE LEATHER
<b>2.830</b>	<b>2.950</b>	<b>2.989</b>

mc 0,23 – Kg 65

LETTO DA 160 – GIROLETTO LEGNO CON FASCIA IMBOTTITA  
160 CM WIDE BED – WOODEN AND UPHOLSTERED BED SURROUND



212

MISURE INTERNE 162X202 PER MATERASSO 160X200  
INTERNAL DIMENSIONS 162X202 FOR MATTRESS 160X200

DON5721K		
CAT. A	CAT. B	CAT. C
ECOPELLE/ECONABUK ECOLEATHER/ECONABUK	LINO/VELLUTO LINEN/VELVET	PELLE LEATHER
<b>3.263</b>	<b>3.424</b>	<b>3.578</b>

mc 0,23 – Kg 65

LETTO DA 160 GIROLETTO IMBOTTITO  
(CONTENITORE CON RETE BASCULANTE OPTIONAL)  
160 CM WIDE BED WITH UPHOLSTERED BED SURROUND  
(OPTIONAL BED STORAGE WITH TILTING BED BASE)



220

SPAZIO UTILE CONTENITORE H. CM 16 – MISURE INTERNE 162X204  
STORAGE USEFUL SPACE H. CM 16 – INTERNAL DIMENSIONS 162X204

DON5731K			OPTIONAL
CAT. A	CAT. B	CAT. C	
ECOPELLE/ECONABUK ECOLEATHER/ECONABUK	LINO/VELLUTO LINEN/VELVET	PELLE LEATHER	BOX CONTENITORE STORAGE BED
<b>4.468</b>	<b>4.129</b>	<b>4.516</b>	<b>+ 680</b>

mc 0,31 – Kg 85

mc 0,40 – Kg 66

CANALETTO

### LETTI ALBA TESTIERA IMBOTTITA ALBA BEDS UPHOLSTERED PANEL

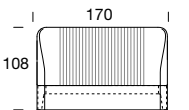

L.160

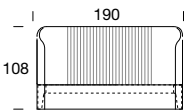

L.180

LETTO DA 160 – GIROLETTO LEGNO  
160 CM WIDE BED – WOODEN BED SURROUND

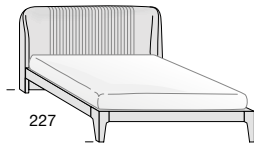

227

MISURE INTERNE 162X202 PER MATERASSO 160X200  
INTERNAL DIMENSIONS 162X202 FOR MATTRESS 160X200

SHN5301K		
CAT. A	CAT. B	CAT. C
ECOPELLE/ECONABUK ECOLEATHER/ECONABUK	LINO/VELLUTO LINEN/VELVET	PELLE LEATHER
<b>3.375</b>	<b>3.529</b>	<b>4.910</b>

mc 0,90 – Kg 75

LETTO DA 160 – GIROLETTO LEGNO CON FASCIA IMBOTTITA  
160 CM WIDE BED – WOODEN AND UPHOLSTERED BED SURROUND

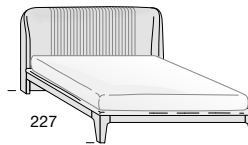

227

MISURE INTERNE 162X202 PER MATERASSO 160X200  
INTERNAL DIMENSIONS 162X202 FOR MATTRESS 160X200

SHN5101K		
CAT. A	CAT. B	CAT. C
ECOPELLE/ECONABUK ECOLEATHER/ECONABUK	LINO/VELLUTO LINEN/VELVET	PELLE LEATHER
<b>3.770</b>	<b>3.985</b>	<b>5.455</b>

mc 0,90 – Kg 75

LETTO DA 160 GIROLETTO IMBOTTITO  
(CONTENITORE CON RETE BASCULANTE OPTIONAL)  
160 CM WIDE BED WITH UPHOLSTERED BED SURROUND  
(OPTIONAL BED STORAGE WITH TILTING BED BASE)

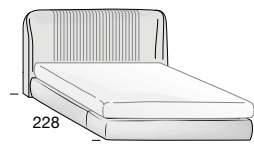

228

SPAZIO UTILE CONTENITORE H. CM 16 – MISURE INTERNE 162X202  
STORAGE USEFUL SPACE H. CM 16 – INTERNAL DIMENSIONS 162X202

SHN5701K			OPTIONAL
CAT. A	CAT. B	CAT. C	
ECOPELLE/ECONABUK ECOLEATHER/ECONABUK	LINO/VELLUTO LINEN/VELVET	PELLE LEATHER	BOX CONTENITORE STORAGE BED
<b>4.266</b>	<b>4.440</b>	<b>5.701</b>	<b>+ 680</b>

mc 1,15 – Kg 95

mc 0,40 – Kg 66

CANALETTO

### LETTO PEDRERA TESTIERA TRAFORATA PEDRERA BED PERFORATED PANEL

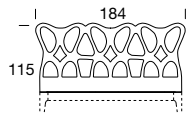

L.160

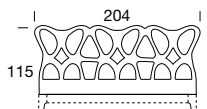

L.180

LETTO DA 160 – GIROLETTO LEGNO  
160 CM WIDE BED – WOODEN BED SURROUND



209

MISURE INTERNE 162X202 PER MATERASSO 160X200  
INTERNAL DIMENSIONS 162X202 FOR MATTRESS 160X200

DON5211K		
CAT. A	CAT. B	CAT. C
ECOPELLE/ECONABUK ECOLEATHER/ECONABUK	LINO/VELLUTO LINEN/VELVET	PELLE LEATHER
<b>5.253</b>		

mc 0,17 – Kg 60

LETTO DA 160 – GIROLETTO LEGNO CON FASCIA IMBOTTITA  
160 CM WIDE BED – WOODEN AND UPHOLSTERED BED SURROUND



209

MISURE INTERNE 162X202 PER MATERASSO 160X200  
INTERNAL DIMENSIONS 162X202 FOR MATTRESS 160X200

DON5221K		
CAT. A	CAT. B	CAT. C
ECOPELLE/ECONABUK ECOLEATHER/ECONABUK	LINO/VELLUTO LINEN/VELVET	PELLE LEATHER
<b>5.487</b>	<b>5.543</b>	<b>5.709</b>

mc 0,17 – Kg 60

CANALETTO

### LETTO TOBIA TESTIERA IMBOTTITA TOBIA BED UPHOLSTERED PANEL

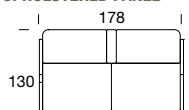

L.160

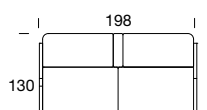

L.180

LETTO DA 160 – GIROLETTO LEGNO  
160 CM WIDE BED – WOODEN BED SURROUND

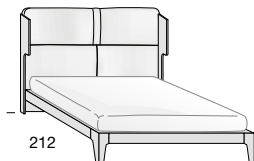

212

MISURE INTERNE 162X202 PER MATERASSO 160X200  
INTERNAL DIMENSIONS 162X202 FOR MATTRESS 160X200

DON5011K		
DON5011K	DON5011K	DON5011K
ECOPELLE/ECONABUK ECOLEATHER/ECONABUK	LINO/VELLUTO LINEN/VELVET	PELLE LEATHER
<b>3.350</b>	<b>3.430</b>	<b>3.960</b>

mc 0,23 – Kg 65

LETTO DA 160 – GIROLETTO LEGNO CON FASCIA IMBOTTITA  
160 CM WIDE BED – WOODEN AND UPHOLSTERED BED SURROUND

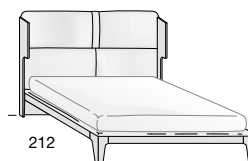

212

MISURE INTERNE 162X202 PER MATERASSO 160X200  
INTERNAL DIMENSIONS 162X202 FOR MATTRESS 160X200

DON5021K		
DON5021K	DON5021K	DON5021K
ECOPELLE/ECONABUK ECOLEATHER/ECONABUK	LINO/VELLUTO LINEN/VELVET	PELLE LEATHER
<b>3.782</b>	<b>3.930</b>	<b>4.573</b>

mc 0,23 – Kg 65

LETTO DA 160 GIROLETTO IMBOTTITO  
(CONTENITORE CON RETE BASCULANTE OPTIONAL)  
160 CM WIDE BED WITH UPHOLSTERED BED SURROUND  
(OPTIONAL BED STORAGE WITH TILTING BED BASE)



220

SPAZIO UTILE CONTENITORE H. CM 16 – MISURE INTERNE 162X204  
STORAGE USEFUL SPACE H. CM 16 – INTERNAL DIMENSIONS 162X204

DON5031K			OPTIONAL
CAT. A	CAT. B	CAT. C	
ECOPELLE/ECONABUK ECOLEATHER/ECONABUK	LINO/VELLUTO LINEN/VELVET	PELLE LEATHER	BOX CONTENITORE STORAGE BED
<b>4.216</b>	<b>4.426</b>	<b>5.297</b>	<b>+ 680</b>

mc 0,31 – Kg 85

mc 0,40 – Kg 66

CANALETTO

**LETTO DA 180 – GIROLETTO LEGNO**  
180 CM WIDE BED – WOODEN BED SURROUND



MISURE INTERNE 182x202 PER MATERASSO 180X200  
INTERNAL DIMENSIONS 182X202 FOR MATTRESS 180X200

DON5741K		
CAT. A	CAT. B	CAT. C
ECOPELLE/ECONABUK ECOLEATHER/ECONABUK	LINO/VELLUTO LINEN/VELVET	PELLE LEATHER
<b>3.103</b>	<b>3.219</b>	<b>3.236</b>
mc 0,26 – Kg 70		

**LETTO DA 180 – GIROLETTO LEGNO CON FASCIA IMBOTTITA**  
180 CM WIDE BED – WOODEN AND UPHOLSTERED BED SURROUND



MISURE INTERNE 182x202 PER MATERASSO 180X200  
INTERNAL DIMENSIONS 182X202 FOR MATTRESS 180X200

DON5751K		
CAT. A	CAT. B	CAT. C
ECOPELLE/ECONABUK ECOLEATHER/ECONABUK	LINO/VELLUTO LINEN/VELVET	PELLE LEATHER
<b>3.541</b>	<b>3.702</b>	<b>3.832</b>
mc 0,26 – Kg 70		

**LETTO DA 180 GIROLETTO IMBOTTITO**  
(CONTENITORE CON RETE BASCULANTE OPTIONAL)  
180 CM WIDE BED WITH UPHOLSTERED BED SURROUND  
(OPTIONAL BED STORAGE WITH TILTING BED BASE)



SPAZIO UTILE CONTENITORE H. CM 16 – MISURE INTERNE 182X202  
STORAGE USEFUL SPACE H. CM 16 – INTERNAL DIMENSIONS 182X202

DON5761K			OPTIONAL
CAT. A	CAT. B	CAT. C	
ECOPELLE/ECONABUK ECOLEATHER/ECONABUK	LINO/VELLUTO LINEN/VELVET	PELLE LEATHER	BOX CONTENITORE STORAGE BED
<b>4.031</b>	<b>4.346</b>	<b>4.693</b>	<b>+ 750</b>
mc 0,35 – Kg 100			mc 0,40 – Kg 66

**LETTO DA 180 – GIROLETTO LEGNO**  
180 CM WIDE BED – WOODEN BED SURROUND

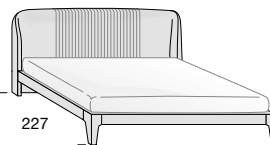

MISURE INTERNE 182x202 PER MATERASSO 180X200  
INTERNAL DIMENSIONS 182X202 FOR MATTRESS 180X200

SHN5302K		
CAT. A	CAT. B	CAT. C
ECOPELLE/ECONABUK ECOLEATHER/ECONABUK	LINO/VELLUTO LINEN/VELVET	PELLE LEATHER
<b>3.639</b>	<b>3.801</b>	<b>5.146</b>
mc 0,95 – Kg 80		

**LETTO DA 180 – GIROLETTO LEGNO CON FASCIA IMBOTTITA**  
180 CM WIDE BED – WOODEN AND UPHOLSTERED BED SURROUND

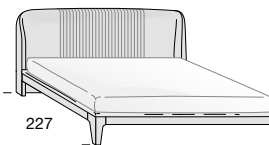

MISURE INTERNE 182x202 PER MATERASSO 180X200  
INTERNAL DIMENSIONS 182X202 FOR MATTRESS 180X200

SHN5102K		
CAT. A	CAT. B	CAT. C
ECOPELLE/ECONABUK ECOLEATHER/ECONABUK	LINO/VELLUTO LINEN/VELVET	PELLE LEATHER
<b>4.041</b>	<b>4.257</b>	<b>5.697</b>
mc 0,95 – Kg 80		

**LETTO DA 180 GIROLETTO IMBOTTITO**  
(CONTENITORE CON RETE BASCULANTE OPTIONAL)  
180 CM WIDE BED WITH UPHOLSTERED BED SURROUND  
(OPTIONAL BED STORAGE WITH TILTING BED BASE)

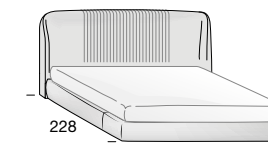

SPAZIO UTILE CONTENITORE H. CM 16 – MISURE INTERNE 182X202  
STORAGE USEFUL SPACE H. CM 16 – INTERNAL DIMENSIONS 182X202

SHN5702K			OPTIONAL
CAT. A	CAT. B	CAT. C	
ECOPELLE/ECONABUK ECOLEATHER/ECONABUK	LINO/VELLUTO LINEN/VELVET	PELLE LEATHER	BOX CONTENITORE STORAGE BED
<b>4.483</b>	<b>4.649</b>	<b>5.879</b>	<b>+ 750</b>
mc 1,40 – Kg 105			mc 0,40 – Kg 66

**LETTO DA 180 – GIROLETTO LEGNO**  
180 CM WIDE BED – WOODEN BED SURROUND



MISURE INTERNE 182x202 PER MATERASSO 180X200  
INTERNAL DIMENSIONS 182X202 FOR MATTRESS 180X200

DON5231K		
CAT. A	CAT. B	CAT. C
ECOPELLE/ECONABUK ECOLEATHER/ECONABUK	LINO/VELLUTO LINEN/VELVET	PELLE LEATHER
<b>5.500</b>		
mc 0,19 – Kg 65		

**LETTO DA 180 – GIROLETTO LEGNO CON FASCIA IMBOTTITA**  
180 CM WIDE BED – WOODEN AND UPHOLSTERED BED SURROUND



MISURE INTERNE 182x202 PER MATERASSO 180X200  
INTERNAL DIMENSIONS 182X202 FOR MATTRESS 180X200

DON5241K		
CAT. A	CAT. B	CAT. C
ECOPELLE/ECONABUK ECOLEATHER/ECONABUK	LINO/VELLUTO LINEN/VELVET	PELLE LEATHER
<b>5.765</b>	<b>5.828</b>	<b>6.003</b>
mc 0,19 – Kg 65		

**LETTO DA 180 – GIROLETTO LEGNO**  
180 CM WIDE BED – WOODEN BED SURROUND

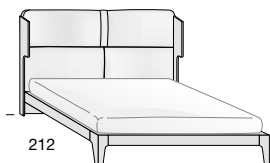

MISURE INTERNE 182x202 PER MATERASSO 180X200  
INTERNAL DIMENSIONS 182X202 FOR MATTRESS 180X200

DON5041K		
CAT. A	CAT. B	CAT. C
ECOPELLE/ECONABUK ECOLEATHER/ECONABUK	LINO/VELLUTO LINEN/VELVET	PELLE LEATHER
<b>3.639</b>	<b>3.714</b>	<b>4.354</b>
mc 0,26 – Kg 70		

**LETTO DA 180 – GIROLETTO LEGNO CON FASCIA IMBOTTITA**  
180 CM WIDE BED – WOODEN AND UPHOLSTERED BED SURROUND

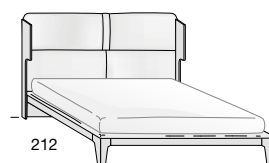

MISURE INTERNE 182x202 PER MATERASSO 180X200  
INTERNAL DIMENSIONS 182X202 FOR MATTRESS 180X200

DON5051K		
CAT. A	CAT. B	CAT. C
ECOPELLE/ECONABUK ECOLEATHER/ECONABUK	LINO/VELLUTO LINEN/VELVET	PELLE LEATHER
<b>4.067</b>	<b>4.215</b>	<b>4.971</b>
mc 0,26 – Kg 70		

**LETTO DA 180 GIROLETTO IMBOTTITO**  
(CONTENITORE CON RETE BASCULANTE OPTIONAL)  
180 CM WIDE BED WITH UPHOLSTERED BED SURROUND  
(OPTIONAL BED STORAGE WITH TILTING BED BASE)



SPAZIO UTILE CONTENITORE H. CM 16 – MISURE INTERNE 182X204  
STORAGE USEFUL SPACE H. CM 16 – INTERNAL DIMENSIONS 182X204

DON5061K			OPTIONAL
CAT. A	CAT. B	CAT. C	
ECOPELLE/ECONABUK ECOLEATHER/ECONABUK	LINO/VELLUTO LINEN/VELVET	PELLE LEATHER	BOX CONTENITORE STORAGE BED
<b>4.458</b>	<b>4.656</b>	<b>5.626</b>	<b>+ 750</b>
mc 0,35 – Kg 100			mc 0,40 – Kg 66

#### MAGGIORAZIONI E RIDUZIONI SURCHARGES AND REDUCTIONS

PER LONGHERONI PIÙ LUNGI  
O PIÙ CORTI APPLICARE  
MAGG. DEL  
FOR LONGER OR SHORTER  
SIDES PLEASE ADD THE  
FOLLOWING EXTRA CHARGE

**+ 10%**



SOLLEVAMENTO  
ORIZZONTALE  
HORIZONTAL LIFTING  
MECHANISM

**+ 222**

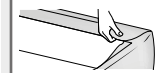

**+ 525**

GIROLETTO CONTENITORE IMBOTTITO  
SFODERABILE  
UPHOLSTERED STORAGE BED  
SURROUND WITH REMOVABLE COVER

#### RETE A DOGHE SLATTED BED BASE

RETE 160x200  
PER LETTI DA 160  
BED BASE 160x200  
FOR 160 CM WIDE BEDS

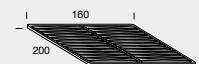

#### ACS5160K

**433**

RETE 180x200  
PER LETTI DA 180  
BED BASE 180x200  
FOR 180 CM WIDE BEDS



#### ACS5180K

**593**

KIT SUPPORTI PER RETI  
SINGOLE O RETI MOTORIZZATE  
KIT WITH SUPPORTS FOR SINGLE  
OR MOTORIZED BED BASE UNIT  
WITHS

#### ACS5191K

**235**

# NOTTE - NIGHT

## LETTI BEDS

### LETTO DOMINO TESTIERA LEGNO A DOGHE DOMINO BED SLATTED WOODEN HEADBOARD

NEW

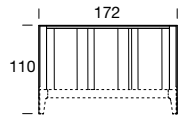

L.160

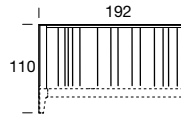

L.180

CANALETTO	2.626
Doghe Multicolor / Multicolor slats	+ 5 %
Doga righe / Ribbed slats	+ 55
	mc 0,25 – Kg 65

LETTO DA 160 – GIROLETTO LEGNO  
160 CM WIDE BED – WOODEN BED SURROUND



210

MISURE INTERNE 162X202 PER MATERASSO 160X200  
INTERNAL DIMENSIONS 162X202 FOR MATTRESS 160X200

DON5611K		
CAT. A	CAT. B	CAT. C
ECOPELLE/ECONABUK ECOLEATHER/ECONABUK	LINO/VELLUTO LINEN/VELVET	PELLE LEATHER
3.028	3.189	3.450
+ 5 %		
+ 55		
mc 0,25 – Kg 65		

LETTO DA 160 – GIROLETTO LEGNO CON FASCIA IMBOTTITA  
160 CM WIDE BED – WOODEN AND UPHOLSTERED BED SURROUND



210

MISURE INTERNE 162X202 PER MATERASSO 160X200  
INTERNAL DIMENSIONS 162X202 FOR MATTRESS 160X200

DON5621K		
CAT. A	CAT. B	CAT. C
ECOPELLE/ECONABUK ECOLEATHER/ECONABUK	LINO/VELLUTO LINEN/VELVET	PELLE LEATHER
3.028	3.189	3.450
+ 5 %		
+ 55		
mc 0,25 – Kg 65		

LETTO DA 160 GIROLETTO IMBOTTITO  
(CONTENITORE CON RETE BASCULANTE OPTIONAL)  
160 CM WIDE BED WITH UPHOLSTERED BED SURROUND  
(OPTIONAL BED STORAGE WITH TILTING BED BASE)

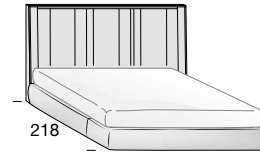

218

SPAZIO UTILE CONTENITORE H. CM 16 – MISURE INTERNE 162X204  
STORAGE USEFUL SPACE H. CM 16 – INTERNAL DIMENSIONS 162X204

DON5631K			OPTIONAL
CAT. A	CAT. B	CAT. C	
ECOPELLE/ECONABUK ECOLEATHER/ECONABUK	LINO/VELLUTO LINEN/VELVET	PELLE LEATHER	BOX CONTENITORE STORAGE BED
3.376	3.586	4.061	+ 680
+ 5 %			
+ 55			mc 0,40 – Kg 66
mc 0,33 – Kg 85			

### LETTO DOMINO TESTIERA IMBOTTITA A DOGHE DOMINO BED SLATTED UPHOLSTERED HEADBOARD

#### DOGA LEGNO LISCIA PLAIN WOODEN SLAT

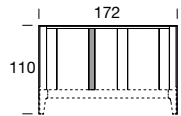

L.160

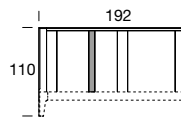

L.180

CANALETTO	2.781
Doghe Multicolor / Multicolor slats	+ 5 %
Doga righe / Ribbed slats	+ 55
Doga rivestita / Upholstered slat	+ 105
	mc 0,25 – Kg 65

LETTO DA 160 – GIROLETTO LEGNO  
160 CM WIDE BED – WOODEN BED SURROUND



210

MISURE INTERNE 162X202 PER MATERASSO 160X200  
INTERNAL DIMENSIONS 162X202 FOR MATTRESS 160X200

DON5506K		
CAT. A	CAT. B	CAT. C
ECOPELLE/ECONABUK ECOLEATHER/ECONABUK	LINO/VELLUTO LINEN/VELVET	PELLE LEATHER
2.781	2.880	3.016
+ 5 %		
+ 55		
mc 0,25 – Kg 65		

LETTO DA 160 – GIROLETTO LEGNO CON FASCIA IMBOTTITA  
160 CM WIDE BED – WOODEN AND UPHOLSTERED BED SURROUND



210

MISURE INTERNE 162X202 PER MATERASSO 160X200  
INTERNAL DIMENSIONS 162X202 FOR MATTRESS 160X200

DON5536K		
CAT. A	CAT. B	CAT. C
ECOPELLE/ECONABUK ECOLEATHER/ECONABUK	LINO/VELLUTO LINEN/VELVET	PELLE LEATHER
3.194	3.343	3.595
+ 5 %		
+ 55		
mc 0,25 – Kg 65		

LETTO DA 160 GIROLETTO IMBOTTITO  
(CONTENITORE E RETE BASCULANTE OPTIONAL)  
160 CM WIDE BED WITH UPHOLSTERED BED SURROUND  
(OPTIONAL BED STORAGE WITH TILTING BED BASE)



218

SPAZIO UTILE CONTENITORE H. CM 16 – MISURE INTERNE 162X204  
STORAGE USEFUL SPACE H. CM 16 – INTERNAL DIMENSIONS 162X204

DON5546K			OPTIONAL
CAT. A	CAT. B	CAT. C	????
ECOPELLE/ECONABUK ECOLEATHER/ECONABUK	LINO/VELLUTO LINEN/VELVET	PELLE LEATHER	BOX CONTENITORE STORAGE BED
3.542	3.747	4.213	+ 680
+ 5 %			
+ 55			mc 0,40 – Kg 66
mc 0,33 – Kg 85			

### LETTO SHANGHAI TESTIERA PAGLIA DI VIENNA E IMBOTTITA SHANGHAI BED 'VIENNA STRAW' HEADBOARD AND PADDED

NEW

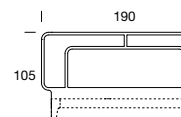

L.160

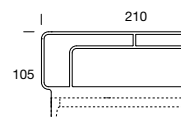

L.180

CANALETTO	3.139
	3.281
	3.758
	3.547
	3.727
	4.331
	3.863
	4.327
	4.837
	+ 680
	mc 0,25 – Kg 65

LETTO DA 160 – GIROLETTO LEGNO  
160 CM WIDE BED – WOODEN BED SURROUND



210

MISURE INTERNE 162X202 PER MATERASSO 160X200  
INTERNAL DIMENSIONS 162X202 FOR MATTRESS 160X200

DON5301K		
CAT. A	CAT. B	CAT. C
ECOPELLE/ECONABUK ECOLEATHER/ECONABUK	LINO/VELLUTO LINEN/VELVET	PELLE LEATHER
3.139	3.281	3.758
mc 0,25 – Kg 65		

LETTO DA 160 – GIROLETTO LEGNO CON FASCIA IMBOTTITA  
160 CM WIDE BED – WOODEN AND UPHOLSTERED BED SURROUND



210

MISURE INTERNE 162X202 PER MATERASSO 160X200  
INTERNAL DIMENSIONS 162X202 FOR MATTRESS 160X200

DON5311K		
CAT. A	CAT. B	CAT. C
ECOPELLE/ECONABUK ECOLEATHER/ECONABUK	LINO/VELLUTO LINEN/VELVET	PELLE LEATHER
3.547	3.727	4.331
mc 0,25 – Kg 65		

LETTO DA 160 GIROLETTO IMBOTTITO  
(CONTENITORE E RETE BASCULANTE OPTIONAL)  
160 CM WIDE BED WITH UPHOLSTERED BED SURROUND  
(OPTIONAL BED STORAGE WITH TILTING BED BASE)



218

SPAZIO UTILE CONTENITORE H. CM 16 – MISURE INTERNE 162X204  
STORAGE USEFUL SPACE H. CM 16 – INTERNAL DIMENSIONS 162X204

DON5321K			OPTIONAL
CAT. A	CAT. B	CAT. C	????
ECOPELLE/ECONABUK ECOLEATHER/ECONABUK	LINO/VELLUTO LINEN/VELVET	PELLE LEATHER	BOX CONTENITORE STORAGE BED
3.863	4.327	4.837	+ 680
mc 0,33 – Kg 85			mc 0,40 – Kg 66

LETTO DA 180 – GIROLETTO LEGNO  
180 CM WIDE BED – WOODEN BED SURROUND



LETTO DA 180 – GIROLETTO LEGNO CON FASCIA IMBOTTITA  
180 CM WIDE BED – WOODEN AND UPHOLSTERED BED SURROUND



LETTO DA 180 GIROLETTO IMBOTTITO  
(CONTENITORE CON RETE BASCULANTE OPTIONAL)  
180 CM WIDE BED WITH UPHOLSTERED BED SURROUND  
(OPTIONAL BED STORAGE WITH TILTING BED BASE)

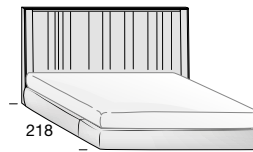

MISURE INTERNE 182X202 PER MATERASSO 180X200  
INTERNAL DIMENSIONS 182X202 FOR MATTRESS 180X200

DON5612K		
CAT. A	CAT. B	CAT. C
ECOPELLE/ECONABUK ECOLEATHER/ECONABUK	LINO/VELLUTO LINEN/VELVET	PELLE LEATHER
<b>2.892</b>		
<b>+ 5 %</b>		
<b>+ 55</b>		
mc 0,28 – Kg 75		

MISURE INTERNE 182X202 PER MATERASSO 180X200  
INTERNAL DIMENSIONS 182X202 FOR MATTRESS 180X200

DON5622K		
CAT. A	CAT. B	CAT. C
ECOPELLE/ECONABUK ECOLEATHER/ECONABUK	LINO/VELLUTO LINEN/VELVET	PELLE LEATHER
<b>3.300</b>	<b>3.449</b>	<b>3.685</b>
	<b>+ 5 %</b>	
	<b>+ 55</b>	
mc 0,28 – Kg 75		

SPAZIO UTILE CONTENITORE H. CM 16 – MISURE INTERNE 182X204  
STORAGE USEFUL SPACE H. CM 16 – INTERNAL DIMENSIONS 182X204

DON5632K			OPTIONAL
CAT. A	CAT. B	CAT. C	
ECOPELLE/ECONABUK ECOLEATHER/ECONABUK	LINO/VELLUTO LINEN/VELVET	PELLE LEATHER	BOX CONTENITORE STORAGE BED
<b>3.593</b>	<b>3.797</b>	<b>4.238</b>	
	<b>+ 5 %</b>		
	<b>+ 55</b>		<b>+ 750</b>
mc 0,37 – Kg 95			mc 0,40 – Kg 66

LETTO DA 180 – GIROLETTO LEGNO  
180 CM WIDE BED – WOODEN BED SURROUND



LETTO DA 180 – GIROLETTO LEGNO CON FASCIA IMBOTTITA  
180 CM WIDE BED – WOODEN AND UPHOLSTERED BED SURROUND



LETTO DA 180 GIROLETTO IMBOTTITO  
(CONTENITORE CON RETE BASCULANTE OPTIONAL)  
180 CM WIDE BED WITH UPHOLSTERED BED SURROUND  
(OPTIONAL BED STORAGE WITH TILTING BED BASE)

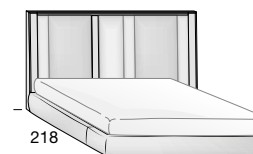

MISURE INTERNE 182X202 PER MATERASSO 180X200  
INTERNAL DIMENSIONS 182X202 FOR MATTRESS 180X200

DON5586K		
CAT. A	CAT. B	CAT. C
ECOPELLE/ECONABUK ECOLEATHER/ECONABUK	LINO/VELLUTO LINEN/VELVET	PELLE LEATHER
<b>3.054</b>	<b>3.145</b>	<b>3.264</b>
	<b>+ 5 %</b>	
<b>+ 55</b>		
<b>+ 105</b>	<b>+ 112</b>	<b>+ 173</b>
mc 0,28 – Kg 75		

MISURE INTERNE 182X202 PER MATERASSO 180X200  
INTERNAL DIMENSIONS 182X202 FOR MATTRESS 180X200

DON5576K		
CAT. A	CAT. B	CAT. C
ECOPELLE/ECONABUK ECOLEATHER/ECONABUK	LINO/VELLUTO LINEN/VELVET	PELLE LEATHER
<b>3.454</b>	<b>3.598</b>	<b>3.837</b>
	<b>+ 5 %</b>	
<b>+ 55</b>		
<b>+ 105</b>	<b>+ 112</b>	<b>+ 173</b>
mc 0,28 – Kg 75		

SPAZIO UTILE CONTENITORE H. CM 16 – MISURE INTERNE 182X204  
STORAGE USEFUL SPACE H. CM 16 – INTERNAL DIMENSIONS 182X204

DON5596K			OPTIONAL
CAT. A	CAT. B	CAT. C	
ECOPELLE/ECONABUK ECOLEATHER/ECONABUK	LINO/VELLUTO LINEN/VELVET	PELLE LEATHER	BOX CONTENITORE STORAGE BED
<b>3.753</b>	<b>3.957</b>	<b>4.379</b>	
	<b>+ 5 %</b>		
	<b>+ 55</b>		<b>+ 750</b>
mc 0,37 – Kg 95			mc 0,40 – Kg 66

LETTO DA 180 – GIROLETTO LEGNO  
180 CM WIDE BED – WOODEN BED SURROUND



LETTO DA 180 – GIROLETTO LEGNO CON FASCIA IMBOTTITA  
180 CM WIDE BED – WOODEN AND UPHOLSTERED BED SURROUND

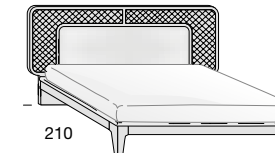

LETTO DA 180 GIROLETTO IMBOTTITO  
(CONTENITORE CON RETE BASCULANTE OPTIONAL)  
180 CM WIDE BED WITH UPHOLSTERED BED SURROUND  
(OPTIONAL BED STORAGE WITH TILTING BED BASE)

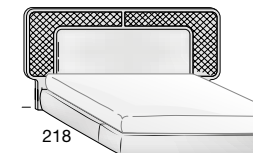

MISURE INTERNE 182X202 PER MATERASSO 180X200  
INTERNAL DIMENSIONS 182X202 FOR MATTRESS 180X200

DON5331K		
CAT. A	CAT. B	CAT. C
ECOPELLE/ECONABUK ECOLEATHER/ECONABUK	LINO/VELLUTO LINEN/VELVET	PELLE LEATHER
<b>3.411</b>	<b>3.548</b>	<b>4.000</b>
mc 0,28 – Kg 75		

MISURE INTERNE 182X202 PER MATERASSO 180X200  
INTERNAL DIMENSIONS 182X202 FOR MATTRESS 180X200

DON5341K		
CAT. A	CAT. B	CAT. C
ECOPELLE/ECONABUK ECOLEATHER/ECONABUK	LINO/VELLUTO LINEN/VELVET	PELLE LEATHER
<b>3.819</b>	<b>4.004</b>	<b>4.539</b>
mc 0,28 – Kg 75		

SPAZIO UTILE CONTENITORE H. CM 16 – MISURE INTERNE 182X204  
STORAGE USEFUL SPACE H. CM 16 – INTERNAL DIMENSIONS 182X204

DON5351K			OPTIONAL
CAT. A	CAT. B	CAT. C	
ECOPELLE/ECONABUK ECOLEATHER/ECONABUK	LINO/VELLUTO LINEN/VELVET	PELLE LEATHER	BOX CONTENITORE STORAGE BED
<b>4.080</b>	<b>4.539</b>	<b>5.008</b>	
			<b>+ 750</b>
mc 0,37 – Kg 95			mc 0,40 – Kg 66

MAGGIORAZIONI E RIDUZIONI  
SURCHARGES AND REDUCTIONS

PER LONGHERONI PIÙ LUNGI  
O PIÙ CORTI APPLICARE  
MAGG. DEL  
FOR LONGER OR SHORTER  
SIDES PLEASE ADD THE  
FOLLOWING EXTRA CHARGE

**+ 10%**



SOLLEVAMENTO  
ORIZZONTALE  
HORIZONTAL LIFTING  
MECHANISM

**+ 222**

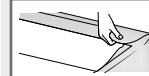

GIROLETTO CONTENITORE IMBOTTITO  
SFODERABILE  
UPHOLSTERED STORAGE BED  
SURROUND WITH REMOVABLE COVER

**+ 525**

RETE A DOGHE  
SLATTED BED BASE

RETE 160x200  
PER LETTI DA 160  
BED BASE 160x200  
FOR 160 CM WIDE BEDS

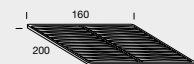

ACS5160K

**433**

RETE 180x200  
PER LETTI DA 180  
BED BASE 180x200  
FOR 180 CM WIDE BEDS



ACS5180K

**593**

KIT SUPPORTI PER RETI  
SINGOLE O RETI MOTORIZZATE  
KIT WITH SUPPORTS FOR SINGLE  
OR MOTORIZED BED BASE UNIT  
WITHS

ACS5191K

**235**

## LETTI BEDS

### LETTO BATTLO TESTIERA LEGNO BATTLO BED WOODEN HEADBOARD

LETTO DA 160 – GIROLETTO LEGNO  
160 CM WIDE BED – WOODEN BED SURROUND

LETTO DA 160 – GIROLETTO LEGNO CON FASCIA IMBOTTITA  
160 CM WIDE BED – WOODEN AND UPHOLSTERED BED SURROUND

LETTO DA 160 GIROLETTO IMBOTTITO  
(CONTENITORE CON RETE BASCULANTE OPTIONAL)  
160 CM WIDE BED WITH UPHOLSTERED BED SURROUND  
(OPTIONAL BED STORAGE WITH TILTING BED BASE)

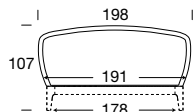

L.160

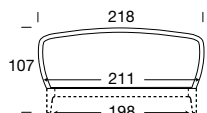
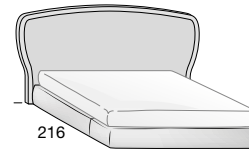
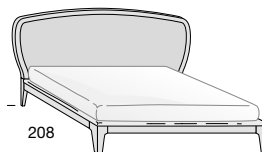

L.180

MISURE INTERNE 162X202 PER MATERASSO 160X200  
INTERNAL DIMENSIONS 162X202 FOR MATTRESS 160X200

MISURE INTERNE 162X202 PER MATERASSO 160X200  
INTERNAL DIMENSIONS 162X202 FOR MATTRESS 160X200

SPAZIO UTILE CONTENITORE H. CM 16 – MISURE INTERNE 162X204  
STORAGE USEFUL SPACE H. CM 16 – INTERNAL DIMENSIONS 162X204

DON5401K		
CAT. A	CAT. B	CAT. C
ECOPELLE/ECONABUK ECOLEATHER/ECONABUK	LINO/VELLUTO LINEN/VELVET	PELLE LEATHER
<b>2.477</b>		

DON5402K		
CAT. A	CAT. B	CAT. C
ECOPELLE/ECONABUK ECOLEATHER/ECONABUK	LINO/VELLUTO LINEN/VELVET	PELLE LEATHER
<b>2.886</b>	<b>3.293</b>	<b>3.472</b>

DON5412K			OPTIONAL
CAT. A	CAT. B	CAT. C	
ECOPELLE/ECONABUK ECOLEATHER/ECONABUK	LINO/VELLUTO LINEN/VELVET	PELLE LEATHER	BOX CONTENITORE STORAGE BED
<b>3.407</b>	<b>3.722</b>	<b>4.123</b>	<b>+ 680</b>

CANALETTO

mc 0,23 – Kg 65

mc 0,23 – Kg 65

mc 0,31 – Kg 85

mc 0,40 – Kg 66

### LETTO BATTLO TESTIERA IMBOTTITA BATTLO BED UPHOLSTERED HEADBOARD

LETTO DA 160 – GIROLETTO LEGNO  
160 CM WIDE BED – WOODEN BED SURROUND

LETTO DA 160 – GIROLETTO LEGNO CON FASCIA IMBOTTITA  
160 CM WIDE BED – WOODEN AND UPHOLSTERED BED SURROUND

LETTO DA 160 GIROLETTO IMBOTTITO  
(CONTENITORE E RETE BASCULANTE OPTIONAL)  
160 CM WIDE BED WITH UPHOLSTERED BED SURROUND  
(OPTIONAL BED STORAGE WITH TILTING BED BASE)

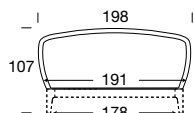

L.160

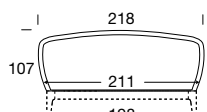

L.180

MISURE INTERNE 162X202 PER MATERASSO 160X200  
INTERNAL DIMENSIONS 162X202 FOR MATTRESS 160X200

MISURE INTERNE 162X202 PER MATERASSO 160X200  
INTERNAL DIMENSIONS 162X202 FOR MATTRESS 160X200

SPAZIO UTILE CONTENITORE H. CM 16 – MISURE INTERNE 162X204  
STORAGE USEFUL SPACE H. CM 16 – INTERNAL DIMENSIONS 162X204

DON5411K		
CAT. A	CAT. B	CAT. C
ECOPELLE/ECONABUK ECOLEATHER/ECONABUK	LINO/VELLUTO LINEN/VELVET	PELLE LEATHER
<b>2.545</b>	<b>2.892</b>	<b>2.961</b>

DON5422K		
CAT. A	CAT. B	CAT. C
ECOPELLE/ECONABUK ECOLEATHER/ECONABUK	LINO/VELLUTO LINEN/VELVET	PELLE LEATHER
<b>2.955</b>	<b>3.356</b>	<b>3.533</b>

DON5421K			OPTIONAL
CAT. A	CAT. B	CAT. C	
ECOPELLE/ECONABUK ECOLEATHER/ECONABUK	LINO/VELLUTO LINEN/VELVET	PELLE LEATHER	BOX CONTENITORE STORAGE BED
<b>3.475</b>	<b>3.790</b>	<b>4.179</b>	<b>+ 680</b>

CANALETTO

mc 0,23 – Kg 65

mc 0,23 – Kg 65

mc 0,31 – Kg 85

mc 0,40 – Kg 66

### LETTO BATTLO TESTIERA IMBOTTITA A DOGHE BATTLO BED SLATTED UPHOLSTERED HEADBOARD

LETTO DA 160 – GIROLETTO LEGNO  
160 CM WIDE BED – WOODEN BED SURROUND

LETTO DA 160 – GIROLETTO LEGNO CON FASCIA IMBOTTITA  
160 CM WIDE BED – WOODEN AND UPHOLSTERED BED SURROUND

LETTO DA 160 GIROLETTO IMBOTTITO  
(CONTENITORE E RETE BASCULANTE OPTIONAL)  
160 CM WIDE BED WITH UPHOLSTERED BED SURROUND  
(OPTIONAL BED STORAGE WITH TILTING BED BASE)

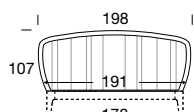

L.160

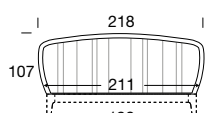
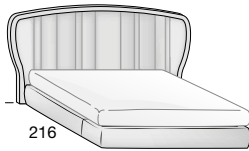

L.180

MISURE INTERNE 162X202 PER MATERASSO 160X200  
INTERNAL DIMENSIONS 162X202 FOR MATTRESS 160X200

MISURE INTERNE 162X202 PER MATERASSO 160X200  
INTERNAL DIMENSIONS 162X202 FOR MATTRESS 160X200

SPAZIO UTILE CONTENITORE H. CM 16 – MISURE INTERNE 162X204  
STORAGE USEFUL SPACE H. CM 16 – INTERNAL DIMENSIONS 162X204

DON5431K		
CAT. A	CAT. B	CAT. C
ECOPELLE/ECONABUK ECOLEATHER/ECONABUK	LINO/VELLUTO LINEN/VELVET	PELLE LEATHER
<b>3.059</b>	<b>3.189</b>	<b>3.225</b>

DON5432K		
CAT. A	CAT. B	CAT. C
ECOPELLE/ECONABUK ECOLEATHER/ECONABUK	LINO/VELLUTO LINEN/VELVET	PELLE LEATHER
<b>3.461</b>	<b>3.652</b>	<b>3.938</b>

DON5441K			OPTIONAL
CAT. A	CAT. B	CAT. C	
ECOPELLE/ECONABUK ECOLEATHER/ECONABUK	LINO/VELLUTO LINEN/VELVET	PELLE LEATHER	BOX CONTENITORE STORAGE BED
<b>3.772</b>	<b>4.080</b>	<b>4.455</b>	<b>+ 680</b>

CANALETTO

mc 0,23 – Kg 65

mc 0,23 – Kg 65

mc 0,31 – Kg 85

mc 0,40 – Kg 66



**LETTO DA 180 – GIROLETTO LEGNO**  
180 CM WIDE BED – WOODEN BED SURROUND

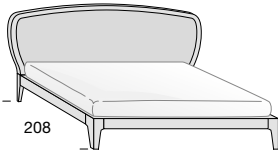

**LETTO DA 180 – GIROLETTO LEGNO CON FASCIA IMBOTTITA**  
180 CM WIDE BED – WOODEN AND UPHOLSTERED BED SURROUND

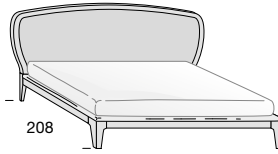

**LETTO DA 180 GIROLETTO IMBOTTITO**  
(CONTENITORE CON RETE BASCULANTE OPTIONAL)  
180 CM WIDE BED WITH UPHOLSTERED BED SURROUND  
(OPTIONAL BED STORAGE WITH TILTING BED BASE)

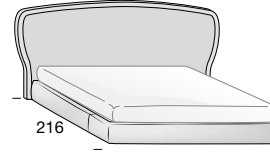

MISURE INTERNE 182X202 PER MATERASSO 180X200  
INTERNAL DIMENSIONS 182X202 FOR MATTRESS 180X200

DON5442K		
CAT. A	CAT. B	CAT. C
ECOPELLE/ECONABUK ECOLEATHER/ECONABUK	LINO/VELLUTO LINEN/VELVET	PELLE LEATHER
<b>2.743</b>		
mc 0,26 – Kg 75		

MISURE INTERNE 182X202 PER MATERASSO 180X200  
INTERNAL DIMENSIONS 182X202 FOR MATTRESS 180X200

DON5482K		
CAT. A	CAT. B	CAT. C
ECOPELLE/ECONABUK ECOLEATHER/ECONABUK	LINO/VELLUTO LINEN/VELVET	PELLE LEATHER
<b>3.145</b>	<b>3.560</b>	<b>3.713</b>
mc 0,26 – Kg 75		

SPAZIO UTILE CONTENITORE H. CM 16 – MISURE INTERNE 182X204  
STORAGE USEFUL SPACE H. CM 16 – INTERNAL DIMENSIONS 182X204

DON5492K			OPTIONAL
CAT. A	CAT. B	CAT. C	
ECOPELLE/ECONABUK ECOLEATHER/ECONABUK	LINO/VELLUTO LINEN/VELVET	PELLE LEATHER	BOX CONTENITORE STORAGE BED
<b>3.618</b>	<b>3.933</b>	<b>4.295</b>	<b>+ 750</b>
mc 0,35 – Kg 100			mc 0,40 – Kg 66

**LETTO DA 180 – GIROLETTO LEGNO**  
180 CM WIDE BED – WOODEN BED SURROUND



**LETTO DA 180 – GIROLETTO LEGNO CON FASCIA IMBOTTITA**  
180 CM WIDE BED – WOODEN AND UPHOLSTERED BED SURROUND

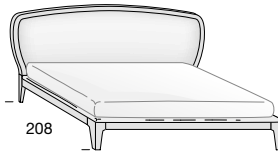

**LETTO DA 180 GIROLETTO IMBOTTITO**  
(CONTENITORE CON RETE BASCULANTE OPTIONAL)  
180 CM WIDE BED WITH UPHOLSTERED BED SURROUND  
(OPTIONAL BED STORAGE WITH TILTING BED BASE)

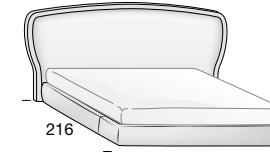

MISURE INTERNE 182X202 PER MATERASSO 180X200  
INTERNAL DIMENSIONS 182X202 FOR MATTRESS 180X200

DON5481K		
CAT. A	CAT. B	CAT. C
ECOPELLE/ECONABUK ECOLEATHER/ECONABUK	LINO/VELLUTO LINEN/VELVET	PELLE LEATHER
<b>2.812</b>	<b>3.164</b>	<b>3.203</b>
mc 0,26 – Kg 75		

MISURE INTERNE 182X202 PER MATERASSO 180X200  
INTERNAL DIMENSIONS 182X202 FOR MATTRESS 180X200

DON5462K		
CAT. A	CAT. B	CAT. C
ECOPELLE/ECONABUK ECOLEATHER/ECONABUK	LINO/VELLUTO LINEN/VELVET	PELLE LEATHER
<b>3.219</b>	<b>3.628</b>	<b>3.775</b>
mc 0,26 – Kg 75		

SPAZIO UTILE CONTENITORE H. CM 16 – MISURE INTERNE 182X204  
STORAGE USEFUL SPACE H. CM 16 – INTERNAL DIMENSIONS 182X204

DON5491K			OPTIONAL
CAT. A	CAT. B	CAT. C	
ECOPELLE/ECONABUK ECOLEATHER/ECONABUK	LINO/VELLUTO LINEN/VELVET	PELLE LEATHER	BOX CONTENITORE STORAGE BED
<b>3.685</b>	<b>4.000</b>	<b>4.356</b>	<b>+ 750</b>
mc 0,35 – Kg 100			mc 0,40 – Kg 66

**LETTO DA 180 – GIROLETTO LEGNO**  
180 CM WIDE BED – WOODEN BED SURROUND

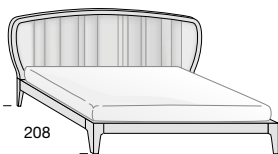

**LETTO DA 180 – GIROLETTO LEGNO CON FASCIA IMBOTTITA**  
180 CM WIDE BED – WOODEN AND UPHOLSTERED BED SURROUND

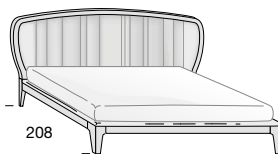

**LETTO DA 180 GIROLETTO IMBOTTITO**  
(CONTENITORE CON RETE BASCULANTE OPTIONAL)  
180 CM WIDE BED WITH UPHOLSTERED BED SURROUND  
(OPTIONAL BED STORAGE WITH TILTING BED BASE)

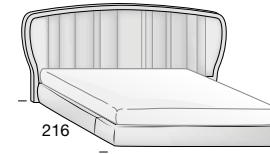

MISURE INTERNE 182X202 PER MATERASSO 180X200  
INTERNAL DIMENSIONS 182X202 FOR MATTRESS 180X200

DON5461K		
CAT. A	CAT. B	CAT. C
ECOPELLE/ECONABUK ECOLEATHER/ECONABUK	LINO/VELLUTO LINEN/VELVET	PELLE LEATHER
<b>3.325</b>	<b>3.449</b>	<b>3.472</b>
mc 0,26 – Kg 75		

MISURE INTERNE 182X202 PER MATERASSO 180X200  
INTERNAL DIMENSIONS 182X202 FOR MATTRESS 180X200

DON5472K		
CAT. A	CAT. B	CAT. C
ECOPELLE/ECONABUK ECOLEATHER/ECONABUK	LINO/VELLUTO LINEN/VELVET	PELLE LEATHER
<b>3.732</b>	<b>3.918</b>	<b>4.045</b>
mc 0,26 – Kg 75		

SPAZIO UTILE CONTENITORE H. CM 16 – MISURE INTERNE 182X204  
STORAGE USEFUL SPACE H. CM 16 – INTERNAL DIMENSIONS 182X204

DON5471K			OPTIONAL
CAT. A	CAT. B	CAT. C	
ECOPELLE/ECONABUK ECOLEATHER/ECONABUK	LINO/VELLUTO LINEN/VELVET	PELLE LEATHER	BOX CONTENITORE STORAGE BED
<b>3.982</b>	<b>4.297</b>	<b>4.632</b>	<b>+ 750</b>
mc 0,35 – Kg 100			mc 0,40 – Kg 66

## MAGGIORAZIONI E RIDUZIONI SURCHARGES AND REDUCTIONS

PER LONGHERONI PIÙ LUNGI  
O PIÙ CORTI APPLICARE  
MAGG. DEL  
FOR LONGER OR SHORTER  
SIDES PLEASE ADD THE  
FOLLOWING EXTRA CHARGE

**+ 10%**



SOLLEVAMENTO  
ORIZZONTALE  
HORIZONTAL LIFTING  
MECHANISM

**+ 222**



**+ 525**

GIROLETTO CONTENITORE IMBOTTITO  
SFODERABILE  
UPHOLSTERED STORAGE BED  
SURROUND WITH REMOVABLE COVER

## RETE A DOGHE SLATTED BED BASE

RETE 160x200  
PER LETTI DA 160  
BED BASE 160x200  
FOR 160 CM WIDE BEDS

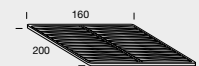

**ACS5160K**

**433**

RETE 180x200  
PER LETTI DA 180  
BED BASE 180x200  
FOR 180 CM WIDE BEDS



**ACS5180K**

**593**

KIT SUPPORTI PER RETI  
SINGOLE O RETI MOTORIZZATE  
KIT WITH SUPPORTS FOR SINGLE  
OR MOTORIZED BED BASE UNIT  
WITHS

**ACS5191K**

**235**

## LETTI BEDS

### LETTO RAINBOW H.90 - TESTIERA IMBOTTITA CON CUSCINI LISCI RAINBOW BED

H.90 - UPHOLSTERED HEADBOARD  
WITH PLAIN CUSHIONS

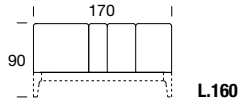

L.160

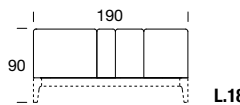

L.180

#### CANALETTO

Cuscini Multicolor / Multicolor cushions

LETTO DA 160 - GIROLETTO LEGNO  
160 CM WIDE BED - WOODEN BED SURROUND

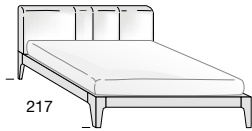

MISURE INTERNE 162X202 PER MATERASSO 160X200  
INTERNAL DIMENSIONS 162X202 FOR MATTRESS 160X200

DON5111K		
CAT. A	CAT. B	CAT. C
ECOPELLE/ECONABUK ECOLEATHER/ECONABUK	LINO/VELLUTO LINEN/VELVET	PELLE LEATHER
<b>2.848</b>	<b>2.960</b>	<b>3.376</b>
<b>+ 5 %</b>		

mc 0,34 - Kg 65

LETTO DA 160 - GIROLETTO LEGNO CON FASCIA IMBOTTITA  
160 CM WIDE BED - WOODEN AND UPHOLSTERED BED SURROUND

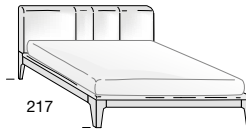

MISURE INTERNE 162X202 PER MATERASSO 160X200  
INTERNAL DIMENSIONS 162X202 FOR MATTRESS 160X200

DON5131K		
CAT. A	CAT. B	CAT. C
ECOPELLE/ECONABUK ECOLEATHER/ECONABUK	LINO/VELLUTO LINEN/VELVET	PELLE LEATHER
<b>3.219</b>	<b>3.386</b>	<b>3.904</b>
<b>+ 5 %</b>		

mc 0,34 - Kg 65

LETTO DA 160 GIROLETTO IMBOTTITO  
(CONTENITORE CON RETE BASCULANTE OPTIONAL)  
160 CM WIDE BED WITH UPHOLSTERED BED SURROUND  
(OPTIONAL BED STORAGE WITH TILTING BED BASE)

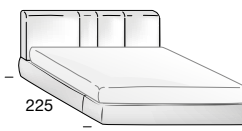

SPAZIO UTILE CONTENITORE H. CM 16 - MISURE INTERNE 162X204  
STORAGE USEFUL SPACE H. CM 16 - INTERNAL DIMENSIONS 162X204

DON5121K			OPTIONAL
CAT. A	CAT. B	CAT. C	
ECOPELLE/ECONABUK ECOLEATHER/ECONABUK	LINO/VELLUTO LINEN/VELVET	PELLE LEATHER	BOX CONTENITORE STORAGE BED
<b>3.579</b>	<b>3.685</b>	<b>4.006</b>	<b>+ 680</b>
<b>+ 5 %</b>			

mc 0,42 - Kg 85

### LETTO RAINBOW H.90 - TESTIERA IMBOTTITA CON 2 CUSCINI CUCITURA BARRÈ RAINBOW BED

H.90 - UPHOLSTERED HEADBOARD  
WITH 2 CUSHIONS WITH  
BARRÈ SEAM

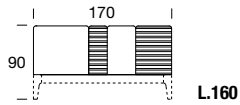

L.160

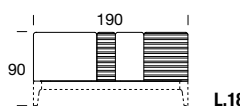

L.180

#### CANALETTO

Cuscini Multicolor / Multicolor cushions

LETTO DA 160 - GIROLETTO LEGNO  
160 CM WIDE BED - WOODEN BED SURROUND

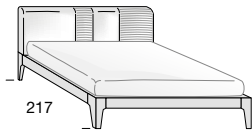

MISURE INTERNE 162X202 PER MATERASSO 160X200  
INTERNAL DIMENSIONS 162X202 FOR MATTRESS 160X200

DON5112K		
CAT. A	CAT. B	CAT. C
ECOPELLE/ECONABUK ECOLEATHER/ECONABUK	LINO/VELLUTO LINEN/VELVET	PELLE LEATHER
<b>3.015</b>	<b>3.121</b>	<b>3.528</b>
<b>+ 5 %</b>		

mc 0,34 - Kg 65

LETTO DA 160 - GIROLETTO LEGNO CON FASCIA IMBOTTITA  
160 CM WIDE BED - WOODEN AND UPHOLSTERED BED SURROUND

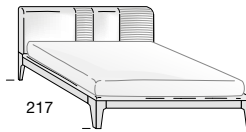

MISURE INTERNE 162X202 PER MATERASSO 160X200  
INTERNAL DIMENSIONS 162X202 FOR MATTRESS 160X200

DON5132K		
CAT. A	CAT. B	CAT. C
ECOPELLE/ECONABUK ECOLEATHER/ECONABUK	LINO/VELLUTO LINEN/VELVET	PELLE LEATHER
<b>3.386</b>	<b>3.553</b>	<b>4.056</b>
<b>+ 5 %</b>		

mc 0,34 - Kg 65

LETTO DA 160 GIROLETTO IMBOTTITO  
(CONTENITORE CON RETE BASCULANTE OPTIONAL)  
160 CM WIDE BED WITH UPHOLSTERED BED SURROUND  
(OPTIONAL BED STORAGE WITH TILTING BED BASE)

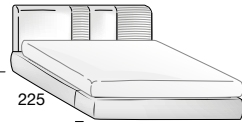

SPAZIO UTILE CONTENITORE H. CM 16 - MISURE INTERNE 162X204  
STORAGE USEFUL SPACE H. CM 16 - INTERNAL DIMENSIONS 162X204

DON5122K			OPTIONAL
CAT. A	CAT. B	CAT. C	
ECOPELLE/ECONABUK ECOLEATHER/ECONABUK	LINO/VELLUTO LINEN/VELVET	PELLE LEATHER	BOX CONTENITORE STORAGE BED
<b>3.747</b>	<b>3.858</b>	<b>4.151</b>	<b>+ 680</b>
<b>+ 5 %</b>			

mc 0,42 - Kg 85

### LETTO RAINBOW H.115 - TESTIERA IMBOTTITA CON CUSCINI LISCI RAINBOW BED

H.115 - UPHOLSTERED HEADBOARD  
WITH PLAIN CUSHIONS

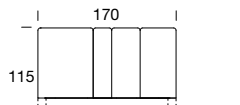

L.160

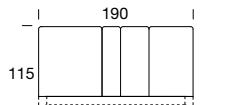

L.180

#### CANALETTO

Cuscini Multicolor / Multicolor cushions

LETTO DA 160 - GIROLETTO LEGNO  
160 CM WIDE BED - WOODEN BED SURROUND



MISURE INTERNE 162X202 PER MATERASSO 160X200  
INTERNAL DIMENSIONS 162X202 FOR MATTRESS 160X200

DON5901K		
CAT. A	CAT. B	CAT. C
ECOPELLE/ECONABUK ECOLEATHER/ECONABUK	LINO/VELLUTO LINEN/VELVET	PELLE LEATHER
<b>3.182</b>	<b>3.307</b>	<b>3.854</b>
<b>+ 5 %</b>		

mc 0,40 - Kg 75

LETTO DA 160 - GIROLETTO LEGNO CON FASCIA IMBOTTITA  
160 CM WIDE BED - WOODEN AND UPHOLSTERED BED SURROUND



MISURE INTERNE 162X202 PER MATERASSO 160X200  
INTERNAL DIMENSIONS 162X202 FOR MATTRESS 160X200

DON5911K		
CAT. A	CAT. B	CAT. C
ECOPELLE/ECONABUK ECOLEATHER/ECONABUK	LINO/VELLUTO LINEN/VELVET	PELLE LEATHER
<b>3.553</b>	<b>3.732</b>	<b>4.382</b>
<b>+ 5 %</b>		

mc 0,40 - Kg 75

LETTO DA 160 GIROLETTO IMBOTTITO  
(CONTENITORE CON RETE BASCULANTE OPTIONAL)  
160 CM WIDE BED WITH UPHOLSTERED BED SURROUND  
(OPTIONAL BED STORAGE WITH TILTING BED BASE)

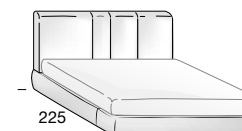

SPAZIO UTILE CONTENITORE H. CM 16 - MISURE INTERNE 162X204  
STORAGE USEFUL SPACE H. CM 16 - INTERNAL DIMENSIONS 162X204

DON5921K			OPTIONAL
CAT. A	CAT. B	CAT. C	
ECOPELLE/ECONABUK ECOLEATHER/ECONABUK	LINO/VELLUTO LINEN/VELVET	PELLE LEATHER	BOX CONTENITORE STORAGE BED
<b>3.920</b>	<b>4.087</b>	<b>4.932</b>	<b>+ 680</b>
<b>+ 5 %</b>			

mc 0,48 - Kg 95

### LETTO RAINBOW H.115 - TESTIERA IMBOTTITA CON 2 CUSCINI CUCITURA BARRÈ RAINBOW BED

H.115 - UPHOLSTERED HEADBOARD  
WITH 2 CUSHIONS WITH BARRÈ  
SEAM

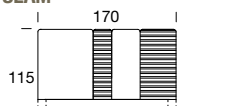

L.160

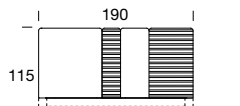

L.180

#### CANALETTO

Cuscini Multicolor / Multicolor cushions

LETTO DA 160 - GIROLETTO LEGNO  
160 CM WIDE BED - WOODEN BED SURROUND

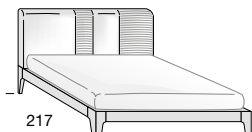

MISURE INTERNE 162X202 PER MATERASSO 160X200  
INTERNAL DIMENSIONS 162X202 FOR MATTRESS 160X200

DON5902K		
CAT. A	CAT. B	CAT. C
ECOPELLE/ECONABUK ECOLEATHER/ECONABUK	LINO/VELLUTO LINEN/VELVET	PELLE LEATHER
<b>3.350</b>	<b>3.466</b>	<b>4.000</b>
<b>+ 5 %</b>		

mc 0,40 - Kg 75

LETTO DA 160 - GIROLETTO LEGNO CON FASCIA IMBOTTITA  
160 CM WIDE BED - WOODEN AND UPHOLSTERED BED SURROUND

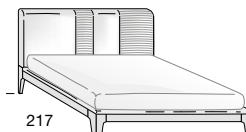

MISURE INTERNE 162X202 PER MATERASSO 160X200  
INTERNAL DIMENSIONS 162X202 FOR MATTRESS 160X200

DON5912K		
CAT. A	CAT. B	CAT. C
ECOPELLE/ECONABUK ECOLEATHER/ECONABUK	LINO/VELLUTO LINEN/VELVET	PELLE LEATHER
<b>3.720</b>	<b>3.900</b>	<b>4.528</b>
<b>+ 5 %</b>		

mc 0,40 - Kg 75

LETTO DA 160 GIROLETTO IMBOTTITO  
(CONTENITORE CON RETE BASCULANTE OPTIONAL)  
160 CM WIDE BED WITH UPHOLSTERED BED SURROUND  
(OPTIONAL BED STORAGE WITH TILTING BED BASE)

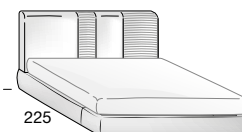

SPAZIO UTILE CONTENITORE H. CM 16 - MISURE INTERNE 162X204  
STORAGE USEFUL SPACE H. CM 16 - INTERNAL DIMENSIONS 162X204

DON5922K			OPTIONAL
CAT. A	CAT. B	CAT. C	
ECOPELLE/ECONABUK ECOLEATHER/ECONABUK	LINO/VELLUTO LINEN/VELVET	PELLE LEATHER	BOX CONTENITORE STORAGE BED
<b>4.086</b>	<b>4.253</b>	<b>5.084</b>	<b>+ 680</b>
<b>+ 5 %</b>			

mc 0,48 - Kg 95

**LETTO DA 180 – GIROLETTO LEGNO**  
180 CM WIDE BED – WOODEN BED SURROUND



217

MISURE INTERNE 182X202 PER MATERASSO 180X200  
INTERNAL DIMENSIONS 182X202 FOR MATTRESS 180X200

DON5181K		
CAT. A	CAT. B	CAT. C
ECOPELLE/ECONABUK ECOLEATHER/ECONABUK	LINO/VELLUTO LINEN/VELVET	PELLE LEATHER
<b>3.095</b>	<b>3.213</b>	<b>3.607</b>
<b>+ 5 %</b>		
mc 0,38 – Kg 75		

**LETTO DA 180 – GIROLETTO LEGNO CON FASCIA IMBOTTITA**  
180 CM WIDE BED – WOODEN AND UPHOLSTERED BED SURROUND



217

MISURE INTERNE 182X202 PER MATERASSO 180X200  
INTERNAL DIMENSIONS 182X202 FOR MATTRESS 180X200

DON5171K		
CAT. A	CAT. B	CAT. C
ECOPELLE/ECONABUK ECOLEATHER/ECONABUK	LINO/VELLUTO LINEN/VELVET	PELLE LEATHER
<b>3.466</b>	<b>3.639</b>	<b>4.134</b>
<b>+ 5 %</b>		
mc 0,38 – Kg 75		

**LETTO DA 180 GIROLETTO IMBOTTITO**  
(CONTENITORE CON RETE BASCULANTE OPTIONAL)  
180 CM WIDE BED WITH UPHOLSTERED BED SURROUND  
(OPTIONAL BED STORAGE WITH TILTING BED BASE)

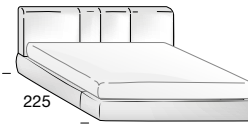

225

SPAZIO UTILE CONTENITORE H. CM 16 – MISURE INTERNE 182X204  
STORAGE USEFUL SPACE H. CM 16 – INTERNAL DIMENSIONS 182X204

DON5191K			OPTIONAL
CAT. A	CAT. B	CAT. C	
ECOPELLE/ECONABUK ECOLEATHER/ECONABUK	LINO/VELLUTO LINEN/VELVET	PELLE LEATHER	BOX CONTENITORE STORAGE BED
<b>3.777</b>	<b>3.883</b>	<b>4.166</b>	<b>+ 750</b>
<b>+ 5 %</b>			mc 0,40 – Kg 66
mc 0,47 – Kg 100			

**LETTO DA 180 – GIROLETTO LEGNO**  
180 CM WIDE BED – WOODEN BED SURROUND

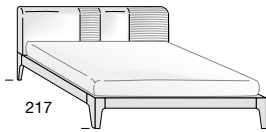

217

MISURE INTERNE 182X202 PER MATERASSO 180X200  
INTERNAL DIMENSIONS 182X202 FOR MATTRESS 180X200

DON5182K		
CAT. A	CAT. B	CAT. C
ECOPELLE/ECONABUK ECOLEATHER/ECONABUK	LINO/VELLUTO LINEN/VELVET	PELLE LEATHER
<b>3.268</b>	<b>3.375</b>	<b>3.758</b>
<b>+ 5 %</b>		
mc 0,38 – Kg 75		

**LETTO DA 180 – GIROLETTO LEGNO CON FASCIA IMBOTTITA**  
180 CM WIDE BED – WOODEN AND UPHOLSTERED BED SURROUND

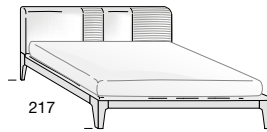

217

MISURE INTERNE 182X202 PER MATERASSO 180X200  
INTERNAL DIMENSIONS 182X202 FOR MATTRESS 180X200

DON5172K		
CAT. A	CAT. B	CAT. C
ECOPELLE/ECONABUK ECOLEATHER/ECONABUK	LINO/VELLUTO LINEN/VELVET	PELLE LEATHER
<b>3.639</b>	<b>3.806</b>	<b>4.281</b>
<b>+ 5 %</b>		
mc 0,38 – Kg 75		

**LETTO DA 180 GIROLETTO IMBOTTITO**  
(CONTENITORE CON RETE BASCULANTE OPTIONAL)  
180 CM WIDE BED WITH UPHOLSTERED BED SURROUND  
(OPTIONAL BED STORAGE WITH TILTING BED BASE)

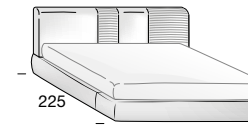

225

SPAZIO UTILE CONTENITORE H. CM 16 – MISURE INTERNE 182X204  
STORAGE USEFUL SPACE H. CM 16 – INTERNAL DIMENSIONS 182X204

DON5192K			OPTIONAL
CAT. A	CAT. B	CAT. C	
ECOPELLE/ECONABUK ECOLEATHER/ECONABUK	LINO/VELLUTO LINEN/VELVET	PELLE LEATHER	BOX CONTENITORE STORAGE BED
<b>3.939</b>	<b>4.056</b>	<b>4.311</b>	<b>+ 750</b>
<b>+ 5 %</b>			mc 0,40 – Kg 66
mc 0,47 – Kg 100			

**LETTO DA 180 – GIROLETTO LEGNO**  
180 CM WIDE BED – WOODEN BED SURROUND



217

MISURE INTERNE 182X202 PER MATERASSO 180X200  
INTERNAL DIMENSIONS 182X202 FOR MATTRESS 180X200

DON5931K		
CAT. A	CAT. B	CAT. C
ECOPELLE/ECONABUK ECOLEATHER/ECONABUK	LINO/VELLUTO LINEN/VELVET	PELLE LEATHER
<b>3.430</b>	<b>3.560</b>	<b>4.084</b>
<b>+ 5 %</b>		
mc 0,44 – Kg 85		

**LETTO DA 180 – GIROLETTO LEGNO CON FASCIA IMBOTTITA**  
180 CM WIDE BED – WOODEN AND UPHOLSTERED BED SURROUND



217

MISURE INTERNE 182X202 PER MATERASSO 180X200  
INTERNAL DIMENSIONS 182X202 FOR MATTRESS 180X200

DON5941K		
CAT. A	CAT. B	CAT. C
ECOPELLE/ECONABUK ECOLEATHER/ECONABUK	LINO/VELLUTO LINEN/VELVET	PELLE LEATHER
<b>3.806</b>	<b>3.985</b>	<b>4.612</b>
<b>+ 5 %</b>		
mc 0,44 – Kg 85		

**LETTO DA 180 GIROLETTO IMBOTTITO**  
(CONTENITORE CON RETE BASCULANTE OPTIONAL)  
180 CM WIDE BED WITH UPHOLSTERED BED SURROUND  
(OPTIONAL BED STORAGE WITH TILTING BED BASE)



225

SPAZIO UTILE CONTENITORE H. CM 16 – MISURE INTERNE 182X204  
STORAGE USEFUL SPACE H. CM 16 – INTERNAL DIMENSIONS 182X204

DON5951K			OPTIONAL
CAT. A	CAT. B	CAT. C	
ECOPELLE/ECONABUK ECOLEATHER/ECONABUK	LINO/VELLUTO LINEN/VELVET	PELLE LEATHER	BOX CONTENITORE STORAGE BED
<b>4.118</b>	<b>4.286</b>	<b>5.092</b>	<b>+ 750</b>
<b>+ 5 %</b>			mc 0,40 – Kg 66
mc 0,42 – Kg 105			

**LETTO DA 180 – GIROLETTO LEGNO**  
180 CM WIDE BED – WOODEN BED SURROUND

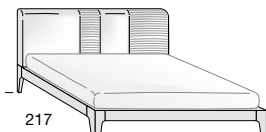

217

MISURE INTERNE 182X202 PER MATERASSO 180X200  
INTERNAL DIMENSIONS 182X202 FOR MATTRESS 180X200

DON5932K		
CAT. A	CAT. B	CAT. C
ECOPELLE/ECONABUK ECOLEATHER/ECONABUK	LINO/VELLUTO LINEN/VELVET	PELLE LEATHER
<b>3.603</b>	<b>3.850</b>	<b>4.230</b>
<b>+ 5 %</b>		
mc 0,44 – Kg 85		

**LETTO DA 180 – GIROLETTO LEGNO CON FASCIA IMBOTTITA**  
180 CM WIDE BED – WOODEN AND UPHOLSTERED BED SURROUND

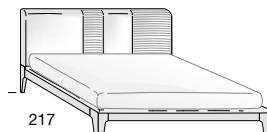

217

MISURE INTERNE 182X202 PER MATERASSO 180X200  
INTERNAL DIMENSIONS 182X202 FOR MATTRESS 180X200

DON5942K		
CAT. A	CAT. B	CAT. C
ECOPELLE/ECONABUK ECOLEATHER/ECONABUK	LINO/VELLUTO LINEN/VELVET	PELLE LEATHER
<b>3.850</b>	<b>4.153</b>	<b>4.758</b>
<b>+ 5 %</b>		
mc 0,44 – Kg 85		

**LETTO DA 180 GIROLETTO IMBOTTITO**  
(CONTENITORE CON RETE BASCULANTE OPTIONAL)  
180 CM WIDE BED WITH UPHOLSTERED BED SURROUND  
(OPTIONAL BED STORAGE WITH TILTING BED BASE)

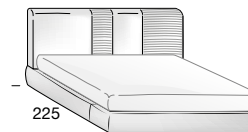

225

SPAZIO UTILE CONTENITORE H. CM 16 – MISURE INTERNE 182X204  
STORAGE USEFUL SPACE H. CM 16 – INTERNAL DIMENSIONS 182X204

DON5952K			OPTIONAL
CAT. A	CAT. B	CAT. C	
ECOPELLE/ECONABUK ECOLEATHER/ECONABUK	LINO/VELLUTO LINEN/VELVET	PELLE LEATHER	BOX CONTENITORE STORAGE BED
<b>4.286</b>	<b>4.452</b>	<b>5.239</b>	<b>+ 750</b>
<b>+ 5 %</b>			mc 0,40 – Kg 66
mc 0,42 – Kg 105			

### MAGGIORAZIONI E RIDUZIONI SURCHARGES AND REDUCTIONS

PER LONGHERONI PIÙ LUNGI  
O PIÙ CORTI APPLICARE  
MAGG. DEL  
FOR LONGER OR SHORTER  
SIDES PLEASE ADD THE  
FOLLOWING EXTRA CHARGE

**+ 10%**



SOLLEVAMENTO  
ORIZZONTALE  
HORIZONTAL LIFTING  
MECHANISM

**+ 222**



GIROLETTO CONTENITORE IMBOTTITO  
SFODERABILE  
UPHOLSTERED STORAGE BED  
SURROUND WITH REMOVABLE COVER

**+ 525**

### RETE A DOGHE SLATTED BED BASE

RETE 160x200  
PER LETTI DA 160  
BED BASE 160x200  
FOR 160 CM WIDE BEDS

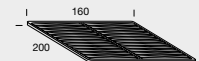

### ACS5160K

**433**

RETE 180x200  
PER LETTI DA 180  
BED BASE 180x200  
FOR 180 CM WIDE BEDS



### ACS5180K

**593**

KIT SUPPORTI PER RETI  
SINGOLE O RETI MOTORIZZATE  
KIT WITH SUPPORTS FOR SINGLE  
OR MOTORIZED BED BASE UNIT  
WITHS

### ACS5191K

**235**

## ARMADI SCORREVOLI SLIDING DOOR WARDROBES

### DOMINO 2 SPECCHI DOMINO 2 MIRRORS

2 ANTE SCORREVOLI CON 2 SPECCHI VERTICALI  
SLIDING DOORS WITH 2 VERTICAL MIRRORS

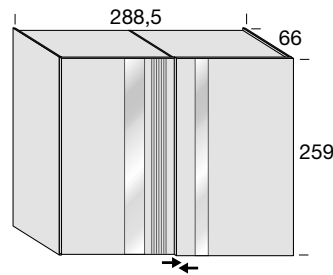

**ATTREZZATURA INTERNA:**  
2 RIPIANI 4 TUBI APPENDIABILI

**INTERIOR FITTINGS:**  
2 SHELVES, 4 CLOTHES HANGING RAILS

MAGG. FIANCHI ESTERNI IN NOCE  
CANALETTO OBBLIGATORIO PER  
FINITURA OLIO, CONSIGLIATO PER  
FINITURA HAVANA E ORIGINE  
SURCH. FOR EXTERNAL SIDES IN  
CANALETTO WALNUT, COMPULSORY  
FOR OLIO FINISH, RECOMMENDED FOR  
HAVANA AND ORIGINE FINISH + 321

DOGA LEGNO LISCIA  
SPECIFICARE SE SPECCHI ARGENTO, BRONZO O FUMÉ  
PLAIN WOODEN SLAT  
SPECIFY MIRRORS COLOR: SILVER, BRONZE OR SMOKED

DOGA LEGNO LISCIA PLAIN WOODEN SLAT	DOGA SLAT		
DON8006K	ACS3100K L. 140 H. 56	DOGA RIGHE RIBBED SLAT	DOGA QUADRO LEGNO WOODEN SQUARE SLAT
5.172	+ 470	+ 297	+ 347
mc 1,45 – Kg 130	mc 0,44 – Kg 54		

### DOMINO 3 SPECCHI DOMINO 3 MIRRORS

2 ANTE SCORREVOLI CON 3 SPECCHI VERTICALI  
SLIDING DOORS WITH 3 VERTICAL MIRRORS

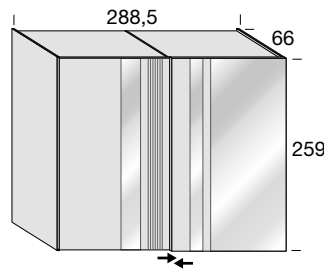

**ATTREZZATURA INTERNA:**  
2 RIPIANI 4 TUBI APPENDIABILI

**INTERIOR FITTINGS:**  
2 SHELVES, 4 CLOTHES HANGING RAILS

MAGG. FIANCHI ESTERNI IN NOCE  
CANALETTO OBBLIGATORIO PER  
FINITURA OLIO, CONSIGLIATO PER  
FINITURA HAVANA E ORIGINE  
SURCH. FOR EXTERNAL SIDES IN  
CANALETTO WALNUT, COMPULSORY  
FOR OLIO FINISH, RECOMMENDED FOR  
HAVANA AND ORIGINE FINISH + 321

DOGA LEGNO LISCIA  
SPECIFICARE SE SPECCHI ARGENTO, BRONZO O FUMÉ  
PLAIN WOODEN SLAT  
SPECIFY MIRRORS COLOR: SILVER, BRONZE OR SMOKED

DOGA LEGNO LISCIA PLAIN WOODEN SLAT	DOGA SLAT		
DON8026K	ACS3100K L. 140 H. 56	DOGA RIGHE RIBBED SLAT	DOGA QUADRO LEGNO WOODEN SQUARE SLAT
5.388	+ 470	+ 297	+ 347
mc 1,45 – Kg 130	mc 0,44 – Kg 54		

**ATTREZZATURA INTERNA**  
DECORATIVO COLOR  
OLMO SBIANCATO  
**INTERIOR FITTINGS**  
BLEACHED ELM  
DECORATIVE COLOR

DIVISORIO INTERNO SP. 2.5  
INTERNAL PARTITIONS TH. 2.5

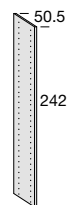

ACS1022C
415
mc 0,10 – Kg 24

DIVISORIO INTERNO SP. 2.5  
INTERNAL PARTITIONS TH. 2.5

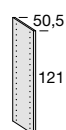

ACS1021C
222
mc 0,05 – Kg 10

KIT 2 LUCI LED IN ALLUMINIO  
VERTICALI H. 240  
KIT 2 ALUMINUM VERTICAL LED  
LIGHTS



CON SENSORE E TRASFORMATORE (1 DX E 1 SX)  
WITH SENSOR AND TRANSFORMER (1 RH AND 1 LH)

ACS1080K
637

KIT DI 2 DEPURATORI  
D'ARIA CON SISTEMA  
AIRLIGHTPRO UV-A  
KIT OF 2 PURIFIERS  
AIR WITH SYSTEM  
AIRLIGHTPRO UV-A



PER RICAMBI FILTRI  
RIVOLGERSI A:  
FOR FILTER SPARE PARTS  
CONTACT:  
INFO@METALARREDO.IT

ACS1190K
656

STRUTTURA INTERNA DECORATIVO COLOR OLMO SBIANCATO ED ESTERNO NOCE TANGANIKA  
 STRUCTURE INSIDE IN BLEACHED ELM DECORATIVE COLOR AND OUTSIDE IN TANGANIKA WALNUT

## HOLA ANTE LEGNO HOLA WOODEN DOORS

**NEW**

**ATTREZZATURA INTERNA:  
2 RIPIANI 4 TUBI APPENDIABILI**

**INTERIOR FITTINGS:  
2 SHELVES, 4 CLOTHES HANGING RAILS**

MAGG. FIANCHI ESTERNI IN NOCE  
 CANALETTO OBBLIGATORIO PER  
 FINITURA OLIO, CONSIGLIATO PER  
 FINITURA HAVANA E ORIGINE  
 SURCH. FOR EXTERNAL SIDES IN  
 CANALETTO WALNUT, COMPULSORY  
 FOR OLIO FINISH, RECOMMENDED FOR  
 HAVANA AND ORIGINE FINISH + 321

**CANALETTO**

2 ANTE SCORREVOLI CON FASCIA DECORATIVA IN LEGNO  
 2 SLIDING DOORS WITH DECORATIVE WOODEN BAND

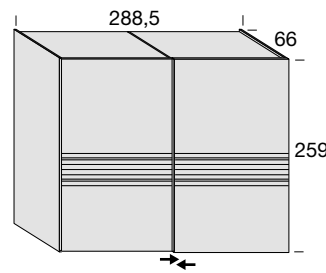

SHN8011K	OPTIONAL			
	ACS3100K L. 140 H. 56	FASCIA BAND		
		SAHARA NOIRE KALACATTA	SILVER / GOLD / SP FUMÉ SILVER / GOLD / SMOKED M.	BICOLORE BICOLOR
<b>5.567</b>	+ 470	+ 729	+ 488	+ 5%
mc 1,45 – Kg 130	mc 0,44 – Kg 54			

## HOLA 1 ANTA LEGNO, 1 ANTA SPECCHIO HOLA 1 WOODEN DOOR, 1 MIRROR DOOR

**NEW**

**ATTREZZATURA INTERNA:  
2 RIPIANI 4 TUBI APPENDIABILI**

**INTERIOR FITTINGS:  
2 SHELVES, 4 CLOTHES HANGING RAILS**

MAGG. FIANCHI ESTERNI IN NOCE  
 CANALETTO OBBLIGATORIO PER  
 FINITURA OLIO, CONSIGLIATO PER  
 FINITURA HAVANA E ORIGINE  
 SURCH. FOR EXTERNAL SIDES IN  
 CANALETTO WALNUT, COMPULSORY  
 FOR OLIO FINISH, RECOMMENDED FOR  
 HAVANA AND ORIGINE FINISH + 321

**CANALETTO**

2 ANTE SCORREVOLI CON FASCIA DECORATIVA IN LEGNO  
 2 SLIDING DOORS WITH DECORATIVE WOODEN BAND

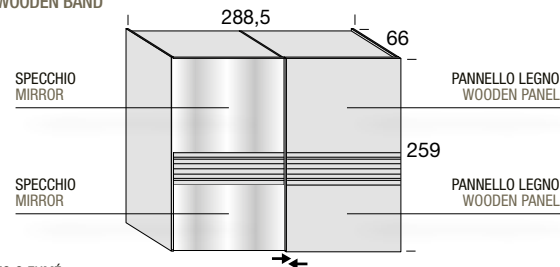

SPECIFICARE SE SPECCHI ARGENTO, BRONZO O FUMÉ  
 SPECIFY MIRRORS COLOR: SILVER, BRONZE OR SMOKED

SHN8001K	OPTIONAL			
	ACS3100K L. 140 H. 56	FASCIA BAND		
		SAHARA NOIRE KALACATTA	SILVER / GOLD / SP FUMÉ SILVER / GOLD / SMOKED M.	BICOLORE BICOLOR
<b>5.703</b>	+ 470	+ 729	+ 488	+ 5%
mc 1,45 – Kg 130	mc 0,44 – Kg 54			

### MAGGIORAZIONI E RIDUZIONI SURCHARGES AND REDUCTIONS

RIDUZIONI SINGOLE  
SINGLE ADJUSTMENTS

LUNGHEZZA LENGTH	+ 30%
PROFONDITÀ DEPTH	
ALTEZZA HEIGHT	

RIDUZIONI COMBinate TRA LORO  
COMBINED ADJUSTMENTS

RIDUZIONE DI 2 MISURE REDUCTION OF 2 DIMENSIONS	+ 40%
--	-------

ES. RIDUZIONE IN LUNGHEZZA +  
 PROFONDITÀ O PROFONDITÀ + ALTEZZA ECC.  
 EX. OF REDUCTION IN LENGTH +  
 DEPTH OR DEPTH + HEIGHT ETC.

RIPIANI SP. 4 CM  
SHELVES TH. 4 CM



TUBO APPENDIABILI  
CLOTHES HANGING RAILS



ACS1014C ACS1013C ACS1012C ACS1016C ACS1011C

L. 45 L. 70 L. 90 L. 100 L. 140

136 162 186 229 241

mc 0,04 – Kg 4 mc 0,05 – Kg 8 mc 0,05 – Kg 11 mc 0,06 – Kg 13 mc 0,07 – Kg 15

ACS1104C ACS1103C ACS1102C ACS1106C ACS1101C

L. 45 L. 70 L. 90 L. 100 L. 140

44 44 55 55 55

# NOTTE - NIGHT

## ARMADI SCORREVOLI SLIDING DOOR WARDROBES

### SWING

2 ANTE SCORREVOLI CON 2 SPECCHI ORIZZONTALI  
SLIDING DOORS WITH 2 HORIZONTAL MIRRORS

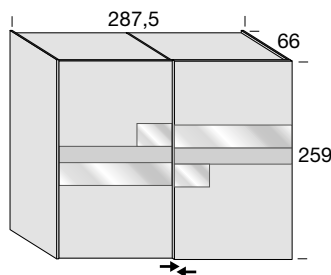

**ATTREZZATURA INTERNA:**  
2 RIPIANI 4 TUBI APPENDIABILI

**INTERIOR FITTINGS:**  
2 SHELVES, 4 CLOTHES HANGING RAILS

MAGG. FIANCHI ESTERNI IN NOCE  
CANALETTO OBBLIGATORIO PER  
FINITURA OLIO, CONSIGLIATO PER  
FINITURA HAVANA E ORIGINE  
SURCH. FOR EXTERNAL SIDES IN  
CANALETTO WALNUT, COMPULSORY  
FOR OILIO FINISH, RECOMMENDED FOR  
HAVANA AND ORIGINE FINISH

+ 321

DOGA LEGNO LISCIA  
SPECIFICARE SE SPECCHI ARGENTO, BRONZO O FUMÉ  
PLAIN WOODEN SLAT  
SPECIFY MIRRORS COLOR: SILVER, BRONZE OR SMOKED

DON8036K	OPTIONAL		
	ACS3100K L. 140 H. 56	DOGA RIGHE RIBBED SLAT	DOGA SLAT DOGA QUADRO LEGNO WOODEN SQUARE SLAT
5.394	+ 470	+ 297	+ 347
mc 1,45 - Kg 130	mc 0,44 - Kg 54		

### JAZZ

2 ANTE SCORREVOLI CON 3 SPECCHI OBLIQUI  
2 SLIDING DOORS WITH 3 OBLIQUE MIRRORS

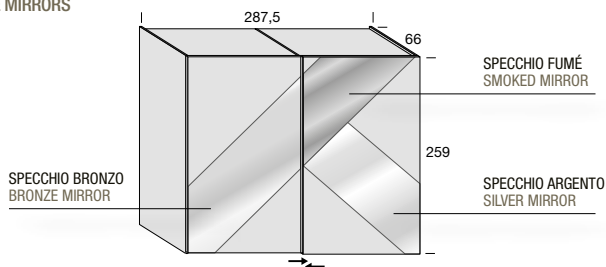

**ATTREZZATURA INTERNA:**  
2 RIPIANI 4 TUBI APPENDIABILI

**INTERIOR FITTINGS:**  
2 SHELVES, 4 CLOTHES HANGING RAILS

MAGG. FIANCHI ESTERNI IN NOCE  
CANALETTO OBBLIGATORIO PER  
FINITURA OLIO, CONSIGLIATO PER  
FINITURA HAVANA E ORIGINE  
SURCH. FOR EXTERNAL SIDES IN  
CANALETTO WALNUT, COMPULSORY  
FOR OILIO FINISH, RECOMMENDED FOR  
HAVANA AND ORIGINE FINISH

+ 321

SPECCHI ARGENTO, BRONZO E FUMÉ  
SILVER, BRONZE AND SMOKED MIRRORS

DON8101K	OPTIONAL		
	ACS3100K L. 140 H. 56		
6.043	+ 470		
mc 1,30 - Kg 130	mc 0,44 - Kg 54		

### DIXIELAND

2 ANTE SCORREVOLI CON 2 SPECCHI VERTICALI E 1 SPECCHIO ORIZZONTALE  
2 SLIDING DOORS WITH 2 VERTICAL MIRRORS AND 1 HORIZONTAL MIRROR

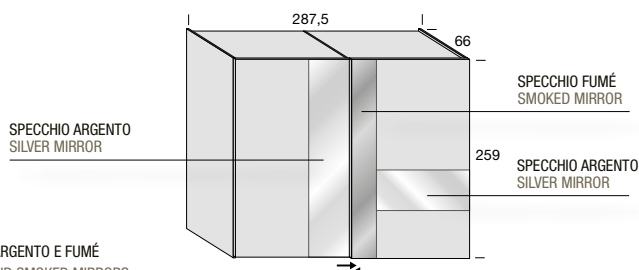

**ATTREZZATURA INTERNA:**  
2 RIPIANI 4 TUBI APPENDIABILI

**INTERIOR FITTINGS:**  
2 SHELVES, 4 CLOTHES HANGING RAILS

MAGG. FIANCHI ESTERNI IN NOCE  
CANALETTO OBBLIGATORIO PER  
FINITURA OLIO, CONSIGLIATO PER  
FINITURA HAVANA E ORIGINE  
SURCH. FOR EXTERNAL SIDES IN  
CANALETTO WALNUT, COMPULSORY  
FOR OILIO FINISH, RECOMMENDED FOR  
HAVANA AND ORIGINE FINISH

+ 321

DOGA LEGNO LISCIA - SPECCHI ARGENTO E FUMÉ  
PLAIN WOODEN SLAT - SILVER AND SMOKED MIRRORS

DON8091K	OPTIONAL		
	ACS3100K L. 140 H. 56		
5.320	+ 470		
mc 1,30 - Kg 130	mc 0,44 - Kg 54		

### ATTREZZATURA INTERNA DECORATIVO COLOR OLMO SBIANCATO

**INTERIOR FITTINGS**  
BLEACHED ELM DECORATIVE  
COLOR

DIVISORIO INTERNO SP. 2.5  
INTERNAL PARTITIONS TH. 2.5

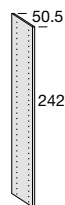

ACS1022C

415

mc 0,10 - Kg 24

DIVISORIO INTERNO SP. 2.5  
INTERNAL PARTITIONS TH. 2.5

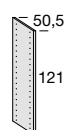

ACS1021C

222

mc 0,05 - Kg 10

KIT 2 LUCI LED IN ALLUMINIO  
VERTICALI H. 240  
KIT 2 ALUMINUM VERTICAL LED  
LIGHTS



ACS1080K

637

CON SENSORE E TRASFORMATORE (1 DX E 1 SX)  
WITH SENSOR AND TRANSFORMER (1 RH AND 1 LH)

KIT DI 2 DEPURATORI  
D'ARIA CON SISTEMA  
AIRLIGHTPRO UV-A  
KIT OF 2 PURIFIERS  
AIR WITH SYSTEM  
AIRLIGHTPRO UV-A



ACS1190K

656

PER RICAMBI FILTRI  
RIVOLGERSI A:  
FOR FILTER SPARE PARTS  
CONTACT:  
INFO@METALARREDO.IT

## ARMADI BATTENTE HINGED DOOR WARDROBES

STRUTTURA INTERNA DECORATIVO COLOR OLMO SBIANCATO ED ESTERNO NOCE TANGANICA  
STRUCTURE INSIDE IN BLEACHED ELM DECORATIVE COLOR AND OUTSIDE IN TANGANICA WALNUT

### HOLA 4 ANTE HOLA 4 DOORS

**NEW**

ATTREZZATURA INTERNA:  
2 RIPIANI 4 TUBI APPENDIABILI

INTERIOR FITTINGS:  
2 SHELVES, 4 CLOTHES HANGING RAILS

MAGG. FIANCHI ESTERNI IN NOCE  
CANALETTO OBBLIGATORIO PER  
FINITURA OLIO, CONSIGLIATO PER  
FINITURA HAVANA E ORIGINE  
SURCH. FOR EXTERNAL SIDES IN  
CANALETTO WALNUT, COMPULSORY  
FOR OILY FINISH, RECOMMENDED FOR  
HAVANA AND ORIGINE FINISH

**+ 321**

CANALETTO

4 ANTE BATTENTE CON FASCIA DECORATIVA IN LEGNO  
4 HINGED DOORS WITH DECORATIVE WOODEN BAND

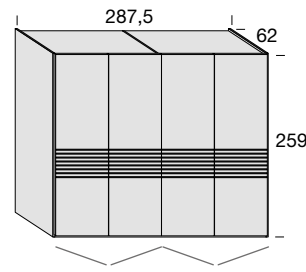

APERTURA 2 MANIGLIE IN LEGNO MASSELLO - OPENING WITH 2 SOLID WOOD HANDLES

SHN8201K	OPTIONAL			
	ACS3100K L. 140 H. 56	FASCIA BAND		
		SAHARA NOIRE KALACATTA	SILVER / GOLD / SP FUMÉ SILVER / GOLD / SMOKED M.	BICOLORE BICOLOR
<b>5.888</b>	<b>+ 470</b>	<b>+ 729</b>	<b>+ 488</b>	<b>+ 5%</b>
mc 1,30 - Kg 130	mc 0,44 - Kg 54			

### HOLA 6 ANTE HOLA 6 DOORS

**NEW**

ATTREZZATURA INTERNA:  
3 RIPIANI 6 TUBI APPENDIABILI

INTERIOR FITTINGS:  
3 SHELVES, 6 CLOTHES HANGING RAILS

MAGG. FIANCHI ESTERNI IN NOCE  
CANALETTO OBBLIGATORIO PER  
FINITURA OLIO, CONSIGLIATO PER  
FINITURA HAVANA E ORIGINE  
SURCH. FOR EXTERNAL SIDES IN  
CANALETTO WALNUT, COMPULSORY  
FOR OILY FINISH, RECOMMENDED FOR  
HAVANA AND ORIGINE FINISH

**+ 321**

CANALETTO

6 ANTE BATTENTE CON FASCIA DECORATIVA IN LEGNO  
6 HINGED DOORS WITH DECORATIVE WOODEN BAND

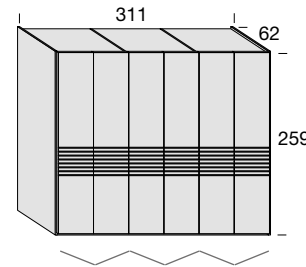

APERTURA 3 MANIGLIE IN LEGNO MASSELLO - OPENING WITH 3 SOLID WOOD HANDLES

SHN8211K	OPTIONAL			
	ACS3110K L. 100 H. 56	FASCIA BAND		
		SAHARA NOIRE KALACATTA	SILVER / GOLD / SP FUMÉ SILVER / GOLD / SMOKED M.	BICOLORE BICOLOR
<b>7.396</b>	<b>+ 470</b>	<b>+ 772</b>	<b>+ 525</b>	<b>+ 5%</b>
mc 1,45 - Kg 130	mc 0,44 - Kg 54			

### MAGGIORAZIONI E RIDUZIONI SURCHARGES AND REDUCTIONS

RIDUZIONI SINGOLE  
SINGLE ADJUSTMENTS

LUNGHEZZA LENGTH	<b>+ 30%</b>
PROFONDITÀ DEPTH	
ALTEZZA HEIGHT	

RIDUZIONI COMBinate TRA LORO  
COMBINED ADJUSTMENTS

RIDUZIONE DI 2 MISURE REDUCTION OF 2 DIMENSIONS	<b>+ 40%</b>
--	--------------

ES. RIDUZIONE IN LUNGHEZZA +  
PROFONDITÀ O PROFONDITÀ + ALTEZZA ECC.  
EX. OF REDUCTION IN LENGTH +  
DEPTH OR DEPTH + HEIGHT ETC.

RIPIANI AGGIUNTIVI SP. 3,6 CM  
ADDITIONAL SHELVES TH. 3,6 CM



TUBO APPENDIABILI  
CLOTHES HANGING RAILS



ACS1014C	ACS1013C	ACS1012C	ACS1016C	ACS1011C
L. 45	L. 70	L. 90	L. 100	L. 140
<b>136</b>	<b>162</b>	<b>186</b>	<b>229</b>	<b>241</b>
mc 0,04 - Kg 4	mc 0,05 - Kg 8	mc 0,05 - Kg 11	mc 0,06 - Kg 13	mc 0,07 - Kg 15

ACS1104C	ACS1103C	ACS1102C	ACS1106C	ACS1101C
L. 45	L. 70	L. 90	L. 100	L. 140
<b>44</b>	<b>44</b>	<b>55</b>	<b>55</b>	<b>55</b>

# NOTTE - NIGHT

## COMÒ - COMODINI

### CHEST OF DRAWERS - NIGHT TABLES

#### COMODINO SHANGHAI

#### SHANGHAI BEDSIDE TABLE

NEW

COMODINO 2 CASSETTI  
BEDSIDE TABLE WITH 2 DRAWERS

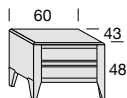

MANIGLIA INTEGRATA IN LEGNO  
INTEGRATED WOODEN HANDLE

CANALETTO	SHN7001K	OPTIONAL		
		FRONTALE - FRONT		PIANO - TOP
Bicolore / Bicolor	1.125 + 5 %	SPECCHIO FUMÉ / GOLD / SILVER SMOKED MIRROR / GOLD / SILVER	SAHARA NOIRE KALACATTA	SAHARA NOIRE KALACATTA
	mc 0,14 - Kg 40	+ 285	+ 420	+ 213

#### COMÒ SHANGHAI

#### SHANGHAI CHEST OF DRAWERS

NEW

COMÒ 3 CASSETTI  
3-DRAWER CHEST

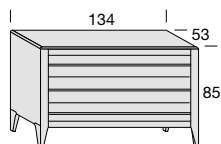

MANIGLIA INTEGRATA IN LEGNO  
INTEGRATED WOODEN HANDLE

CANALETTO	SHN6001K	OPTIONAL		
		FRONTALE - FRONT		PIANO - TOP
Bicolore / Bicolor	2.393 + 5 %	SPECCHIO FUMÉ / GOLD / SILVER SMOKED MIRROR / GOLD / SILVER	SAHARA NOIRE KALACATTA	SAHARA NOIRE KALACATTA
	mc 0,69 - Kg 70	+ 386	+ 590	+ 505

#### COMODINO DOMINO

#### DOMINO BEDSIDE TABLE

COMODINO 2 CASSETTI  
BEDSIDE TABLE WITH 2 DRAWERS

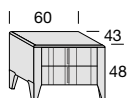

DOGA LEGNO LISCIA - MANIGLIA DOMINO  
PLAIN WOODEN SLAT - DOMINO HANDLE

CANALETTO	DON7006K	OPTIONAL		
		DOGA SLAT		
Doghe Multicolor - Multicolor slats	1.234 + 5 %	DOGA RIGHE RIBBED SLAT	DOGA QUADRO LEGNO WOODEN SQUARE SLAT	TOP MARMO MARBLE TOP
	mc 0,14 - Kg 40	+ 65	+ 104	+ 530

#### DOMINO COMÒ

#### DOMINO CHEST OF DRAWERS

COMÒ 3 CASSETTI  
3-DRAWER CHEST

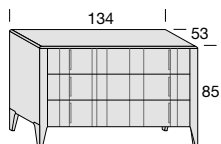

DOGA LEGNO LISCIA - MANIGLIA DOMINO  
PLAIN WOODEN SLAT - DOMINO HANDLE

CANALETTO	DON6006K	OPTIONAL		
		DOGA SLAT		
Doghe Multicolor - Multicolor slats	2.554 + 5 %	DOGA RIGHE RIBBED SLAT	DOGA QUADRO LEGNO WOODEN SQUARE SLAT	TOP MARMO MARBLE TOP
	mc 0,69 - Kg 70	+ 96	+ 133	+ 962

#### MAGGIORAZIONI E RIDUZIONI SURCHARGES AND REDUCTIONS

##### RIDUZIONI SINGOLE SINGLE ADJUSTMENTS

LUNGHEZZA LENGTH	
PROFONDITÀ DEPTH	+ 30%
ALTEZZA HEIGHT	

##### RIDUZIONI COMBinate TRA LORO COMBINED ADJUSTMENTS

LUNGHEZZA + PROFONDITÀ LENGTH + DEPTH	+ 40%
--	-------

VERSIONE  
RETROFINITA  
VERSION WITH  
FINISHED BACK

+ 10 %

PER ULTERIORI MODIFICHE  
RICHIEDERE PREVENTIVO  
FOR MODIFICATIONS  
ASK FOR AN ESTIMATE.

OPTIONAL  
(SOLO PER DOMINO  
E MEMPHIS)  
OPTIONAL  
(ONLY FOR DOMINO  
AND MEMPHIS)

TOP MARMO  
MARBLE TOP  
BIANCO CARRARA  
BIANCO CARRARA

EMPERADOR DARK  
EMPERADOR DARK



**COMÒ - COMODINI - CASSETTIERE**  
**CHEST OF DRAWERS - NIGHT TABLES - DRAWER UNITS**

**COMODINO MEMPHIS**  
**MEMPHIS BEDSIDE TABLE**

COMODINO 2 CASSETTI  
 BEDSIDE TABLE WITH 2 DRAWERS

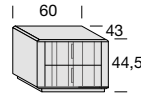

DOGA LEGNO LISCIA - MANIGLIA DOMINO  
 PLAIN WOODEN SLAT - DOMINO HANDLE

DOGA LEGNO LISCIA - MANIGLIA DOMINO	OPTIONAL
DOGA LEGNO LISCIA - MANIGLIA DOMINO	DOGA SLAT
DOGA LEGNO LISCIA - MANIGLIA DOMINO	DOGA QUADRO LEGNO
DOGA LEGNO LISCIA - MANIGLIA DOMINO	TOP MARMO
<b>DON7706K</b>	
<b>1.383</b>	
<b>+ 5 %</b>	
mc 0,14 - Kg 40	
	<b>+ 65</b>
	<b>+ 104</b>
	<b>+ 530</b>

**COMÒ MEMPHIS**  
**MEMPHIS CHEST OF DRAWERS**

COMÒ 3 CASSETTI  
 3-DRAWER CHEST

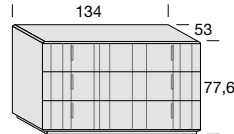

DOGA LEGNO LISCIA - MANIGLIA DOMINO  
 PLAIN WOODEN SLAT - DOMINO HANDLE

DOGA LEGNO LISCIA - MANIGLIA DOMINO	OPTIONAL
DOGA LEGNO LISCIA - MANIGLIA DOMINO	DOGA SLAT
DOGA LEGNO LISCIA - MANIGLIA DOMINO	DOGA QUADRO LEGNO
DOGA LEGNO LISCIA - MANIGLIA DOMINO	TOP MARMO
<b>DON6606K</b>	
<b>2.885</b>	
<b>+ 5 %</b>	
mc 0,69 - Kg 70	
	<b>+ 96</b>
	<b>+ 133</b>
	<b>+ 962</b>

**CASSETTIERA SHANGHAI**  
**SHANGHAI DRAWER UNIT**

**NEW**

CASSETTIERA 5 CASSETTI  
 5-DRAWER UNIT

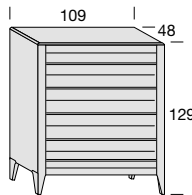

MANIGLIA INTEGRATA IN LEGNO  
 INTEGRATED WOODEN HANDLE

CASSETTIERA 5 CASSETTI	OPTIONAL
CASSETTIERA 5 CASSETTI	FRONTALE - FRONT
CASSETTIERA 5 CASSETTI	SAHARA NOIRE
CASSETTIERA 5 CASSETTI	PIANO - TOP
<b>SHN6041K</b>	
<b>3.986</b>	
<b>+ 5 %</b>	
mc 0,77 - Kg 85	
	<b>+ 691</b>
	<b>+ 775</b>
	<b>+ 264</b>

**CASSETTIERA DOMINO**  
**DOMINO DRAWER UNIT**

CASSETTIERA 5 CASSETTI  
 5-DRAWER UNIT

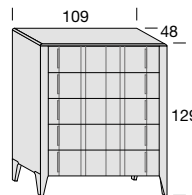

DOGA LEGNO LISCIA - MANIGLIA DOMINO  
 PLAIN WOODEN SLAT - DOMINO HANDLE

CASSETTIERA 5 CASSETTI	OPTIONAL
CASSETTIERA 5 CASSETTI	DOGA SLAT
CASSETTIERA 5 CASSETTI	DOGA QUADRO LEGNO
CASSETTIERA 5 CASSETTI	TOP MARMO
<b>DON6516K</b>	
<b>3.288</b>	
<b>+ 5 %</b>	
mc 0,77 - Kg 85	
	<b>+ 144</b>
	<b>+ 193</b>
	<b>+ 788</b>

**VANITY SHANGHAI**  
**SHANGHAI VANITY**

VANITY 1 CASSETTO E SPECCHIO  
 VANITY WITH 1 DRAWER AND MIRROR

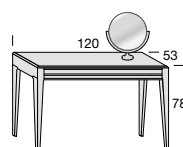

MANIGLIA INTEGRATA IN LEGNO  
 INTEGRATED WOODEN HANDLE

VANITY 1 CASSETTO E SPECCHIO	OPTIONAL
VANITY 1 CASSETTO E SPECCHIO	FRONTALE - FRONT
VANITY 1 CASSETTO E SPECCHIO	SAHARA NOIRE
VANITY 1 CASSETTO E SPECCHIO	PIANO - TOP
<b>SHN7841K</b>	
<b>2.360</b>	
<b>+ 5 %</b>	
mc 0,50 - Kg 30	
	<b>+ 285</b>
	<b>+ 420</b>
	<b>+ 213</b>

**MAGGIORAZIONI E RIDUZIONI**  
**SURCHARGES AND REDUCTIONS**

RIDUZIONI SINGOLE  
 SINGLE ADJUSTMENTS

LUNGHEZZA LENGTH	
PROFONDITÀ DEPTH	<b>+ 30%</b>
ALTEZZA HEIGHT	

RIDUZIONI COMBinate TRA LORO  
 COMBINED ADJUSTMENTS

LUNGHEZZA + PROFONDITÀ LENGTH + DEPTH	<b>+ 40%</b>
--	--------------

VERSIONE  
 RETROFINITA  
 VERSION WITH  
 FINISHED BACK

**+ 10 %**

PER ULTERIORI MODIFICHE  
 RICHIEDERE PREVENTIVO  
 FOR MODIFICATIONS  
 ASK FOR AN ESTIMATE.

**OPTIONAL**  
**(SOLO PER DOMINO**  
**E MEMPHIS)**  
**OPTIONAL**  
**(ONLY FOR DOMINO**  
**AND MEMPHIS)**

TOP MARMO  
 MARBLE TOP

BIANCO CARRARA  
 BIANCO CARRARA

EMPERADOR DARK  
 EMPERADOR DARK

## SPECCHIERE

### MIRRORS

#### SPECCHIERA SHANGHAI

##### SHANGHAI MIRROR

**NEW**

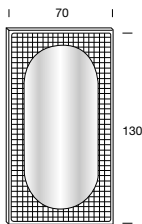

SPECCHIO ARGENTO  
SILVER MIRROR

**SHN9001K**

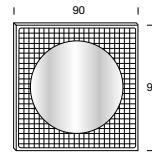

SPECCHIO ARGENTO  
SILVER MIRROR

**SHN9011K**

CANALETTO

**1.125**

mc 0,028 - Kg 38

**988**

mc 0,02 - Kg 30

#### SPECCHIERA SINGAPORE

##### SINGAPORE MIRROR

**NEW**

VERSIONE LEGNO - SPECCHIO  
WOOD - MIRROR VERSION

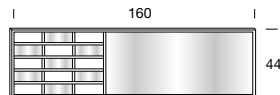

SPECCHIO ARGENTO  
SILVER MIRROR

**SHN9031K**

VERSIONE TUTTO SPECCHIO  
ALL MIRROR VERSION

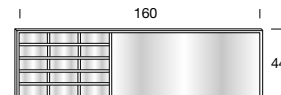

SPECCHIO ARGENTO  
SILVER MIRROR

**SHN9021K**

CANALETTO

**1.783**

mc 0,03 - Kg 35

**1.518**

mc 0,03 - Kg 35

#### SPECCHIERA THAI

##### THAI MIRROR

ORIZZONTALE / VERTICALE  
HORIZONTAL / VERTICAL

**NEW**

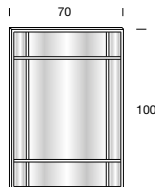

SPECCHIO ARGENTO  
SILVER MIRROR

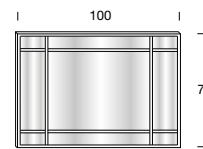

SPECCHIO ARGENTO  
SILVER MIRROR

**SHN9041K**

CANALETTO

**1.163**

mc 0,025 - Kg 25

#### SPECCHIERA DOMINO

##### DOMINO MIRROR

SPECCHIERA DOMINO  
ORIZZONTALE / VERTICALE  
HORIZONTAL / VERTICAL  
DOMINO MIRROR

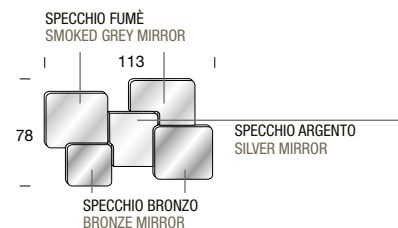

SPECCHIO FUMÈ  
SMOKED GREY MIRROR

113  
78

SPECCHIO ARGENTO  
SILVER MIRROR

SPECCHIO BRONZO  
BRONZE MIRROR

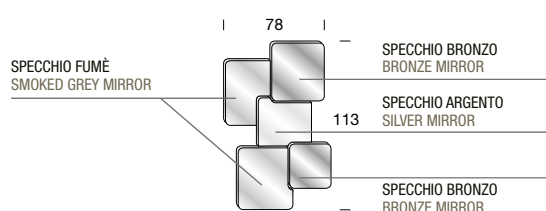

SPECCHIO FUMÈ  
SMOKED GREY MIRROR

78

113

SPECCHIO BRONZO  
BRONZE MIRROR

SPECCHIO ARGENTO  
SILVER MIRROR

SPECCHIO BRONZO  
BRONZE MIRROR

**DON9001K**

**969**

mc 0,06 - Kg 17

#### SPECCHIERA PEDRERA

##### PEDRERA MIRROR

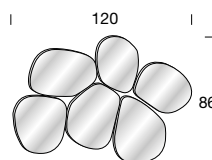

SPECCHIO ARGENTO  
SILVER MIRROR

**DON9011K**

**1.170**

mc 0,03 - Kg 17

COMPLEMENTI  
COMPLEMENTS

POLTRONA DOMINO  
DOMINO ARMCHAIR

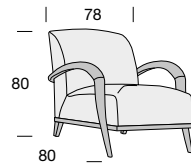

DON9101K		
CAT. A	CAT. B	CAT. C
ECOPELLE/ECONABUK ECOLEATHER/ECONABUK	LINO/VELLUTO LINEN/VELVET	PELLE LEATHER
<b>3.578</b>	<b>3.818</b>	<b>4.709</b>
mc 0,64 – Kg 45		

DON9101K		
CAT. A	CAT. B	CAT. C
ECOPELLE/ECONABUK ECOLEATHER/ECONABUK	LINO/VELLUTO LINEN/VELVET	PELLE LEATHER
<b>3.578</b>	<b>3.818</b>	<b>4.709</b>
mc 0,64 – Kg 45		

POUF DOMINO  
DOMINO POUF

MANIGLIE IN CUOIO  
LEATHER HANDLE

CML3001K		
CAT. A	CAT. B	CAT. C
ECOPELLE/ECONABUK ECOLEATHER/ECONABUK	LINO/VELLUTO LINEN/VELVET	PELLE LEATHER
<b>1.088</b>	<b>1.137</b>	<b>1.675</b>
mc 0,08 – Kg 10		

MANIGLIE IN CUOIO  
LEATHER HANDLE

CML3021K		
CAT. A	CAT. B	CAT. C
ECOPELLE/ECONABUK ECOLEATHER/ECONABUK	LINO/VELLUTO LINEN/VELVET	PELLE LEATHER
<b>1.236</b>	<b>1.298</b>	<b>1.978</b>
mc 0,12 – Kg 12		

MANIGLIE IN CUOIO  
LEATHER HANDLE

CML3011K		
CAT. A	CAT. B	CAT. C
ECOPELLE/ECONABUK ECOLEATHER/ECONABUK	LINO/VELLUTO LINEN/VELVET	PELLE LEATHER
<b>1.447</b>	<b>1.538</b>	<b>2.565</b>
mc 0,21 – Kg 14		

MANIGLIE IN CUOIO  
LEATHER HANDLE

CML3011K		
CAT. A	CAT. B	CAT. C
ECOPELLE/ECONABUK ECOLEATHER/ECONABUK	LINO/VELLUTO LINEN/VELVET	PELLE LEATHER
<b>1.447</b>	<b>1.538</b>	<b>2.565</b>
mc 0,21 – Kg 14		

PANCHETTA DOMINO  
DOMINO BENCH

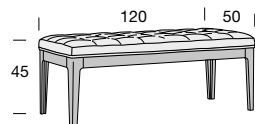

DON9081K		
CAT. A	CAT. B	CAT. C
ECOPELLE/ECONABUK ECOLEATHER/ECONABUK	LINO/VELLUTO LINEN/VELVET	PELLE LEATHER
<b>1.613</b>	<b>1.675</b>	<b>2.422</b>
mc 0,33 – Kg 15		

DON9081K		
CAT. A	CAT. B	CAT. C
ECOPELLE/ECONABUK ECOLEATHER/ECONABUK	LINO/VELLUTO LINEN/VELVET	PELLE LEATHER
<b>1.613</b>	<b>1.675</b>	<b>2.422</b>
mc 0,33 – Kg 15		

SGABELLO DOMINO  
DOMINO STOOL

NEW

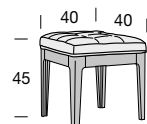

DON9181K		
CAT. A	CAT. B	CAT. C
ECOPELLE/ECONABUK ECOLEATHER/ECONABUK	LINO/VELLUTO LINEN/VELVET	PELLE LEATHER
<b>1.298</b>	<b>1.360</b>	<b>1.637</b>
mc 0,33 – Kg 015		

DON9181K		
CAT. A	CAT. B	CAT. C
ECOPELLE/ECONABUK ECOLEATHER/ECONABUK	LINO/VELLUTO LINEN/VELVET	PELLE LEATHER
<b>1.298</b>	<b>1.360</b>	<b>1.637</b>
mc 0,33 – Kg 015		

# GIORNO - DAY

## VETRINE - MADIE - CREDENZE DISPLAY UNITS - SIDEBARDS

### VETRINA SHANGHAI SHANGHAI DISPLAY UNIT

**NEW**

2 ANTE VETRO CANNETÉ, 3 RIPIANI VETRO  
2 CANNETÉ GLASS DOORS, 3 GLASS SHELVES

VETRO TRASPARENTE, MANIGLIA LEGNO  
TRANSPARENT GLASS, WOODEN HANDLE

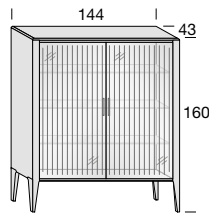

RIPIANI LEGNO AL POSTO DI VETRO  
WOODEN SHELVES INSTEAD OF GLASS SHELVES + 186

**SHG3001K**

**OPTIONAL**

BARRA LED  
LED LIGHT

PIANO - TOP  
SAHARA NOIRE  
KALACATTA

+ 433

+ 717

**CANALETTO**

**3.647**

mc 1,13 - Kg 60

### VETRINA DOMINO DOMINO DISPLAY UNIT

2 ANTE VETRO, 3 RIPIANI VETRO  
2 GLASS DOORS, 3 GLASS SHELVES

VETRO TRASPARENTE, MANIGLIA DOMINO  
TRANSPARENT GLASS, DOMINO HANDLE

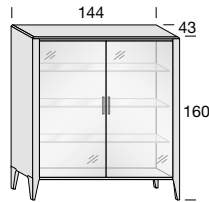

RIPIANI LEGNO AL POSTO DI VETRO  
WOODEN SHELVES INSTEAD OF GLASS SHELVES + 186

**DOG3501K**

**OPTIONAL**

BARRA LED  
LED LIGHT

FUMÉ  
SMOKED

TOP SOL  
TOP SOL

+ 433

+ 123

+ 211

**CANALETTO**

**3.145**

mc 1,13 - Kg 60

### VETRINA DOMINO DOMINO DISPLAY UNIT

2 ANTE VETRO, 2 ANTE LEGNO,  
2 RIPIANI VETRO  
2 GLASS DOORS, 2 WOODEN DOORS,  
2 GLASS SHELVES

VETRO TRASPARENTE O FUMÉ,  
DOGA LEGNO LISCIA - MANIGLIA DOMINO  
TRANSPARENT OR SMOKED GLASS,  
PLAIN WOODEN SLAT - DOMINO HANDLE

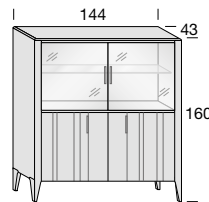

1 RIPIANO LEGNO INFERIORE AL  
POSTO DI VETRO + 74  
1 LOW WOODEN SHELF INSTEAD OF  
GLASS SHELVES

**DOG3526K**

**OPTIONAL**

BARRA LED  
LED LIGHT

VETRO GLASS  
TOP SOL  
TOP SOL

DOGA RIGHE  
RIBBED SLAT

DOGA QUADRO LEGNO  
WOODEN SQUARE SLAT

DOGA QUADRO METALLO  
METALL SQUARE SLAT

+ 371

+ 87

+ 63

+ 99

+ 384

**CANALETTO**

**4.152**

+ 5 %

mc 1,13 - Kg 60

### MADIA SHANGHAI SHANGHAI CUPBOARD

**NEW**

2 ANTE LEGNO, 3 RIPIANI VETRO  
2 WOODEN DOORS, 3 GLASS SHELVES

MANIGLIA INTEGRATA IN LEGNO  
INTEGRATED WOODEN HANDLE

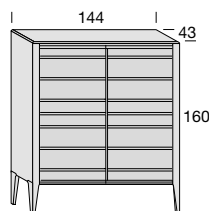

RIPIANI LEGNO AL POSTO DI VETRO  
WOODEN SHELVES INSTEAD OF GLASS SHELVES + 186

**SHG2051K**

**OPTIONAL**

SPECCHIO FUMÉ  
SMOKED MIRROR

GOLD / SILVER / SAHARA NOIRE  
KALACATTA

PIANO - TOP  
SAHARA NOIRE  
KALACATTA

2 CASSETTI INTERNI  
2 INTERNAL DRAWERS

+ 1.008

+ 1.527

+ 717

+ 606

**CANALETTO**

**3.597**

+ 5 %

mc 1,13 - Kg 60

### CREDENZA SHANGHAI SHANGHAI SIDEBARD

**NEW**

2 ANTE LEGNO, 2 RIPIANI VETRO  
2 WOODEN DOORS, 2 GLASS SHELVES

MANIGLIA INTEGRATA IN LEGNO  
INTEGRATED WOODEN HANDLE

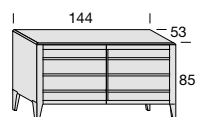

RIPIANI LEGNO AL POSTO DI VETRO  
WOODEN SHELVES INSTEAD OF GLASS SHELVES + 99

**SHG2001K**

**OPTIONAL**

SPECCHIO FUMÉ  
SMOKED MIRROR

GOLD / SILVER / SAHARA NOIRE  
KALACATTA

PIANO - TOP  
SAHARA NOIRE  
KALACATTA

2 CASSETTI INTERNI  
2 INTERNAL DRAWERS

+ 538

+ 796

+ 543

+ 606

**CANALETTO**

**2.966**

+ 5 %

mc 0,81 - Kg 65

#### MAGGIORAZIONI E RIDUZIONI SURCHARGES AND REDUCTIONS

RIDUZIONI SINGOLE  
SINGLE ADJUSTMENTS

LUNGHEZZA LENGTH	
PROFONDITÀ DEPTH	+ 30%
ALTEZZA HEIGHT	

RIDUZIONI COMBinate TRA LORO  
COMBINED ADJUSTMENTS

LUNGHEZZA + PROFONDITÀ LENGTH + DEPTH	+ 40%
--	-------

VERSIONE  
RETROFINITA  
VERSION WITH  
FINISHED BACK + 10 %

PER ULTERIORI MODIFICHE  
RICHIEDERE PREVENTIVO  
FOR MODIFICATIONS  
ASK FOR AN ESTIMATE.

**CREDENZE  
SIDEBOARDS**

**CREDENZA SHANGHAI  
SHANGHAI SIDEBOARD**

**NEW**

3 ANTE LEGNO, 3 RIPIANI VETRO  
3 WOODEN DOORS, 3 GLASS SHELVES

MANIGLIA INTEGRATA IN LEGNO  
INTEGRATED WOODEN HANDLE

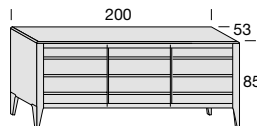

RIPIANI LEGNO AL POSTO DI VETRO  
WOODEN SHELVES INSTEAD OF GLASS SHELVES + 136

**SHG2031K**

**OPTIONAL**

**CANALETTO**

**3.584**

FRONTALE - FRONT

PIANO - TOP

Bicolore - Bicolor

+ 5 %

SPECCHIO FUMÉ  
SMOKED MIRROR

GOLD / SILVER / SAHARA NOIRE  
KALACATTA

SAHARA NOIRE  
KALACATTA

3 CASSETTI INTERNI  
3 INTERNAL DRAWERS

+ 816

+ 1.206

+ 649

+ 909

mc 1,01 - Kg 95

**CREDENZA SINGAPORE  
SINGAPORE SIDEBOARD**

**NEW**

2 ANTE LEGNO, 2 RIPIANI VETRO  
2 WOODEN DOORS, 2 GLASS SHELVES

MANIGLIA INTEGRATA IN LEGNO / PUSH PULL  
INTEGRATED WOODEN HANDLE / PUSH PULL

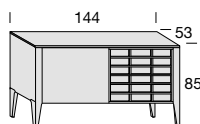

RIPIANI LEGNO AL POSTO DI VETRO  
WOODEN SHELVES INSTEAD OF GLASS SHELVES + 99

**SIG2001K**

**OPTIONAL**

**CANALETTO**

**2.966**

PIANO - TOP  
SAHARA NOIRE  
KALACATTA

2 CASSETTI INTERNI  
2 INTERNAL DRAWERS

Bicolore - Bicolor

+ 5 %

+ 507

+ 606

mc 0,81 - Kg 65

**CREDENZA SINGAPORE  
SINGAPORE SIDEBOARD**

**NEW**

3 ANTE LEGNO, 3 RIPIANI VETRO  
3 WOODEN DOORS, 3 GLASS SHELVES

MANIGLIA INTEGRATA IN LEGNO / PUSH PULL  
INTEGRATED WOODEN HANDLE / PUSH PULL

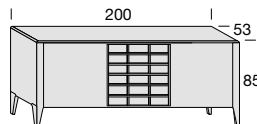

RIPIANI LEGNO AL POSTO DI VETRO  
WOODEN SHELVES INSTEAD OF GLASS SHELVES + 136

**SIG2031K**

**OPTIONAL**

**CANALETTO**

**3.584**

PIANO - TOP  
SAHARA NOIRE  
KALACATTA

3 CASSETTI INTERNI  
3 INTERNAL DRAWERS

Bicolore - Bicolor

+ 5 %

+ 755

+ 909

mc 1,01 - Kg 95

**CREDENZA DOMINO  
DOMINO SIDEBOARD**

2 ANTE LEGNO, 2 RIPIANI VETRO  
2 WOODEN DOORS, 2 GLASS SHELVES

DOGA LEGNO LISCIA - MANIGLIA DOMINO  
PLAIN WOODEN SLAT - DOMINO HANDLE

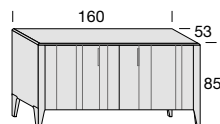

RIPIANI LEGNO AL POSTO DI VETRO  
WOODEN SHELVES INSTEAD OF GLASS SHELVES + 99

**DOG2026K**

**OPTIONAL**

**CANALETTO**

**3.442**

DOGA SLAT  
DOGA RIGHE  
RIBBED SLAT

DOGA QUADRO LEGNO  
WOOD SQUARE SLAT

DOGA QUADRO METALLO  
METAL SQUARE SLAT

PIANO - TOP  
TOP MARMO  
MARBLE TOP

2 CASSETTI INTERNI  
2 INTERNAL DRAWERS

Doghe Multicolor - Multicolor slats

+ 5 %

+ 74

+ 112

+ 408

+1.100

+ 606

mc 0,81 - Kg 65

**CREDENZA DOMINO  
DOMINO SIDEBOARD**

3 ANTE LEGNO, 3 RIPIANI VETRO  
3 WOODEN DOORS, 3 GLASS SHELVES

DOGA LEGNO LISCIA - MANIGLIA DOMINO  
PLAIN WOODEN SLAT - DOMINO HANDLE

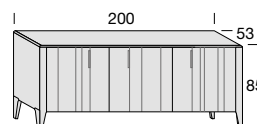

RIPIANI LEGNO AL POSTO DI VETRO  
WOODEN SHELVES INSTEAD OF GLASS SHELVES + 136

**DOG2036K**

**OPTIONAL**

**CANALETTO**

**3.999**

DOGA SLAT  
DOGA RIGHE  
RIBBED SLAT

DOGA QUADRO LEGNO  
WOOD SQUARE SLAT

DOGA QUADRO METALLO  
METAL SQUARE SLAT

PIANO - TOP  
TOP MARMO  
MARBLE TOP

3 CASSETTI INTERNI  
3 INTERNAL DRAWERS

Doghe Multicolor - Multicolor slats

+ 5 %

+ 149

+ 222

+ 668

+ 1.360

+ 909

mc 1,01 - Kg 95

**MAGGIORAZIONI E RIDUZIONI  
SURCHARGES AND REDUCTIONS**

RIDUZIONI SINGOLE  
SINGLE ADJUSTMENTS

LUNGHEZZA LENGTH	
PROFONDITÀ DEPTH	+ 30%
ALTEZZA HEIGHT	

RIDUZIONI COMBinate TRA LORO  
COMBINED ADJUSTMENTS

LUNGHEZZA + PROFONDITÀ LENGTH + DEPTH	+ 40%
--	-------

VERSIONE  
RETROFINITA  
VERSION WITH  
FINISHED BACK + 10 %

PER ULTERIORI MODIFICHE  
RICHIEDERE PREVENTIVO  
FOR MODIFICATIONS  
ASK FOR AN ESTIMATE.

**OPTIONAL  
(SOLO PER DOMINO)  
OPTIONAL  
(ONLY FOR DOMINO)**

TOP MARMO  
MARBLE TOP

BIANCO CARRARA  
BIANCO CARRARA

EMPERADOR DARK  
EMPERADOR DARK

## PORTA TV - TAVOLI TV UNITS - TABLES

### PORTA TV SHANGHAI SHANGHAI TV UNIT

**NEW**

2 ANTE LEGNO E VANO A GIORNO  
2 WOODEN DOORS AND OPEN COMPARTMENT

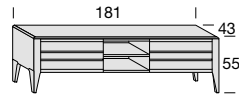

MANIGLIA INTEGRATA IN LEGNO  
INTEGRATED WOODEN HANDLE

CANALETTO	SHG5001K	OPTIONAL		
		FRONTALE - FRONT		PIANO - TOP
Bicolore - Bicolor	<b>2.966</b> + 5 %	SPECCHIO FUMÉ SMOKED MIRROR	GOLD / SILVER / SAHARA NOIRE KALACATTA	SAHARA NOIRE KALACATTA
	mc 0,49 - Kg 75	<b>+ 415</b>	<b>+ 612</b>	<b>+ 514</b>

### PORTA TV DOMINO DOMINO TV UNIT

2 ANTE LEGNO E VANO A GIORNO  
2 WOODEN DOORS AND OPEN COMPARTMENT

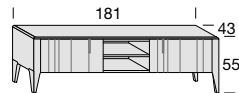

DOGA LEGNO LISCIA - MANIGLIA DOMINO  
PLAIN WOODEN SLAT - DOMINO HANDLE

CANALETTO	DOG5006K	OPTIONAL		
		DOGA SLAT		PIANO - TOP
Doghe Multicolor - Multicolor slats	<b>3.281</b> + 5 %	DOGA RIGHE RIBBED SLAT	DOGA QUADRO LEGNO WOOD SQUARE SLAT	TOP MARMO MARBLE TOP
	mc 0,49 - Kg 75	<b>+ 68</b>	<b>+ 105</b>	<b>+ 1.329</b>

### TAVOLO ALLUNGABILE SHANGHAI SHANGHAI EXTENDABLE TABLE

**NEW**

TAVOLO QUADRATO  
SQUARE TABLE

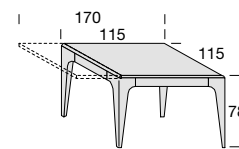

ALLUNGA DA 55  
55 CM WIDE EXTENSION

SHG4041K	OPTIONAL
	PIANO - TOP SAHARA NOIRE KALACATTA
<b>3.072</b> + 5 %	<b>+ 967</b>
mc 1,18 - Kg 40	

TAVOLO RETTANGOLARE  
RECTANGULAR TABLE

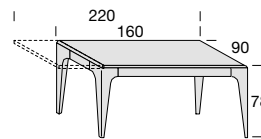

ALLUNGA DA 60  
60 CM WIDE EXTENSION

SHG4021K	OPTIONAL
	PIANO - TOP SAHARA NOIRE KALACATTA
<b>3.072</b> + 5 %	<b>+ 1.056</b>
mc 1,28 - Kg 50	

TAVOLO RETTANGOLARE  
RECTANGULAR TABLE

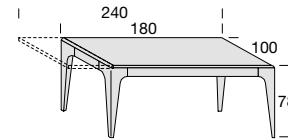

ALLUNGA DA 60  
60 CM WIDE EXTENSION

SHG4001K	OPTIONAL
	PIANO - TOP SAHARA NOIRE KALACATTA
<b>3.234</b> + 5 %	<b>+ 1.422</b>
mc 1,60 - Kg 60	

### TAVOLO ALLUNGABILE DOMINO DOMINO EXTENDABLE TABLE

TAVOLO QUADRATO  
SQUARE TABLE

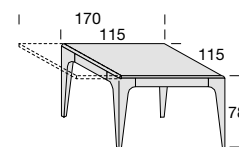

ALLUNGA DA 55  
55 CM WIDE EXTENSION

DOG4001K	OPTIONAL
	TOP MARMO MARBLE TOP
<b>3.132</b> + 5 %	<b>+ 1.050</b>
mc 1,18 - Kg 40	

TAVOLO RETTANGOLARE  
RECTANGULAR TABLE

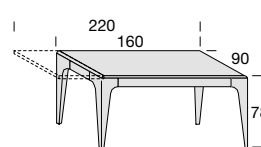

ALLUNGA DA 60  
60 CM WIDE EXTENSION

DOG4011K	OPTIONAL
	TOP MARMO MARBLE TOP
<b>3.132</b> + 5 %	<b>+ 1.145</b>
mc 1,28 - Kg 50	

TAVOLO RETTANGOLARE  
RECTANGULAR TABLE

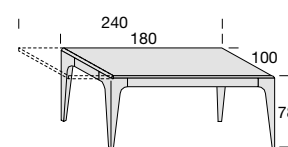

ALLUNGA DA 60  
60 CM WIDE EXTENSION

DOG4021K	OPTIONAL
	TOP MARMO MARBLE TOP
<b>3.326</b> + 5 %	<b>+ 1.534</b>
mc 1,60 - Kg 60	

#### MAGGIORAZIONI E RIDUZIONI SURCHARGES AND REDUCTIONS

RIDUZIONI SINGOLE  
SINGLE ADJUSTMENTS

LUNGHEZZA LENGTH	
PROFONDITÀ DEPTH	+ 30%
ALTEZZA HEIGHT	

RIDUZIONI COMBinate TRA LORO  
COMBINED ADJUSTMENTS

LUNGHEZZA + PROFONDITÀ LENGTH + DEPTH	+ 40%
--	-------

**OPTIONAL  
(SOLO PER DOMINO)  
OPTIONAL  
(ONLY FOR DOMINO)**

TOP MARMO  
MARBLE TOP  
BIANCO CARRARA  
BIANCO CARRARA

EMPERADOR DARK  
EMPERADOR DARK

TAVOLI  
TABLES

TAVOLI RETTANGOLARI FOSTER  
FOSTER RECTANGULAR TABLES

PIANO LEGNO  
WOODEN TOP

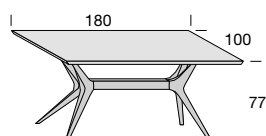

OPTIONAL: 2 ALLUNGHE DA 45 ALLOGGiate ESTERNAMENTE AL TAVOLO \*  
OPTIONAL: 2X45 CM WIDE EXTERNAL TABLE EXTENSIONS \*

DOG4081K	DOG4082K
GAMBE FAGGIO BEECH LEGS	GAMBE CANALETTO CANALETTO LEGS
<b>2.610</b>	<b>3.335</b>

mc 1,58 – Kg 55

PIANO EFFETTO MARMO  
MARBLE EFFECT TOP

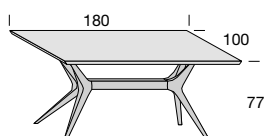

OPTIONAL: 2 ALLUNGHE DA 45 ALLOGGiate ESTERNAMENTE AL TAVOLO \*  
OPTIONAL: 2X45 CM WIDE EXTERNAL TABLE EXTENSIONS \*

DOG4601K	DOG4602K
GAMBE FAGGIO BEECH LEGS	GAMBE CANALETTO CANALETTO LEGS
<b>4.270</b>	<b>4.995</b>

mc 1,58 – Kg 75

PIANO VETRO  
GLASS TOP

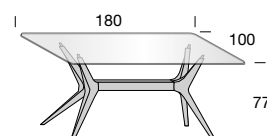

VETRO TRASPARENTE O FUMÉ  
TRANSPARENT OR SMOKED GLASS

DOG4091K	DOG4092K
GAMBE FAGGIO BEECH LEGS	GAMBE CANALETTO CANALETTO LEGS
<b>2.780</b>	<b>3.505</b>

mc 1,58 – Kg 75

PER ESSENZA FAGGIO NON POSSIBILE LA FINITURA OLIO E SCONSIGLIATA FINITURA HAVANA E ORIGINE  
OIL FINISH IS NOT POSSIBLE DUE TO BEECH ESSENCE AND HAVANA FINISHES AND ORIGINE ARE NOT RECOMMENDED

CANALETTO

MAGGIORAZIONI E RIDUZIONI  
RICHIEDERE PREVENTIVO  
SURCHARGES AND REDUCTIONS  
PRICE ON REQUEST

\* PREZZO PER DUE  
ALLUNGHE DA 45 CM.  
\* PRICE FOR TWO  
EXTENSION OF 45 CM.

**+ 702**

TAVOLI RETTANGOLARI FOSTER  
FOSTER RECTANGULAR TABLES

PIANO LEGNO  
WOODEN TOP

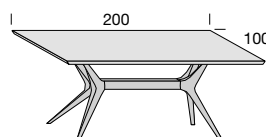

OPTIONAL: 2 ALLUNGHE DA 45 ALLOGGiate ESTERNAMENTE AL TAVOLO \*  
OPTIONAL: 2X45 CM WIDE EXTERNAL TABLE EXTENSIONS \*

DOG4041K	DOG4042K
GAMBE FAGGIO BEECH LEGS	GAMBE CANALETTO CANALETTO LEGS
<b>2.710</b>	<b>3.435</b>

mc 1,76 – Kg 65

PIANO EFFETTO MARMO  
MARBLE EFFECT TOP

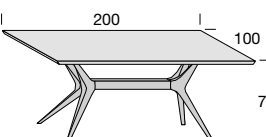

OPTIONAL: 2 ALLUNGHE DA 45 ALLOGGiate ESTERNAMENTE AL TAVOLO \*  
OPTIONAL: 2X45 CM WIDE EXTERNAL TABLE EXTENSIONS \*

DOG4611K	DOG4612K
GAMBE FAGGIO BEECH LEGS	GAMBE CANALETTO CANALETTO LEGS
<b>4.365</b>	<b>5.090</b>

mc 1,76 – Kg 82

PIANO VETRO  
GLASS TOP

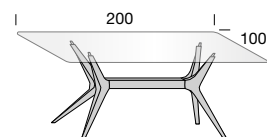

VETRO TRASPARENTE O FUMÉ  
TRANSPARENT OR SMOKED GLASS

DOG4071K	DOG4072K
GAMBE FAGGIO BEECH LEGS	GAMBE CANALETTO CANALETTO LEGS
<b>2.870</b>	<b>3.595</b>

mc 1,76 – Kg 82

PER ESSENZA FAGGIO NON POSSIBILE LA FINITURA OLIO E SCONSIGLIATA FINITURA HAVANA E ORIGINE  
OIL FINISH IS NOT POSSIBLE DUE TO BEECH ESSENCE AND HAVANA FINISHES AND ORIGINE ARE NOT RECOMMENDED

CANALETTO

TAVOLI RETTANGOLARI NORMAN  
NORMAN RECTANGULAR TABLES

PIANO VETRO EFFETTO MARMO  
MARBLE EFFECT GLASS TOP

**NEW**

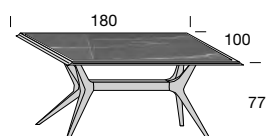

VETRO SAHARA NOIRE O KALACATTA  
SAHARA NOIRE OR KALACATTA GLASS

DOG4301K	DOG4302K
GAMBE FAGGIO BEECH LEGS	GAMBE CANALETTO CANALETTO LEGS
<b>4.950</b>	<b>5.616</b>

mc 1,60 – Kg 75

PIANO VETRO EFFETTO MARMO  
MARBLE EFFECT GLASS TOP

**NEW**

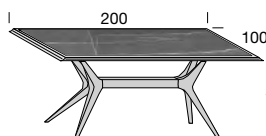

VETRO SAHARA NOIRE O KALACATTA  
SAHARA NOIRE OR KALACATTA GLASS

DOG4311K	DOG4312K
GAMBE FAGGIO BEECH LEGS	GAMBE CANALETTO CANALETTO LEGS
<b>5.045</b>	<b>5.980</b>

mc 1,80 – Kg 82

PER ESSENZA FAGGIO NON POSSIBILE LA FINITURA OLIO E SCONSIGLIATA FINITURA HAVANA E ORIGINE  
OIL FINISH IS NOT POSSIBLE DUE TO BEECH ESSENCE AND HAVANA FINISHES AND ORIGINE ARE NOT RECOMMENDED

CANALETTO

TAVOLI ROTONDI FOSTER  
FOSTER ROUND TABLES

PIANO LEGNO  
WOODEN TOP

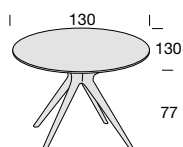

DOG4331K	DOG4332K
GAMBE FAGGIO BEECH LEGS	GAMBE CANALETTO CANALETTO LEGS
<b>2.505</b>	<b>3.115</b>

mc 1,48 – Kg 40

PIANO EFFETTO MARMO  
MARBLE EFFECT TOP

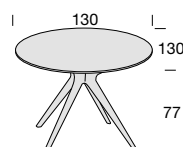

DOG4621K	DOG4622K
GAMBE FAGGIO BEECH LEGS	GAMBE CANALETTO CANALETTO LEGS
<b>4.160</b>	<b>4.770</b>

mc 1,48 – Kg 56

PIANO VETRO  
GLASS TOP

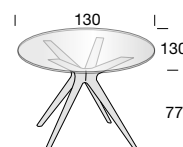

VETRO TRASPARENTE O FUMÉ  
TRANSPARENT OR SMOKED GLASS

DOG4431K	DOG4432K
GAMBE FAGGIO BEECH LEGS	GAMBE CANALETTO CANALETTO LEGS
<b>2.740</b>	<b>3.350</b>

mc 1,48 – Kg 56

PER ESSENZA FAGGIO NON POSSIBILE LA FINITURA OLIO E SCONSIGLIATA FINITURA HAVANA E ORIGINE  
OIL FINISH IS NOT POSSIBLE DUE TO BEECH ESSENCE AND HAVANA FINISHES AND ORIGINE ARE NOT RECOMMENDED

CANALETTO

OPTIONAL  
OPTIONAL

LAZY SUSAN SPECCHIO  
LACCATO NERO  
MIRROR BLACK  
LACQUERED LAZY SUSAN

**+ 674**

## TAVOLI ROTONDI FOSTER FOSTER ROUND TABLES

PIANO LEGNO  
WOODEN TOP

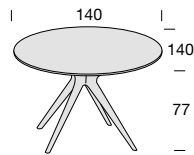

PIANO EFFETTO MARMO  
MARBLE EFFECT TOP

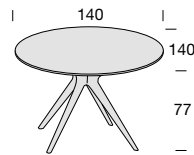

PIANO VETRO  
GLASS TOP

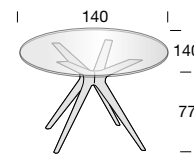

VETRO TRASPARENTE O FUMÉ  
TRANSPARENT OR SMOKED GLASS

PER ESSENZA FAGGIO NON POSSIBILE LA  
FINITURA OLIO E SCONSIGLIATA FINITURA  
HAVANA E ORIGINE  
OIL FINISH IS NOT POSSIBLE DUE TO BEECH  
ESSENCE AND HAVANA FINISHES AND ORIGINE  
ARE NOT RECOMMENDED

DOG4031K	DOG4032K
GAMBE FAGGIO BEECH LEGS	GAMBE CANALETTO CANALETTO LEGS
<b>2.745</b>	<b>3.355</b>

DOG4631K	DOG4632K
GAMBE FAGGIO BEECH LEGS	GAMBE CANALETTO CANALETTO LEGS
<b>4.405</b>	<b>5.015</b>

DOG4231K	DOG4232K
GAMBE FAGGIO BEECH LEGS	GAMBE CANALETTO CANALETTO LEGS
<b>2.875</b>	<b>3.485</b>

CANALETTO

mc 1,55 – Kg 40

mc 1,55 – Kg 62

mc 1,55 – Kg 62

## TAVOLI ROTONDI FOSTER FOSTER ROUND TABLES

PIANO LEGNO  
WOODEN TOP

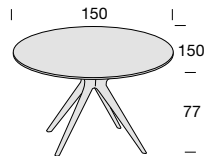

PIANO EFFETTO MARMO  
MARBLE EFFECT TOP

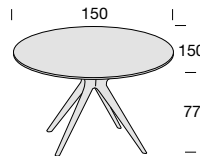

PIANO VETRO  
GLASS TOP

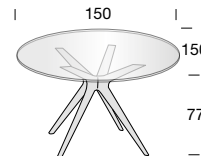

VETRO TRASPARENTE O FUMÉ  
TRANSPARENT OR SMOKED GLASS

PER ESSENZA FAGGIO NON POSSIBILE LA  
FINITURA OLIO E SCONSIGLIATA FINITURA  
HAVANA E ORIGINE  
OIL FINISH IS NOT POSSIBLE DUE TO BEECH  
ESSENCE AND HAVANA FINISHES AND ORIGINE  
ARE NOT RECOMMENDED

DOG4061K	DOG4062K
GAMBE FAGGIO BEECH LEGS	GAMBE CANALETTO CANALETTO LEGS
<b>2.870</b>	<b>3.480</b>

DOG4641K	DOG4642K
GAMBE FAGGIO BEECH LEGS	GAMBE CANALETTO CANALETTO LEGS
<b>4.530</b>	<b>5.140</b>

DOG4261K	DOG4262K
GAMBE FAGGIO BEECH LEGS	GAMBE CANALETTO CANALETTO LEGS
<b>3.025</b>	<b>3.635</b>

CANALETTO

mc 1,60 – Kg 45

mc 1,60 – Kg 70

mc 1,60 – Kg 70

## TAVOLI ROTONDI FOSTER FOSTER ROUND TABLES

PIANO LEGNO  
WOODEN TOP

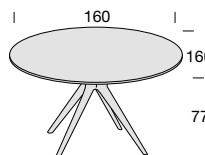

PIANO EFFETTO MARMO  
MARBLE EFFECT TOP

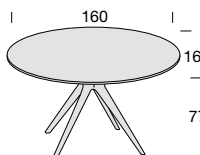

PIANO VETRO  
GLASS TOP

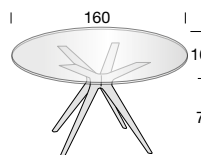

VETRO TRASPARENTE O FUMÉ  
TRANSPARENT OR SMOKED GLASS

PER ESSENZA FAGGIO NON POSSIBILE LA  
FINITURA OLIO E SCONSIGLIATA FINITURA  
HAVANA E ORIGINE  
OIL FINISH IS NOT POSSIBLE DUE TO BEECH  
ESSENCE AND HAVANA FINISHES AND ORIGINE  
ARE NOT RECOMMENDED

DOG4111K	DOG4112K
GAMBE FAGGIO BEECH LEGS	GAMBE CANALETTO CANALETTO LEGS
<b>2.970</b>	<b>3.580</b>

DOG4651K	DOG4652K
GAMBE FAGGIO BEECH LEGS	GAMBE CANALETTO CANALETTO LEGS
<b>4.630</b>	<b>5.240</b>

DOG4211K	DOG4212K
GAMBE FAGGIO BEECH LEGS	GAMBE CANALETTO CANALETTO LEGS
<b>3.185</b>	<b>3.795</b>

CANALETTO

mc 1,70 – Kg 50

mc 1,70 – Kg 78

mc 1,70 – Kg 78

## TAVOLINI SHANGHAI SHANGHAI SMALL TABLES

NEW

TAVOLINO QUADRATO  
SQUARE TABLE

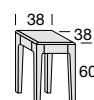

TAVOLINO QUADRATO  
SQUARE TABLE

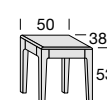
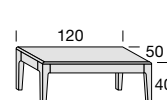
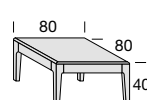

SHG6001K	OPTIONAL
	PIANO - TOP SAHARA NOIRE KALACATTA
<b>784</b>	
mc 0,10 Kg 8	<b>+ 437</b>

SHG6011K	OPTIONAL
	PIANO - TOP SAHARA NOIRE KALACATTA
<b>1.180</b>	
mc 0,29 Kg 15	<b>+ 1.062</b>

SHG6021K	OPTIONAL
	PIANO - TOP SAHARA NOIRE KALACATTA
<b>1.180</b>	
mc 0,27 Kg 15	<b>+ 1.109</b>

SHG3301K	OPTIONAL
	PIANO - TOP SAHARA NOIRE KALACATTA
<b>784</b>	
mc 0,12 Kg 10	<b>+ 437</b>

CANALETTO



TAVOLINI - CONSOLLE - SCRITTOIO  
SMALL TABLES - CONSOLE - WRITING DESK

TAVOLINI DOMINO  
DOMINO SMALL TABLES

TAVOLINO QUADRATO  
SQUARE TABLE

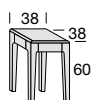

<b>DOG6811K</b>	<b>OPTIONAL</b>
	PIANO - TOP TOP MARMO MARBLE TOP
<b>832</b>	<b>+ 466</b>
mc 0,10 – Kg 8	

TAVOLINO QUADRATO  
SQUARE TABLE

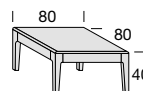

<b>DOG6801K</b>	<b>OPTIONAL</b>
	PIANO - TOP TOP MARMO MARBLE TOP
<b>1.221</b>	<b>+ 1.127</b>
mc 0,29 – Kg 15	

<b>CANALETTO</b>

TAVOLINO RETTANGOLARE  
RECTANGULAR TABLE

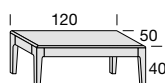

<b>DOG6821K</b>	<b>OPTIONAL</b>
	PIANO - TOP TOP MARMO MARBLE TOP
<b>1.345</b>	<b>+ 1.180</b>
mc 0,27 – Kg 15	

TAVOLINO RETTANGOLARE  
RECTANGULAR TABLE

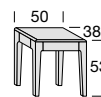

<b>DON3301K</b>	<b>OPTIONAL</b>
	PIANO - TOP TOP MARMO MARBLE TOP
<b>832</b>	<b>+ 466</b>
mc 0,12 – Kg 10	

<b>CANALETTO</b>

CONSOLLE DOMINO  
DOMINO CONSOLE

1 CASSETTO  
1 DRAWER

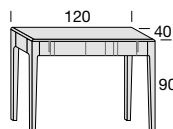

DOGA LEGNO LISCIA - MANIGLIA DOMINO  
PLAIN WOODEN SLAT - DOMINO HANDLE

<b>DOG5806K</b>	<b>OPTIONAL</b>			
	DOGA SLAT DOGA RIGHE RIBBED SLAT	PIANO - TOP TOP MARMO MARBLE TOP		
<b>1.872</b>	<b>+ 44</b>	<b>+ 865</b>		
mc 0,50 – Kg 40				

<b>CANALETTO</b>
Doghe Multicolor - Multicolor slats

SCRITTOIO DOMINO  
DA PARETE  
WALL WRITING  
DESK DOMINO

1 CASSETTO  
1-DRAWER

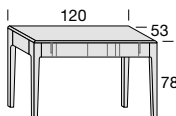

DOGA LEGNO LISCIA, MANIGLIA DOMINO  
PLAIN WOODEN SLAT, DOMINO HANDLE

<b>DOG5906K</b>	<b>OPTIONAL</b>			
	DOGA SLAT DOGA RIGHE RIBBED SLAT	TOP MARMO MARBLE TOP	PIANO - TOP TOP PELLE LEATHER TOP	SPECCHIO MIRROR
<b>1.947</b>	<b>+ 44</b>	<b>+ 927</b>	<b>+ 711</b>	<b>+ 635</b>
mc 0,57 – Kg 45				

<b>CANALETTO</b>
Doghe Multicolor - Multicolor slats

SCRITTOIO DOMINO  
BIFACCIALE  
DOUBLE-SIDED WRITING  
DESK DOMINO

1 CASSETTO  
1-DRAWER

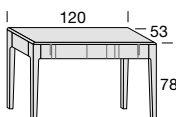

DOGA LEGNO LISCIA, MANIGLIA DOMINO  
PLAIN WOODEN SLAT, DOMINO HANDLE

<b>DOG5916K</b>	<b>OPTIONAL</b>			
	DOGA SLAT DOGA RIGHE RIBBED SLAT	TOP MARMO MARBLE TOP	PIANO - TOP TOP PELLE LEATHER TOP	SPECCHIO MIRROR
<b>2.534</b>	<b>+ 87</b>	<b>+ 1.052</b>	<b>+ 699</b>	<b>+ 635</b>
mc 0,57 – Kg 45				

<b>CANALETTO</b>
Doghe Multicolor - Multicolor slats

MAGGIORAZIONI E RIDUZIONI  
SURCHARGES AND REDUCTIONS

RIDUZIONI SINGOLE  
SINGLE ADJUSTMENTS

LUNGHEZZA LENGTH	
PROFONDITÀ DEPTH	<b>+ 30%</b>
ALTEZZA HEIGHT	

RIDUZIONI COMBinate TRA LORO  
COMBINED ADJUSTMENTS

LUNGHEZZA + PROFONDITÀ LENGTH + DEPTH	<b>+ 40%</b>
--	--------------

PER ULTERIORI MODIFICHE  
RICHIEDERE PREVENTIVO  
FOR MODIFICATIONS  
ASK FOR AN ESTIMATE.

OPTIONAL  
OPTIONAL

TOP MARMO  
MARBLE TOP

BIANCO CARRARA  
BIANCO CARRARA



EMPERADOR DARK  
EMPERADOR DARK



NEW

# GIORNO - DAY

## SCRIVANIE - POLTRONE - DIVANI

### DESKS - ARMCHAIRS - SOFAS

#### SCRIVANIA DOMINO

##### DOMINO DESK

**NEW**

VERSIONE DRITTA 4 CASSETTI CON PIANO IN PELLE  
STRAIGHT VERSION DESK WITH 4 DRAWERS, LEATHER TOP

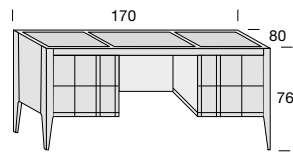

DOGA LEGNO LISCIA, MANIGLIA DOMINO  
PLAIN WOODEN SLAT, DOMINO HANDLE

DOG4511K	OPTIONAL	
	MULTIPRESA MULTIPLE SOCKET	RICARICA WIRELESS WIRELESS CHARGING
<b>7.354</b>		
<b>+ 10%</b>	<b>+ 755</b>	<b>+ 384</b>
mc 1,30 - Kg 115		

VERSIONE CURVA 4 CASSETTI CON PIANO IN PELLE  
CURVED VERSION DESK WITH 4 DRAWERS, LEATHER TOP

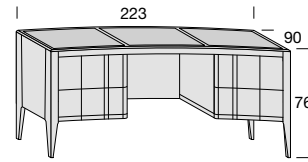

DOGA LEGNO LISCIA, MANIGLIA DOMINO  
PLAIN WOODEN SLAT, DOMINO HANDLE

DOG4501K	OPTIONAL	
	MULTIPRESA MULTIPLE SOCKET	RICARICA WIRELESS WIRELESS CHARGING
<b>9.757</b>		
<b>+ 10%</b>	<b>+ 755</b>	<b>+ 384</b>
mc 2,44 - Kg 143		

#### CANALETTO

Doghe Multicolor - Multicolor slats

#### POLTRONA GOTHAM GOTHAM ARMCHAIR

**NEW**

IMBOTTITA GIREVOLE  
PADDED SWIVEL

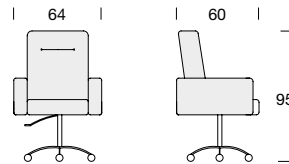

BASAMENTO METALLO IN FINITURA NICKEL O BRONZO  
METAL BASE IN NICKEL OR BRONZE FINISH

CML1942K		
CAT. A	CAT. B	CAT. C
ECOPELLE/ECONABUK ECOLEATHER/ECONABUK	LINO/VELLUTO LINEN/VELVET	PELLE LEATHER
<b>3.008</b>	<b>3.103</b>	<b>4.660</b>
mc 0,44 - Kg 30		

#### POLTRONA BUDDY BUDDY ARMCHAIR

**NEW**

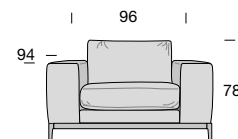

BASE IN LEGNO  
WOODEN BASE

MOG9011K		
ECOPELLE/ECONABUK ECOLEATHER/ECONABUK	LINO/VELLUTO LINEN/VELVET	PELLE LEATHER
<b>3.481</b>	<b>3.922</b>	<b>6.842</b>
<b>+ 732</b>		
mc 0,80 - Kg 45		

MAGGIORAZIONE PER BASAMENTO IN NOCE  
CANALETTO OBBLIGATORIO PER FINITURA A  
OLIO, CONSIGLIATO PER FINITURA HAVANA E  
ORIGINE

INCREASE FOR WALNUT BASE  
COMPULSORY CANALETTO FOR OIL FINISH,  
AND RECOMMENDED FOR HAVANA AND  
ORIGINE FINISHES

#### FAGGIO / BEECH

Basamento canaletto - Canaletto base

#### DIVANI BUDDY BUDDY SOFAS

**NEW**

2 POSTI  
2 SEAT

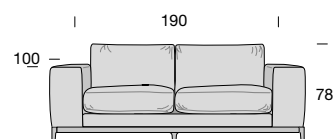

BASE IN LEGNO  
WOODEN BASE

MOG9021K		
ECOPELLE/ECONABUK ECOLEATHER/ECONABUK	LINO/VELLUTO LINEN/VELVET	PELLE LEATHER
<b>5.526</b>	<b>5.875</b>	<b>8.795</b>
<b>+ 1.004</b>		
mc 1,80 - Kg 85		

3 POSTI  
3 SEAT

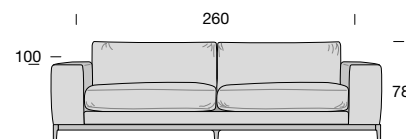

BASE IN LEGNO  
WOODEN BASE

MOG9031K		
ECOPELLE/ECONABUK ECOLEATHER/ECONABUK	LINO/VELLUTO LINEN/VELVET	PELLE LEATHER
<b>6.276</b>	<b>6.630</b>	<b>9.545</b>
<b>+ 1.226</b>		
mc 2,45 - Kg 95		

MAGGIORAZIONE PER BASAMENTO IN NOCE  
CANALETTO OBBLIGATORIO PER FINITURA A  
OLIO, CONSIGLIATO PER FINITURA HAVANA E  
ORIGINE

INCREASE FOR WALNUT BASE  
COMPULSORY CANALETTO FOR OIL FINISH,  
AND RECOMMENDED FOR HAVANA AND  
ORIGINE FINISHES

#### FAGGIO / BEECH

Basamento canaletto - Canaletto base

# SEDIE CHAIRS

## SEDIA SHANGHAI SEDILE E SCHIENALE IMBOTTITO

### SHANGHAI CHAIR UPHOLSTERED BACK PANEL AND SEAT

**NEW**

ESSENZA FUSTO CANALETTO  
CARCASE IN CANALETTO WALNUT WOOD RANGE

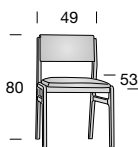

SENZA BRACCIOLI  
WITHOUT ARMREST

SHG1012K		
CAT. A	CAT. B	CAT. C
ECOPELLE/ECONABUK ECOLEATHER/ECONABUK	LINO/VELLUTO LINEN/VELVET	PELLE LEATHER
<b>1.145</b>	<b>1.268</b>	<b>1.805</b>

mc 0,25 – Kg 13

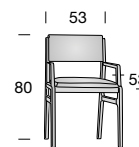

CON BRACCIOLI  
WITH ARMREST

SHG1022K		
CAT. A	CAT. B	CAT. C
ECOPELLE/ECONABUK ECOLEATHER/ECONABUK	LINO/VELLUTO LINEN/VELVET	PELLE LEATHER
<b>1.203</b>	<b>1.327</b>	<b>1.869</b>

mc 0,26 – Kg 14

## SEDIA DOMINO SEDILE E SCHIENALE IMBOTTITO

### DOMINO CHAIR UPHOLSTERED BACK PANEL AND SEAT

PER ESSENZA FAGGIO NON POSSIBILE LA  
FINITURA OLIO

OIL FINISH IS NOT POSSIBLE FOR BEECH  
ESSENCE

ESSENZA FUSTO FAGGIO  
CARCASE IN BEECH WOOD RANGE

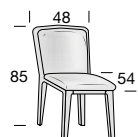

DOG1011K		
CAT. A	CAT. B	CAT. C
ECOPELLE/ECONABUK ECOLEATHER/ECONABUK	LINO/VELLUTO LINEN/VELVET	PELLE LEATHER
<b>725</b>	<b>780</b>	<b>910</b>

mc 0,25 – Kg 15

## SEDIA BARCELONA SEDILE E SCHIENALE IMBOTTITO

### BARCELONA CHAIR UPHOLSTERED BACK PANEL AND SEAT

PER ESSENZA FAGGIO NON POSSIBILE LA  
FINITURA OLIO

OIL FINISH IS NOT POSSIBLE FOR BEECH  
ESSENCE

ESSENZA FUSTO FAGGIO  
CARCASE IN BEECH WOOD RANGE

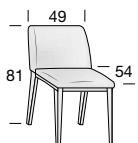

DOG1021K		
CAT. A	CAT. B	CAT. C
ECOPELLE/ECONABUK ECOLEATHER/ECONABUK	LINO/VELLUTO LINEN/VELVET	PELLE LEATHER
<b>580</b>	<b>630</b>	<b>725</b>

mc 0,24 – Kg 15

## COMPOSIZIONI A CATALOGO CATALOGUE COMPOSITIONS

PAG. 148-149 CATALOGO "DESIGN"  
PAGE 148-149 "DESIGN" CATALOGUE

1	<b>DON5211K</b>	LETTO PEDRERA DA 160 CON GIROLETTO LEGNO 160 CM WIDE PEDRERA BED WITH WOODEN BED SURROUND	<b>5.253</b>
2	<b>SHN7001K</b>	COMODINO SHANGHAI 2 CASSETTI SHANGHAI BEDSIDE TABLE	<b>2.250</b>
1	<b>SHN6001K</b>	COMO SHANGHAI 3 CASSETTI SHANGHAI 3-DRAWER CHEST	<b>2.393</b>
<b>PREZZO TOT. COMPOSIZIONE</b> TOTAL PRICE FOR COMPOSITION			<b>9.896</b>



PAG. 152-153 CATALOGO "DESIGN"  
PAGE 152-153 "DESIGN" CATALOGUE

1	<b>DON5211K</b>	LETTO PEDRERA DA 160 CON GIROLETTO LEGNO 160 CM WIDE PEDRERA BED WITH WOODEN BED SURROUND	<b>5.253</b>
2	<b>DON7006K</b>	COMODINO DOMINO 2 CASSETTI DOGA LEGNO LISCIA DOMINO BEDSIDE TABLE WITH 2 DRAWERS PLAIN WOODEN SLAT	<b>2.468</b>
<b>PREZZO TOT. COMPOSIZIONE</b> TOTAL PRICE FOR COMPOSITION			<b>7.721</b>



PAG. 156-157 CATALOGO "DESIGN"  
PAGE 156-157 "DESIGN" CATALOGUE

1	<b>DON5211K</b>	LETTO PEDRERA DA 160 CON GIROLETTO LEGNO 160 CM WIDE PEDRERA BED WITH WOODEN BED SURROUND	<b>5.253</b>
2	<b>DON7006K</b>	COMODINO DOMINO 2 CASSETTI DOGA RIGHE - MULTICOLOR DOMINO BEDSIDE TABLE WITH 2 DRAWERS RIBBEDS SLAT - MULTICOLOR	<b>2.722</b>
<b>PREZZO TOT. COMPOSIZIONE</b> TOTAL PRICE FOR COMPOSITION			<b>7.975</b>

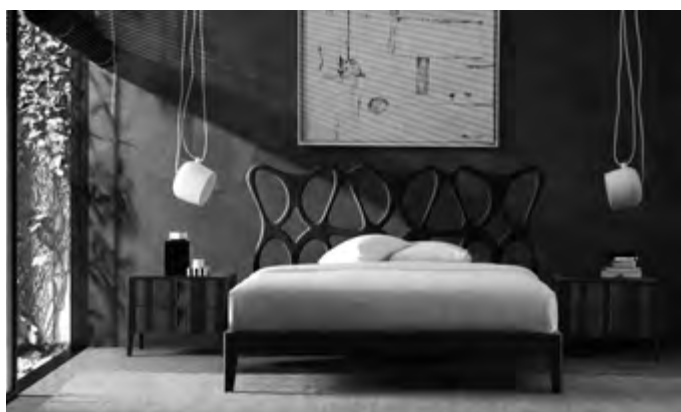

PAG. 162-163 CATALOGO "DESIGN"  
PAGE 162-163 "DESIGN" CATALOGUE

1	<b>SHN5301K</b>	LETTO ALBA DA 160 CON GIROLETTO LEGNO, TESTATA RIVESTITA IN PELLE (CAT. C) 160 CM WIDE ALBA BED WITH WOODEN BED SURROUND, PADDED HEADBOARD IN LEATHER (CAT. C)	<b>4.910</b>
2	<b>SHN7001K</b>	COMODINO SHANGHAI 2 CASSETTI SHANGHAI BEDSIDE TABLE	<b>2.250</b>
1	<b>SHN6041K</b>	CASSETTIERA SHANGHAI 5 CASSETTI SHANGHAI 5-DRAWER UNIT	<b>3.986</b>
1	<b>DON9081K</b>	PANCHETTA DOMINO IN PELLE (CAT. C) DOMINO BENCH PADDED IN LEATHER (CAT. C)	<b>2.422</b>
<b>PREZZO TOT. COMPOSIZIONE</b> TOTAL PRICE FOR COMPOSITION			<b>13.568</b>



## COMPOSIZIONI A CATALOGO CATALOGUE COMPOSITIONS

PAG. 172-173 CATALOGO "DESIGN"  
PAGE 172-173 "DESIGN" CATALOGUE

1	<b>SHN5301K</b>	LETTO ALBA DA 160 CON GIROLETTO LEGNO, TESTATA RIVESTITA IN ECOPELLE (CAT. A) 160 CM WIDE ALBA BED WITH WOODEN BED SURROUND, PADDED HEADBOARD IN ECO-LEATHER (CAT. A)	<b>3.375</b>
2	<b>DON7006K</b>	COMODINO DOMINO 2 CASSETTI DOGA RIGHE DOMINO BEDSIDE TABLE WITH 2 DRAWERS RIBBED SLAT	<b>2.598</b>
<b>PREZZO TOT. COMPOSIZIONE</b> TOTAL PRICE FOR COMPOSITION			<b>5.973</b>



PAG. 176-177 CATALOGO "DESIGN"  
PAGE 176-177 "DESIGN" CATALOGUE

1	<b>DON5721K</b>	LETTO BUTTERFLY DA 160 CON GIROLETTO LEGNO E FASCIA IMBOTTITA RIVESTIMENTO ECONABUK CAT. A 160 CM WIDE BUTTERFLY BED WITH WOODEN BED SURROUND AND UPHOLSTERED STRIP WITH ECONABUK COVER CAT. A	<b>3.263</b>
2	<b>DON7006K</b>	COMODINO DOMINO 2 CASSETTI DOGA RIGHE DOMINO BEDSIDE TABLE WITH 2 DRAWERS STRIPED SLAT	<b>2.598</b>
<b>PREZZO TOT. COMPOSIZIONE</b> TOTAL PRICE FOR COMPOSITION			<b>5.861</b>



PAG. 180-181 CATALOGO "DESIGN"  
PAGE 180-181 "DESIGN" CATALOGUE

1	<b>DON5701K</b>	LETTO BUTTERFLY DA 160 CON GIROLETTO LEGNO, RIVESTIMENTO ECONABUK CAT. A 160 CM WIDE BUTTERFLY BED WITH WOODEN BED SURROUND, ECONABUK COVER CAT. A	<b>2.830</b>
2	<b>DON7006K</b>	COMODINO DOMINO 2 CASSETTI DOGA LEGNO LISCIA DOMINO BEDSIDE TABLE WITH 2 DRAWERS PLAIN WOODEN SLAT	<b>2.468</b>
1	<b>DON6006K</b>	COMO DOMINO 3 CASSETTI DOGA LEGNO LISCIA DOMINO 3-DRAWER CHEST PLAIN WOODEN SLAT	<b>2.554</b>
<b>PREZZO TOT. COMPOSIZIONE</b> TOTAL PRICE FOR COMPOSITION			<b>7.852</b>

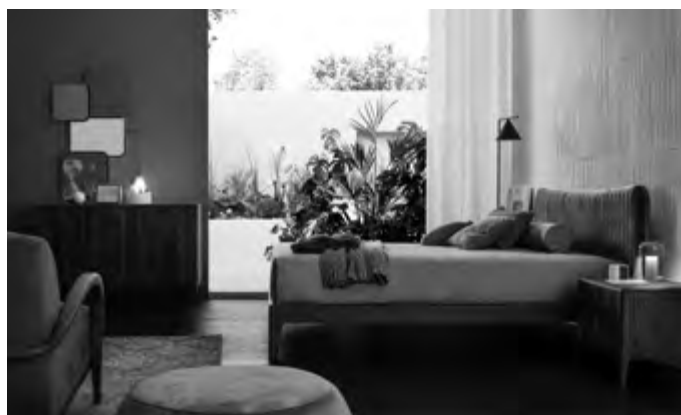

PAG. 186-187 CATALOGO "DESIGN"  
PAGE 186-187 "DESIGN" CATALOGUE

1	<b>DON5301K</b>	LETTO SHANGHAI DA 160 CON GIROLETTO LEGNO, TESTATA RIVESTIMENTO IN ECONABUK (CAT. A) 160 CM WIDE SHANGHAI BED WITH WOODEN BED SURROUND, PADDED HEADBOARD IN ECONABUK (CAT. A)	<b>3.139</b>
2	<b>SHN7001K</b>	COMODINO SHANGHAI 2 CASSETTI SHANGHAI BEDSIDE TABLE	<b>2.250</b>
1	<b>SHN6001K</b>	COMO SHANGHAI 3 CASSETTI SHANGHAI 3-DRAWER CHEST	<b>2.393</b>
1	<b>SHN9011K</b>	SPECCHIERA SHANGHAI SHANGHAI MIRROR	<b>988</b>
<b>PREZZO TOT. COMPOSIZIONE</b> TOTAL PRICE FOR COMPOSITION			<b>8.770</b>



## COMPOSIZIONI A CATALOGO

### CATALOGUE COMPOSITIONS

PAG. 192-193 CATALOGO "DESIGN"  
PAGE 192-193 "DESIGN" CATALOGUE

1	<b>DON5506K</b>	LETTO DOMINO DA 160 TESTIERA IMBOTTITA A DOGHE E DOGA LEGNO LISCIA, GIROLETTO LEGNO RIVESTIMENTO LINO CAT. B - MULTICOLOR 160 CM WIDE DOMINO BED WITH SLATTED UPHOLSTERED HEADBOARD AND PLAIN WOODEN SLAT, WOODEN BED SURROUND WITH LINEN COVER CAT. B - MULTICOLOR	<b>3.024</b>
2	<b>DON7706K</b>	COMODINO MEMPHIS 2 CASSETTI DOGA LEGNO LISCIA MEMPHIS BEDSIDE TABLE WITH 2 DRAWERS PLAIN WOODEN SLAT	<b>2.766</b>
<b>PREZZO TOT. COMPOSIZIONE</b> TOTAL PRICE FOR COMPOSITION			<b>5.790</b>



PAG. 200-201 CATALOGO "DESIGN"  
PAGE 200-201 "DESIGN" CATALOGUE

1	<b>DON5902K</b>	LETTO RAINBOW DA 160 H. 115 CON 2 CUSCINI BARRE, GIROLETTO LEGNO, RIVESTIMENTO ECOPELLE CAT. A 160 CM WIDE-H. 115 RAINBOW BED WITH 2 RIBBED CUSHION, WOODEN BED SURROUND, ECOLEATHER COVER CAT. A	<b>3.350</b>
2	<b>SHN7001K</b>	COMODINO SHANGHAI FRONTALE "GOLD" SHANGHAI BEDSIDE TABLE WITH "GOLD" FRONT	<b>2.820</b>
1	<b>SHN6001K</b>	COMO SHANGHAI FRONTALE "GOLD" SHANGHAI CHEST OF DRAWERS WITH "GOLD" FRONT	<b>2.779</b>
<b>PREZZO TOT. COMPOSIZIONE</b> TOTAL PRICE FOR COMPOSITION			<b>8.949</b>



PAG. 204-205 CATALOGO "DESIGN"  
PAGE 204-205 "DESIGN" CATALOGUE

1	<b>DON5912K</b>	LETTO RAINBOW DA 160 H 115 2 CUSCINI BARRE, GIROLETTO LEGNO CON FASCIA IMBOTTITA RIVESTIMENTO ECOPELLE CAT. A 160 CM WIDE 115 RAINBOW BED WITH 2 RIBBED CUSHION, WOODEN BED SURROUND WITH UPHOLSTERED STRIP WITH ECOLEATHER COVER CAT. A	<b>3.720</b>
2	<b>DON7006K</b>	COMODINO DOMINO 2 CASSETTI TOP MARMO, DOGA LEGNO LISCIA DOMINO BEDSIDE TABLE WITH 2 DRAWERS MARBLE TOP, PLAIN WOODEN SLAT	<b>3.528</b>
<b>PREZZO TOT. COMPOSIZIONE</b> TOTAL PRICE FOR COMPOSITION			<b>7.248</b>



PAG. 210-211 CATALOGO "DESIGN"  
PAGE 210-211 "DESIGN" CATALOGUE

1	<b>DON5121K</b>	LETTO RAINBOW DA 160 H 90, GIROLETTO IMBOTTITO CON CONTENITORE RIVESTIMENTO ECONABUK CAT. A - MULTICOLOR 160 CM WIDE RAINBOW STORAGE BED H 90, UPHOLSTERED BED SURROUND WITH ECONABUK COVER CAT. A - MULTICOLOR	<b>3.758</b>
1	<b>DON3301K</b>	TAVOLINO DA NOTTE DOMINO DOMINO BEDSIDE TABLE	<b>832</b>
1	<b>DON7006K</b>	COMODINO DOMINO 2 CASSETTI DOGA RIGHE DOMINO BEDSIDE TABLE WITH 2 DRAWERS RIBBED SLAT	<b>1.299</b>
1	<b>DON6516K</b>	CASSETTIERA DOMINO 5 CASSETTI DOGA RIGHE DOMINO 5-DRAWER UNIT RIBBED SLAT	<b>3.432</b>
<b>PREZZO TOT. COMPOSIZIONE</b> TOTAL PRICE FOR COMPOSITION			<b>9.321</b>



## COMPOSIZIONI A CATALOGO CATALOGUE COMPOSITIONS

PAG. 216-217 CATALOGO "DESIGN"  
PAGE 216-217 "DESIGN" CATALOGUE

1	<b>DON5011K</b>	LETTO TOBIA DA 160 TESTIERA IMBOTTITA, GIROLETTO LEGNO RIVESTIMENTO ECONABUK CAT. A 160 CM WIDE TOBIA BED WITH UPHOLSTERED HEADBOARD, WOODEN BED SURROUND, ECONABUK COVER CAT. A	<b>3.350</b>
2	<b>DON7006K</b>	COMODINO DOMINO 2 CASSETTI DOGA LEGNO LISCIA DOMINO BEDSIDE TABLE WITH 2 DRAWERS PLAIN WOODEN SLAT	<b>2.468</b>
1	<b>DON6516K</b>	CASSETTIERA DOMINO 5 CASSETTI DOGA LEGNO LISCIA DOMINO 5-DRAWER UNIT PLAIN WOODEN SLAT	<b>3.288</b>
<b>PREZZO TOT. COMPOSIZIONE</b> TOTAL PRICE FOR COMPOSITION			<b>10.106</b>



PAG. 224-225 CATALOGO "DESIGN"  
PAGE 224-225 "DESIGN" CATALOGUE

1	<b>DON5411K</b>	LETTO BATTLO DA 160 TESTIERA IMBOTTITA, GIROLETTO LEGNO RIVESTIMENTO LINO CAT. B 160 CM WIDE BATTLO BED WITH UPHOLSTERED HEADBOARD, WOODEN BED SURROUND WITH LINEN COVER CAT. B	<b>2.892</b>
2	<b>DON7006K</b>	COMODINO DOMINO 2 CASSETTI DOGA LEGNO LISCIA DOMINO BEDSIDE TABLE WITH 2 DRAWERS PLAIN WOODEN SLAT	<b>2.468</b>
<b>PREZZO TOT. COMPOSIZIONE</b> TOTAL PRICE FOR COMPOSITION			<b>5.360</b>



PAG. 14-15 CATALOGO "DESIGN"  
PAGE 14-15 "DESIGN" CATALOGUE

1	<b>SIG2031K</b>	CREDENZA SINGAPORE 3 ANTE - BICOLORE SINGAPORE 3-DOOR SIDEBOARD - BICOLOR	<b>3.763</b>
1	<b>SHN9031K</b>	SPECCHIERA SINGAPORE SINGAPORE MIRROR	<b>1.783</b>
<b>PREZZO TOT. COMPOSIZIONE</b> TOTAL PRICE FOR COMPOSITION			<b>5.546</b>



PAG. 22-23 CATALOGO "DESIGN"  
PAGE 22-23 "DESIGN" CATALOGUE

1	<b>SHG2031K</b>	CREDENZA SHANGHAI 3 ANTE CON TOP SAHARA NOIRE SHANGHAI 3 DOOR SIDEBOARD WITH SAHARA NOIRE TOP	<b>4.233</b>
1	<b>DON9001K</b>	SPECCHIERA DOMINO DOMINO MIRROR	<b>969</b>
<b>PREZZO TOT. COMPOSIZIONE</b> TOTAL PRICE FOR COMPOSITION			<b>5.202</b>



## COMPOSIZIONI A CATALOGO CATALOGUE COMPOSITIONS

PAG. 32-33 CATALOGO "DESIGN"  
PAGE 32-33 "DESIGN" CATALOGUE

1	<b>SHG2031K</b>	CREDENZA SHANGHAI 3 ANTE SHANGHAI 3 DOOR SIDEBOARD	<b>3.584</b>
1	<b>SHG4001K</b>	TAVOLO SHANGHAI 180 X 100 PIANO IN LEGNO ALLUNGABILE - BICOLOR SHANGHAI EXTENDING TABLE WITH WOODEN TOP 180 X 100 - BICOLOR	<b>3.396</b>
4	<b>DOG1021K</b>	SEDIA BARCELONA, RIVESTIMENTO ECONABUK (CAT A) BARCELONA CHAIR, ECONABUK COVER CAT. A	<b>2.320</b>
<b>PREZZO TOT. COMPOSIZIONE</b> TOTAL PRICE FOR COMPOSITION			<b>9.300</b>

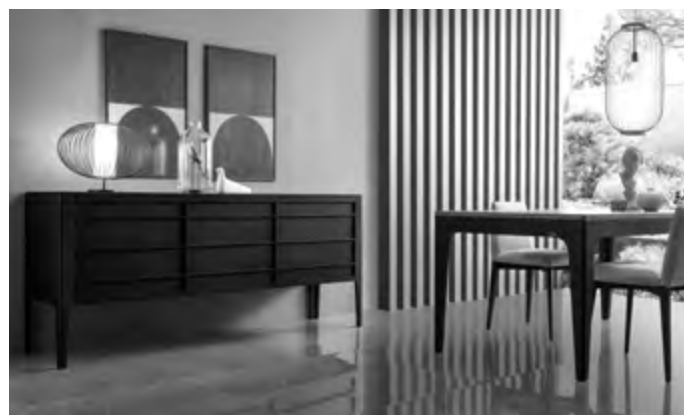

PAG. 40-41 CATALOGO "DESIGN"  
PAGE 40-41 "DESIGN" CATALOGUE

1	<b>SHG2031K</b>	CREDENZA SHANGHAI 3 ANTE, FRONTALI SPECCHIO FUMÉ SHANGHAI 3 DOOR SIDEBOARD, SMOKED MIRROR FRONTS	<b>4.400</b>
1	<b>DOG4091K</b>	TAVOLO FOSTER 180 X 100 PIANO VETRO TRASPARENTE, GAMBE FAGGIO FOSTER 180 X 100 TABLE, GLASS TRANSPARENT TOP, BEECH LEGS	<b>2.780</b>
4	<b>DOG1021K</b>	SEDIA BARCELONA, RIVESTIMENTO VELLUTO (CAT B) BARCELONA CHAIR, VELVET COVER CAT. B	<b>2.520</b>
<b>PREZZO TOT. COMPOSIZIONE</b> TOTAL PRICE FOR COMPOSITION			<b>9.700</b>



PAG. 54-55 CATALOGO "DESIGN"  
PAGE 54-55 "DESIGN" CATALOGUE

2	<b>SHG2051K</b>	MADIA SHANGHAI 2 ANTE LEGNO SHANGHAI 2 WOODEN DOOR DISPLAY UNIT	<b>7.194</b>
<b>PREZZO TOT. COMPOSIZIONE</b> TOTAL PRICE FOR COMPOSITION			<b>7.194</b>



PAG. 58-59 CATALOGO "DESIGN"  
PAGE 58-59 "DESIGN" CATALOGUE

2	<b>SHG3001K</b>	VETRINA SHANGHAI, ANTE VETRO CANNETÉ SHANGHAI DISPLAY UNIT, CANNETÉ GLASS DOORS	<b>7.294</b>
<b>PREZZO TOT. COMPOSIZIONE</b> TOTAL PRICE FOR COMPOSITION			<b>7.294</b>





## COMPOSIZIONI A CATALOGO CATALOGUE COMPOSITIONS

PAG. 64-65 CATALOGO "DESIGN"  
PAGE 64-65 "DESIGN" CATALOGUE

2	<b>DOG3526K</b>	VETRINA DOMINO 2 ANTE VETRO FUMÉ 2 ANTE LEGNO DOGA RIGHE DOMINO DISPLAY UNIT WITH 2 SMOKED GLASS DOORS 2 WOODEN DOORS STRIPED SLAT	<b>8.604</b>
1	<b>DOG4081K</b>	TAVOLO FOSTER PIANO LEGNO GAMBE FAGGIO 180 X 100 FOSTER TABLE WITH WOODEN TOP, BEECH LEGS 180 X 100	<b>2.610</b>
4	<b>DOG1011K</b>	SEDIA DOMINO RIVESTIMENTO ECONABUK CAT. A DOMINO CHAIR WITH ECONABUK COVER CAT. A	<b>2.900</b>
<b>PREZZO TOT. COMPOSIZIONE</b> TOTAL PRICE FOR COMPOSITION			<b>14.114</b>



PAG. 88-89 CATALOGO "DESIGN"  
PAGE 88-89 "DESIGN" CATALOGUE

1	<b>DOG3526K</b>	VETRINA DOMINO 2 ANTE VETRO TRASPARENTE, 2 ANTE LEGNO DOGA LEGNO LISCIA - MULTICOLOR DOMINO DISPLAY UNIT WITH 2 TRANSPARENT GLASS DOORS, 2 WOODEN DOORS PLAIN WOODEN SLAT - MULTICOLOR	<b>4.360</b>
1	<b>DOG4081K</b>	TAVOLO FOSTER 180 x100 PIANO LEGNO, GAMBE FAGGIO FOSTER TABLE WITH WOODEN TOP, BEECH LEGS 180 x 100	<b>2.610</b>
4	<b>DOG1021K</b>	SEDIA BARCELONA RIVESTIMENTO ECONABUK CAT. A BARCELONA CHAIR WITH ECONABUK COVER CAT. A	<b>2.320</b>
<b>PREZZO TOT. COMPOSIZIONE</b> TOTAL PRICE FOR COMPOSITION			<b>9.290</b>



PAG. 96-97 CATALOGO "DESIGN"  
PAGE 96-97 "DESIGN" CATALOGUE

1	<b>DOG4231K</b>	TAVOLO FOSTER Ø 140, PIANO VETRO FUMÉ, GAMBE FAGGIO FOSTER TABLE Ø 140, SMOKED GLASS TOP, BEECH LEGS	<b>2.875</b>
4	<b>SHG1012K</b>	SEDIA SHANGHAI, RIVESTIMENTO CAT. A SHANGHAI CHAIR, UPHOLSTERY CAT. A	<b>4.580</b>
<b>PREZZO TOT. COMPOSIZIONE</b> TOTAL PRICE FOR COMPOSITION			<b>7.455</b>



PAG. 101 CATALOGO "DESIGN"  
PAGE 101 "DESIGN" CATALOGUE

1	<b>DOG4091K</b>	TAVOLO FOSTER 180X100 PIANO VETRO TRASPARENTE, GAMBE FAGGIO FOSTER TABLE 180X100 TRANSPARENT GLASS TOP, BEECH LEGS 180 X 100	<b>2.780</b>
4	<b>DOG1012K</b>	SEDIA DOMINO RIVESTIMENTO ECONABUK CAT. A DOMINO CHAIR, UPHOLSTERY ECONABUK CAT. A	<b>2.900</b>
<b>PREZZO TOT. COMPOSIZIONE</b> TOTAL PRICE FOR COMPOSITION			<b>5.680</b>



## COMPOSIZIONI A CATALOGO CATALOGUE COMPOSITIONS

PAG. 104-105 CATALOGO "DESIGN"  
PAGE 104-105 "DESIGN" CATALOGUE

1	<b>DOG4311K</b>	TAVOLO NORMAN 200 x 100 PIANO SAHARA NOIRE, GAMBE FAGGIO NORMAN TABLE, SAHARA NOIRE TOP, BEECH LEGS 200 x 100	<b>5.045</b>
1	<b>SHG2031K</b>	CREDENZA SHANGHAI 3 ANTE, PIANO SAHARA NOIRE SHANGHAI 3 DOOR SIDEBOARD, SAHARA NOIRE TOP	<b>4.233</b>
4	<b>SHG1022K</b>	SEDIA SHANGHAI CON BRACCIOLI, RIVESTIMENTO CAT. A SHANGHAI CHAIR WITH ARMRESTS, UPHOLSTERY CAT. A	<b>4.812</b>
<b>PREZZO TOT. COMPOSIZIONE</b> TOTAL PRICE FOR COMPOSITION			<b>14.090</b>



PAG. 110-111 CATALOGO "DESIGN"  
PAGE 110-111 "DESIGN" CATALOGUE

1		COMPONIBILE DOMINO COMPOSIZIONE 40 DOMINO MODULAR SYSTEM COMPOSITION 40	<b>5.643</b>
1	<b>DOG4011K</b>	TAVOLO DOMINO 160 x 90 PIANO LEGNO ALLUNGABILE DOMINO EXTENDING TABLE WITH WOODEN TOP 160 x 90	<b>3.132</b>
4	<b>DOG1021K</b>	SEDIA BARCELONA RIVESTIMENTO ECONABUK CAT. A BARCELONA CHAIRS WITH ECONABUK COVER CAT. A	<b>2.320</b>
<b>PREZZO TOT. COMPOSIZIONE DOGA LEGNO LISCIA</b> TOTAL PRICE FOR COMPOSITION PLAIN WOODEN SLAT			<b>11.095</b>

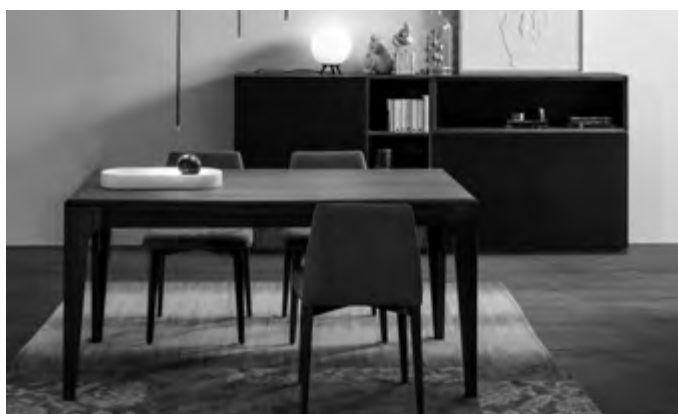

PAG. 116-117 CATALOGO "DESIGN"  
PAGE 116-117 "DESIGN" CATALOGUE

1	<b>DOG4501K</b>	SCRIVANIA CURVA DOMINO MULTICOLOR 223 X 90 CON 4 CASSETTI E PIANO IN PELLE DOMINO MULTICOLOR CURVED DESK 223 X 90, WITH 4 DRAWERS AND LEATHER TOP	<b>10.245</b>
1	<b>CML1942K</b>	POLTRONA GIREVOLE GOTHAM, RIVESTIMENTO PELLE (CAT. C) GOTHAM SWIVEL ARMCHAIR, LEATHER COVER (CAT. C)	<b>4.660</b>
<b>PREZZO TOT. COMPOSIZIONE</b> TOTAL PRICE FOR COMPOSITION			<b>14.905</b>



# SISTEMA COMPONIBILE

## MODULAR SYSTEM

CARATTERISTICHE TECNICHE E PARTICOLARITÀ DI UTILIZZO TECHNICAL CHARACTERISTICS AND PARTICULAR USE	58
ACCESSORI OPTIONAL OPTIONAL ACCESSORIES	67
ELEMENTI STRUTTURALI STRUCTURAL ELEMENTS	68
BASI A TERRA P. 38 FLOOR-STANDING BASE UNITS D. 38	72
BASI A TERRA P. 48 FLOOR-STANDING BASE UNITS D. 48	74
BASI SOSEPE P. 38 SUSPENDED BASE UNITS D. 38	78
BASI SOSEPE P. 48 SUSPENDED BASE UNITS D. 48	80
PENSILI ORIZZONTALI P. 38 HORIZONTAL WALL UNITS D. 38	82
PENSILI VERTICALI P. 38 VERTICAL WALL UNITS D. 38	88
COLONNE A GIORNO P. 30 RAISED TALL UNITS P. 30	92
COMPOSIZIONI A CATALOGO CATALOGUE COMPOSITIONS	94

# SISTEMA COMPONIBILE - MODULAR SYSTEM

## CARATTERISTICHE TECNICHE E PARTICOLARITÀ DI UTILIZZO

### TECHNICAL CHARACTERISTICS AND PARTICULAR USE

#### BASI

#### BASE UNITS

#### FRONTALI

#### FRONTS

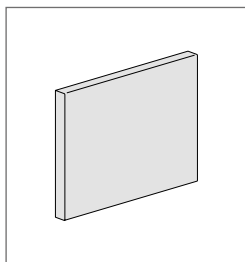

ANTA LEGNO LISCIA  
PLAIN WOODEN DOOR

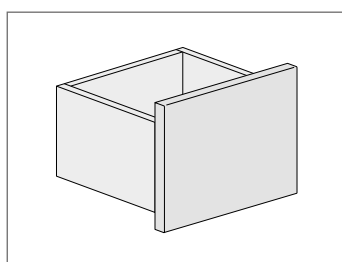

FRONTALE LEGNO LISCIO  
PLAIN WOODEN FRONT

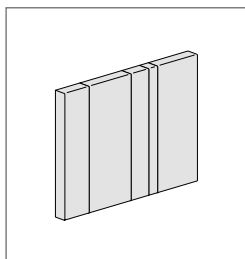

DOGA LEGNO LISCIA  
PLAIN WOODEN SLAT

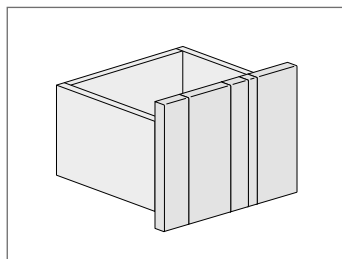

DOGA LEGNO LISCIA  
PLAIN WOODEN SLAT

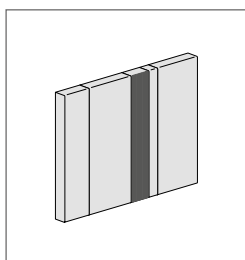

DOGA RIGHE  
STRIPED SLAT

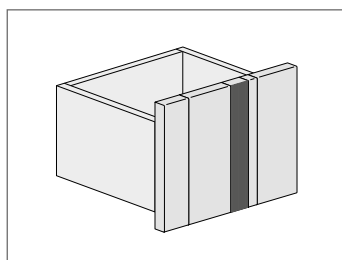

DOGA RIGHE  
STRIPED SLAT

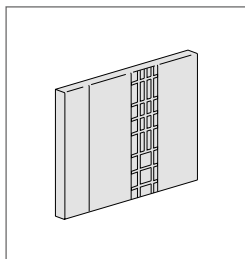

DOGA QUADRO LEGNO  
WOODEN SQUARE SLAT

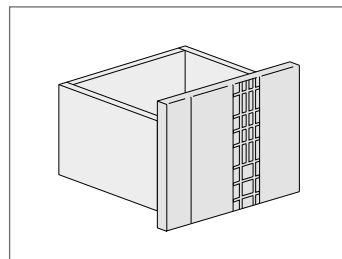

DOGA QUADRO LEGNO  
WOODEN SQUARE SLAT

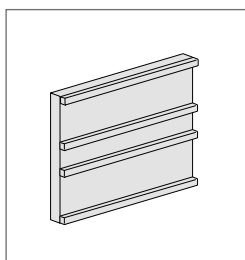

ANTA LEGNO SHANGHAI  
SHANGHAI WOODEN DOOR

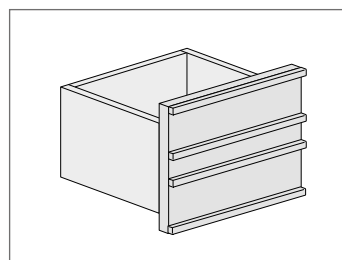

FRONTALE LEGNO SHANGHAI  
SHANGHAI WOODEN FRONT

#### STRUTTURA

PANNELLO DI LISTELLARE ESTERNO RIVESTITO IN NOCE CANALETTO, INTERNO ANTA LEGNO, ANTA VETRO E CESTONI RIVESTITO IN NOCE TANGANICA, INTERNO MODULI A GIORNO RIVESTITO IN NOCE CANALETTO

#### TOP OBBLIGATORIO

PANNELLO DI LEGNO MULTISTRATI IMPIALLACCIATO NOCE CANALETTO SP. 1.1

#### FRONTALE LEGNO PANNELLO LISCIO

PANNELLO DI LISTELLARE IMPIALLACCIATA INTERNAMENTE IN NOCE CANALETTO ED ESTERNAMENTE IN NOCE CANALETTO SP. 3 CM

#### FRONTALE LEGNO A DOGHE

PANNELLO DI LISTELLARE IMPIALLACCIATA INTERNAMENTE IN NOCE CANALETTO ED ESTERNAMENTE IN NOCE TANGANICA SP. 2.9 CM, CON DOGHE IN MULTISTRATI IMPIALLACCIATO NOCE CANALETTO E LATI IN MASSELLO DI NOCE CANALETTO SP. 0.3 CM

#### SCHIENALE

INTERNO ANTE LEGNO E VETRO IN MULTISTRATI NOCE TANGANICA SPESSORE 0.8 CM

#### ZOCCOLO

PANNELLO DI LISTELLARE IMPIALLACCIATO IN NOCE CANALETTO E RETRO IN NOCE TANGANICA SPESSORE 4 CM.

#### PEDANA

PANNELLO DI LISTELLARE IMPIALLACCIATO IN NOCE CANALETTO E RETRO IN NOCE TANGANICA SPESSORE 4 CM – PIEDINI IN PANNELLO NOCE CANALETTO 2 FACCE SPESSORE 4 CM.

#### RIPIANI INTERNI

VETRO SP. 0.8

#### ELEMENTI A GIORNO

PANNELLO DI LISTELLARE IMPIALLACCIATA INTERNAMENTE ED ESTERNAMENTE IN NOCE CANALETTO SPESSORE 1.8 CM

#### SCHIENALE ELEMENTI A GIORNO

PANNELLO DI MULTISTRATI DI NOCE CANALETTO SPESSORE 0.8 CM

#### STRUCTURE

BLOCKBOARD PANEL: OUTSIDE COVERED IN CANALETTO WALNUT, INSIDE OF WOODEN DOOR, GLASS DOOR AND BASKETS COVERED IN TANGANICA WALNUT, INSIDE OF OPEN MODULES COVERED IN CANALETTO WALNUT

#### COMPUSLORY TOP

MULTILAYER WOODEN PANEL VENEERED IN CANALETTO WALNUT TH. 1.1

#### PLAIN PANEL WOODEN FRONT

BLOCKBOARD PANEL: INSIDE VENEERED IN CANALETTO WALNUT AND OUTSIDE IN CANALETTO WALNUT TH. 3 CM

#### SLATTED WOODEN FRONT

BLOCKBOARD PANEL: INSIDE VENEERED IN CANALETTO WALNUT AND OUTSIDE IN TANGANICA WALNUT TH. 2.9 CM, WITH MULTILAYER SLAT VENEERED IN CANALETTO WALNUT AND SIDES IN SOLID CANALETTO WALNUT TH. 0.3 CM

#### BACK PANEL

INSIDE OF WOODEN AND GLASS DOORS IN MULTILAYER TANGANICA WALNUT TH. 0.8 CM

#### PLINTH

BLOCKBOARD PANEL: VENEERED IN CANALETTO WALNUT AND BACK IN TANGANICA WALNUT TH. 4 CM

BLOCKBOARD PANEL: VENEERED IN CANALETTO WALNUT AND BACK IN TANGANICA WALNUT TH. 4 CM – FEET IN CANALETTO WALNUT PANEL 2 SIDES TH. 4 CM.

#### INTERNAL SHELVES

GLASS TH. 0.8

#### OPEN ELEMENTS

BLOCKBOARD PANEL: INSIDE VENEERED AND OUTSIDE IN CANALETTO WALNUT TH. 1.8 CM

#### BACK PANEL FOR OPEN ELEMENT

MULTILAYER PANEL IN CANALETTO WALNUT TH. 0.8 CM

#### MANIGLIE HANDLES

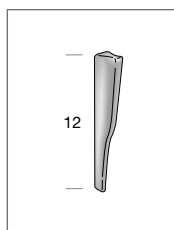

MANIGLIA PICCOLA  
SMALL HANDLE

## CARATTERISTICHE TECNICHE E PARTICOLARITÀ DI UTILIZZO TECHNICAL CHARACTERISTICS AND PARTICULAR USE

### PENSILI WALL UNITS

#### FRONTALI FRONTS

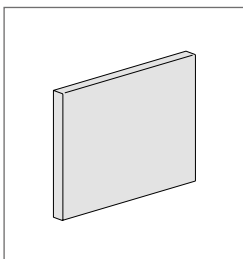

ANTA LEGNO LISCIA  
PLAIN WOODEN DOOR

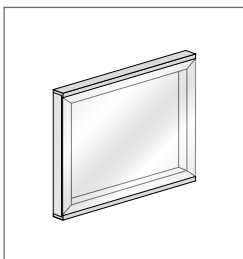

ANTA VETRO  
GLASS DOOR

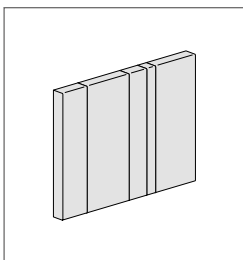

DOGA LEGNO LISCIA  
PLAIN WOODEN SLAT

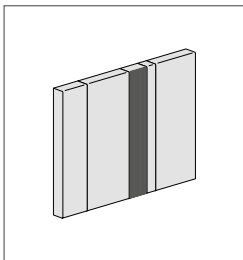

DOGA RIGHE  
STRIPED SLAT

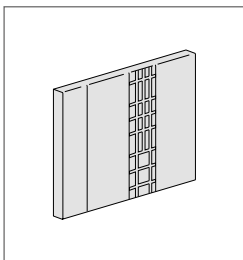

DOGA QUADRO LEGNO  
WOODEN SQUARE SLAT

**STRUTTURA** PANNELLO DI LISTELLARE ESTERNO RIVESTITO IN NOCE CANALETTO, INTERNO ANTA LEGNO, ANTA VETRO E CESTONI RIVESTITO IN NOCE TANGANICA, INTERNO MODULI A GIORNO RIVESTITO IN NOCE CANALETTO

**TOP OPZIONALE** PANNELLO DI LEGNO MULTISTRATI IMPIALLACCIATO NOCE CANALETTO SP. 1.3

**FRONTALE LEGNO PANNELLO LISCIO** PANNELLO DI LISTELLARE IMPIALLACCIATA INTERNAMENTE IN NOCE CANALETTO ED ESTERNAMENTE IN NOCE CANALETTO SP. 3 CM

**FRONTALE LEGNO A DOGHE** PANNELLO DI LISTELLARE IMPIALLACCIATA INTERNAMENTE IN NOCE CANALETTO ED ESTERNAMENTE IN NOCE TANGANICA SP. 2.9 CM, CON DOGHE IN MULTISTRATI IMPIALLACCIATO NOCE CANALETTO E LATI IN MASSELLO DI NOCE CANALETTO SP. 0.3 CM

**FRONTALE VETRO** TELAIO IN PANNELLO DI LISTELLARE IMPIALLACCIATA INTERNAMENTE IN NOCE CANALETTO ED ESTERNAMENTE IN NOCE CANALETTO, PROFILO SUPERIORE E INFERIORE IN MASSELLO DI NOCE CANALETTO 5X2.5 CM

**SCHIENALE** INTERNO ANTE LEGNO E VETRO IN MULTISTRATI NOCE TANGANICA SPESSORE 0.8 CM

**RIPIANI INTERNI** VETRO SP. 0.8

**ELEMENTI A GIORNO** PANNELLO DI LISTELLARE IMPIALLACCIATA INTERNAMENTE ED ESTERNAMENTE IN NOCE CANALETTO SPESSORE 1.8 CM

**SCHIENALE ELEMENTI A GIORNO** PANNELLO DI MULTISTRATI DI NOCE CANALETTO SPESSORE 0.8 CM

**STRUCTURE** BLOCKBOARD PANEL: OUTSIDE COVERED IN CANALETTO WALNUT, INSIDE OF WOODEN DOOR, GLASS DOOR AND BASKETS COVERED IN TANGANICA WALNUT, INSIDE OF OPEN MODULES COVERED IN CANALETTO WALNUT

**OPTIONAL TOP** MULTILAYER WOODEN PANEL VENEERED IN CANALETTO WALNUT TH. 1.3

**PLAIN PANEL WOODEN FRONT** BLOCKBOARD PANEL: INSIDE VENEERED IN CANALETTO WALNUT AND OUTSIDE IN CANALETTO WALNUT TH. 3 CM

**SLATTED WOODEN FRONT** BLOCKBOARD PANEL: INSIDE VENEERED IN CANALETTO WALNUT AND OUTSIDE IN TANGANICA WALNUT TH. 2.9 CM, WITH MULTILAYER SLAT VENEERED IN CANALETTO WALNUT AND SIDES IN SOLID CANALETTO WALNUT TH. 0.3 CM

**GLASS FRONT** FRAME IN BLOCKBOARD PANEL VENEERED INSIDE IN CANALETTO WALNUT AND OUTSIDE IN CANALETTO WALNUT, TOP AND LOW PROFILE IN WALNUT SOLID WOOD 5X2.5 CM

**BACK PANEL** INSIDE OF WOODEN AND GLASS DOORS IN MULTILAYER TANGANICA WALNUT TH. 0.8 CM

**INTERNAL SHELVES** GLASS TH. 0.8

**OPEN ELEMENTS** BLOCKBOARD PANEL: INSIDE VENEERED AND OUTSIDE IN CANALETTO WALNUT TH. 1.8 CM

**BACK PANEL FOR OPEN ELEMENT** MULTILAYER PANEL IN CANALETTO WALNUT TH. 0.8 CM

#### MANIGLIE HANDLES

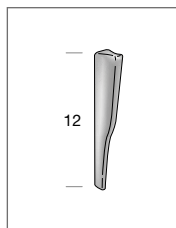

MANIGLIA PICCOLA  
SMALL HANDLE

# SISTEMA COMPONIBILE - MODULAR SYSTEM

ESEMPIO DI BASI A TERRA CON ZOCCOLO E PENSILI FISSATI A PARETE

EXAMPLE OF FLOOR-STANDING WITH PLINTH AND WALL UNITS FIXED TO THE WALL

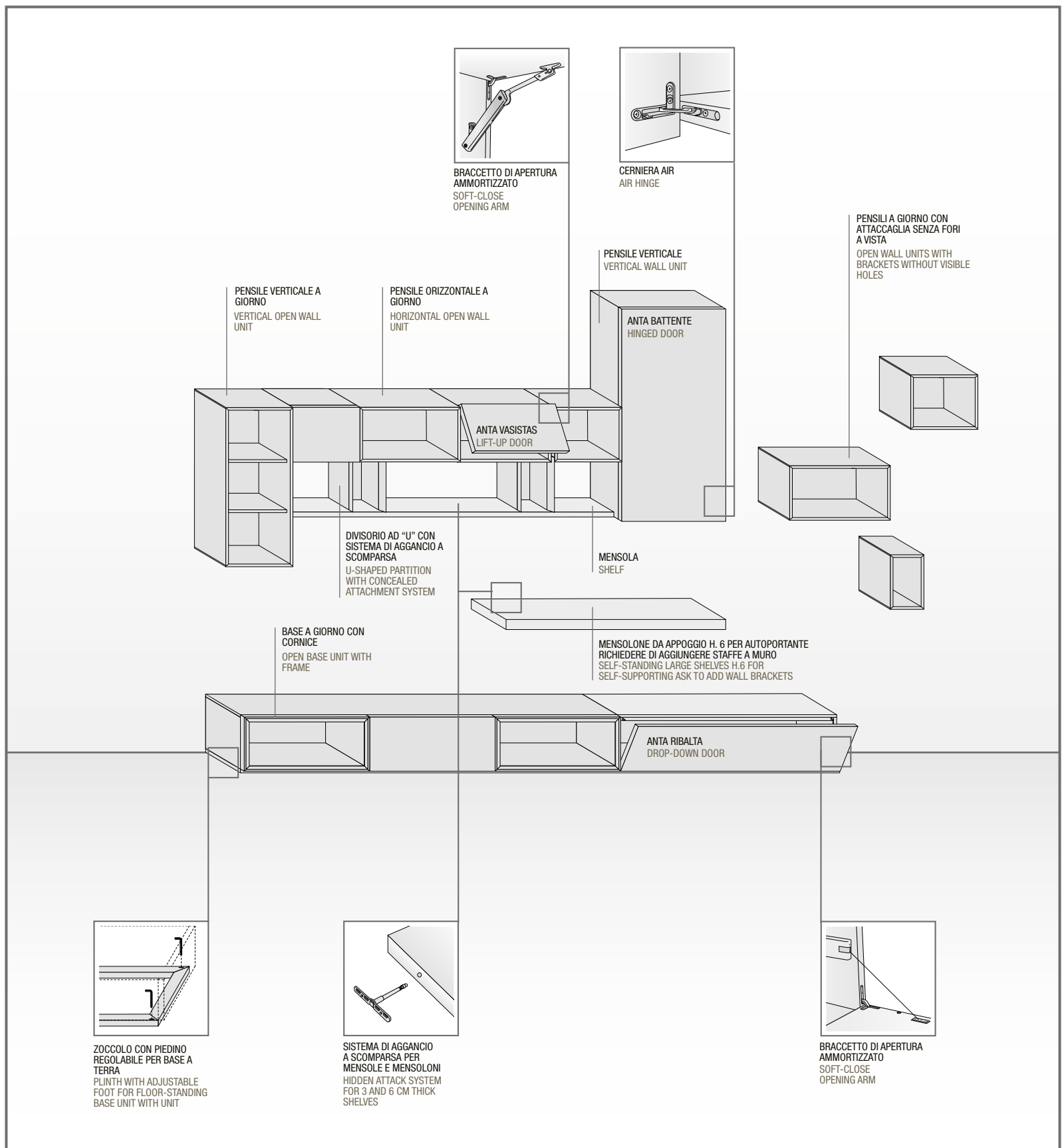

## FRONTALI DOMINO DOMINO FRONTS

### ANTE DOORS

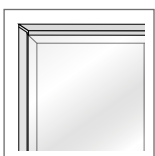

**VETRO**  
(BATTENTE/VASISTAS/  
RIBALTA)  
GLASS  
(HINGED/LIFT-UP/DROP-  
DOWN)

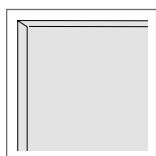

**LEGNO**  
(BATTENTE/VASISTAS/  
RIBALTA)  
WOOD  
(HINGED/LIFT-UP/DROP-  
DOWN)

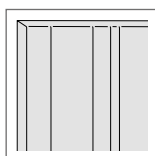

**LEGNO DOGA LEGNO LISCIA**  
(BATTENTE/VASISTAS/  
RIBALTA)  
WOOD, PLAIN WOODEN SLAT  
(HINGED/LIFT-UP/DROP-  
DOWN)

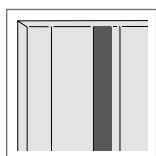

**LEGNO DOGA RIGHE**  
(BATTENTE/VASISTAS/  
RIBALTA)  
STRIPED WOODEN SLAT  
(HINGED/LIFT-UP/DROP-  
DOWN)

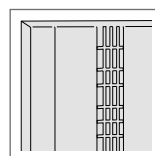

**LEGNO DOGA QUADRO LEGNO**  
(BATTENTE/VASISTAS/  
RIBALTA)  
WOOD, WOODEN SQUARE SLAT  
(HINGED/LIFT-UP/DROP-  
DOWN)

# SISTEMA COMPONIBILE - MODULAR SYSTEM

ESEMPIO DI BASI A TERRA SU PEDANA E PENSILI IN APPOGGIO (COMPOSIZIONE AUTOPORTANTE)

EXAMPLE OF FLOOR-STANDING BASE UNITS ON PLATFORM AND RAISED WALL UNITS (SELF-SUPPORTING COMPOSITION)

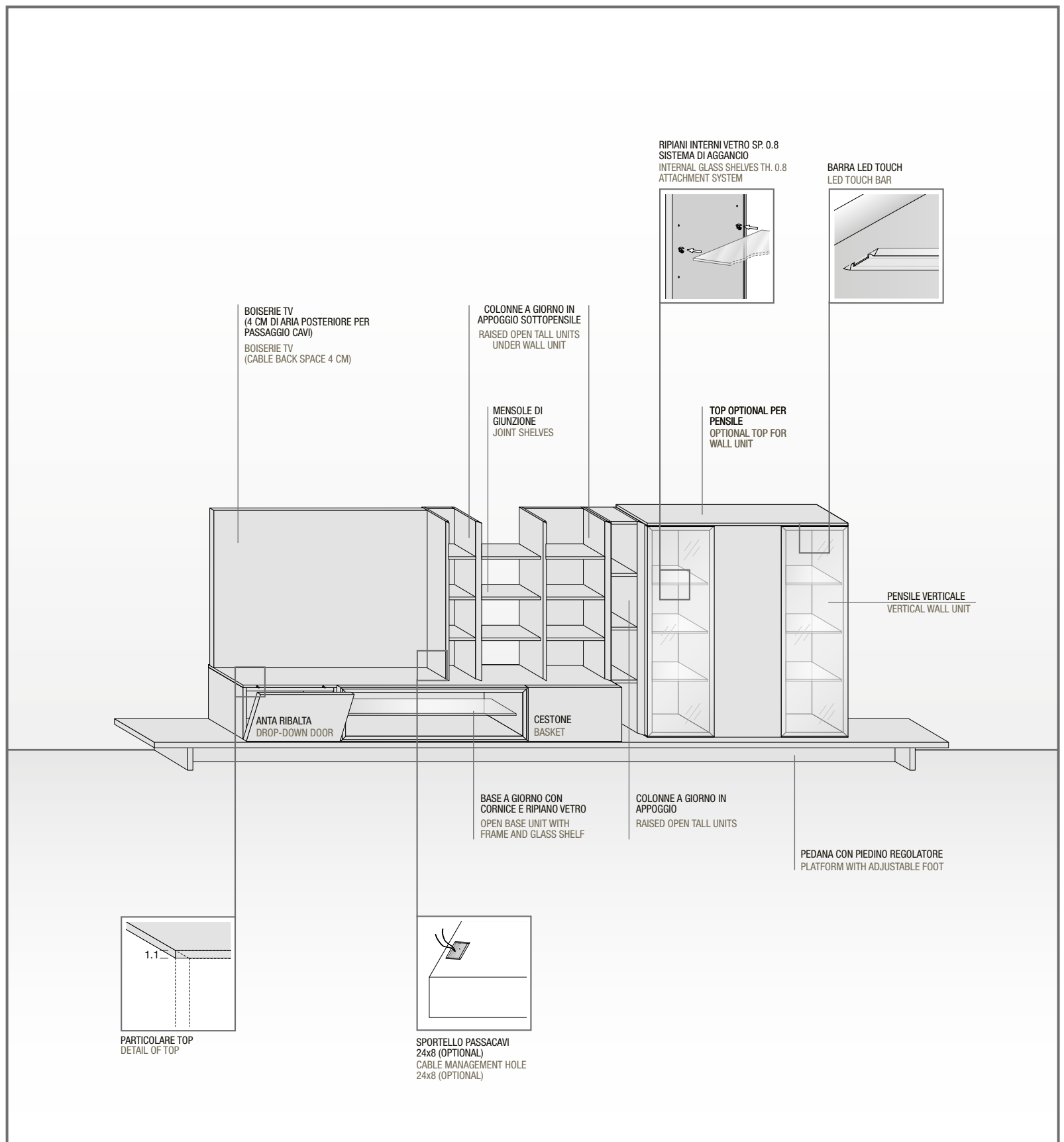

## CESTONI BASKETS

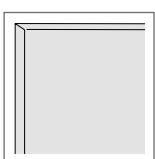

LEGNO  
WOOD

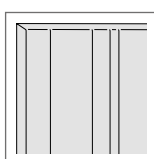

LEGNO DOGA LEGNO  
LISCIA  
WOOD, PLAIN WOODEN  
SLAT

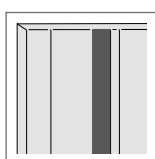

LEGNO DOGA RIGHE  
WOOD, STRIPED SLAT

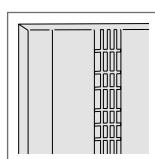

LEGNO DOGA QUADRO  
LEGNO  
WOOD, WOODEN  
SQUARE SLAT

# SISTEMA COMPONIBILE - MODULAR SYSTEM

## MODULARITÀ

## MODULARITY

### BASI A TERRA H. 35 – P. 38/48

#### FLOOR-STANDING BASE UNIT H. 35 – D. 38/48

A GIORNO SU ZOCCOLO  
OPEN ON PLINTH

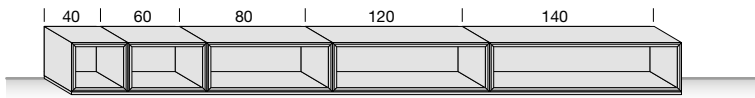

A GIORNO SU PEDANA  
OPEN ON PLATFORM

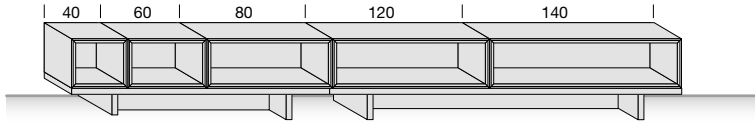

CON CESTONE SU ZOCCOLO  
WITH BASKET ON PLINTH

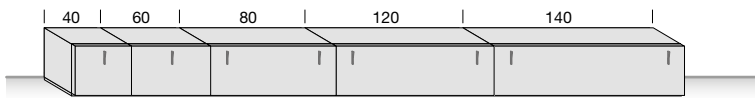

CON CESTONE SU PEDANA  
WITH BASKET ON PLATFORM

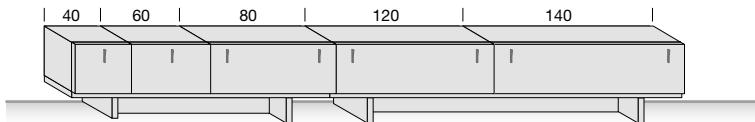

CON ANTA A RIBALTA SU ZOCCOLO  
WITH DROP-DOWN DOOR ON PLINTH

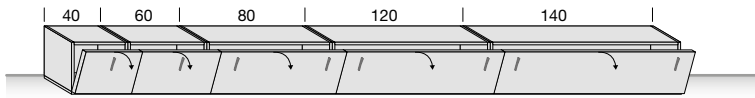

CON ANTA A RIBALTA SU PEDANA  
WITH DROP-DOWN DOOR ON PLATFORM

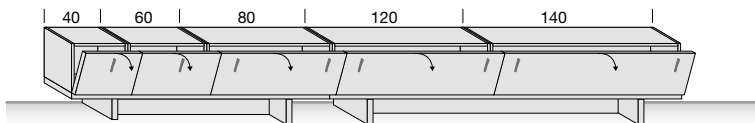

### BASI SOSPESE H. 35 – P. 38/48

#### SUSPENDED BASE UNITS H. 35 – D. 38/48

A GIORNO  
OPEN

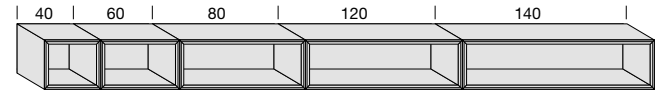

CON CESTONE  
WITH BASKET

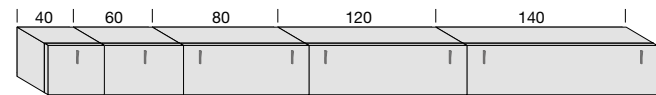

CON ANTA A RIBALTA  
WITH DROP-DOWN DOOR

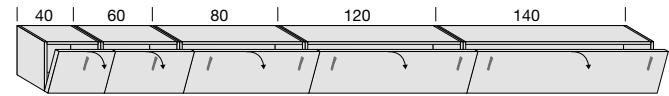

### PENSILI ORIZZONTALI H. 35 – P. 38

#### HORIZONTAL WALL UNITS H. 35 – D. 38

CON ANTA  
WITH DOOR



CON ANTA A RIBALTA  
WITH DROP-DOWN DOOR

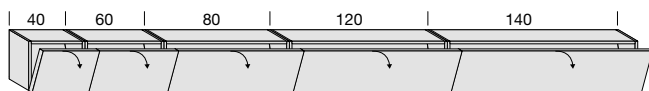

A GIORNO CON CORNICE MASSELLO  
OPEN WITH SOLID FRAME

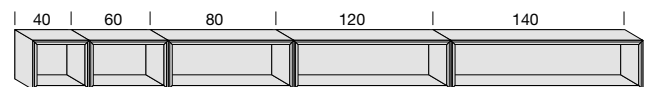

CON ANTA VASISTAS  
WITH LIFT-UP DOOR

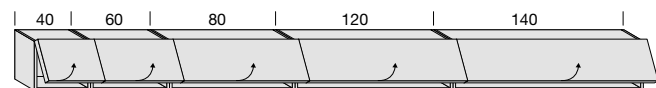



## MODULARITÀ MODULARITY

### PENSILI ORIZZONTALI H. 60 – P. 38 HORIZONTAL WALL UNITS H. 60 – D. 38

CON ANTA  
WITH DOOR



### PENSILI ORIZZONTALI H. 70 – P. 38 HORIZONTAL WALL UNITS H. 70 – D. 38

CON ANTA  
WITH DOOR



### PENSILI VERTICALI H. 105 – P. 38 VERTICAL WALL UNITS H. 105 – D. 38

CON ANTA  
WITH DOOR

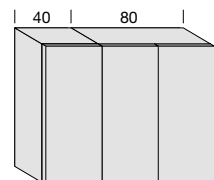

### PENSILI VERTICALI H. 120 – P. 38 VERTICAL WALL UNITS H. 120 – D. 38

CON ANTE  
WITH DOORS

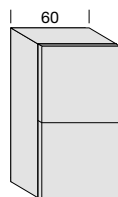

### PENSILI VERTICALI H. 140 – P. 38 VERTICAL WALL UNITS H. 140 – D. 38

CON ANTA  
WITH DOOR

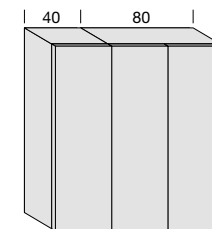

### PENSILI A GIORNO – P. 38 OPEN WALL UNITS – D. 38

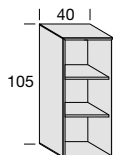
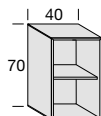
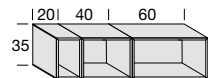

### COLONNE A GIORNO IN APPOGGIO – P. 30 RAISED OPEN TALL UNITS – D. 30

CON CAPPELLO  
WITH TOP

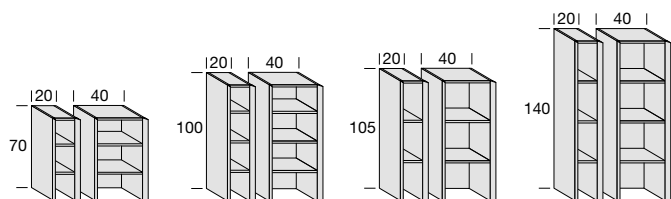

### COLONNE A GIORNO IN APPOGGIO SOTTOPENSILE RAISED OPEN TALL UNITS UNDER WALL UNIT

SENZA CAPPELLO  
WITHOUT TOP

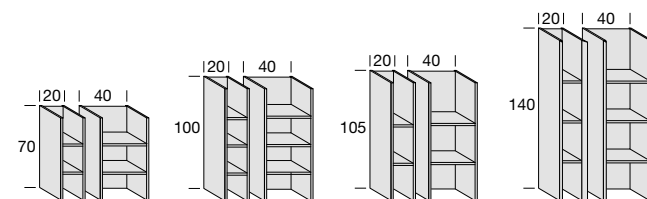

### DIVISORI AD "U" IN APPOGGIO SU MENSOLA E SOTTOPENSILE – P. 30 U-SHAPED PARTITIONS ON SHELF AND UNDER WALL UNIT – D. 30

SENZA TOP E FONDO  
WITHOUT TOP AND BOTTOM

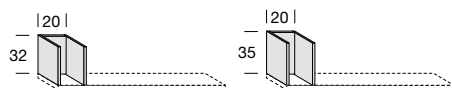

### PANNELLO BOISERIE TV SP. 6 BOISERIE TV PANEL TH. 6

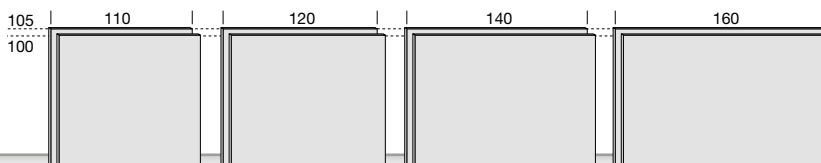

# SISTEMA COMPONIBILE - MODULAR SYSTEM

## CARATTERISTICHE TECNICHE E PARTICOLARITÀ DI UTILIZZO

### TECHNICAL CHARACTERISTICS AND PARTICULAR USE

#### ALTEZZA E LARGHEZZA CESTONI

#### BASKET HEIGHT AND WIDTH

##### FRONTALE CESTONE BASKET FRONT

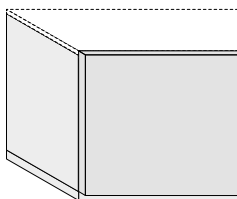

##### ALTEZZE CESTONI BASKET HEIGHTS

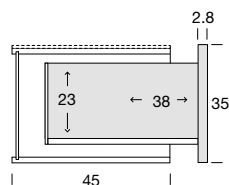
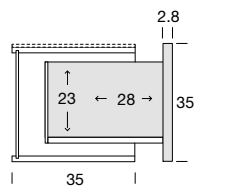

##### LARGHEZZE CESTONI BASKET WIDTHS

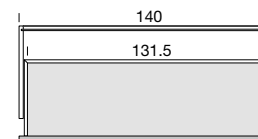
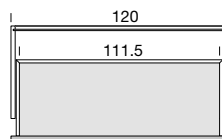
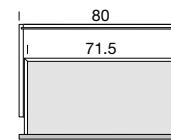
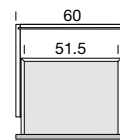
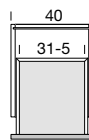

#### ALTEZZE MASSIME DI POSIZIONAMENTO ANTE VASISTAS/RIBALTA

#### MAXIMUM POSITION HEIGHTS FOR LIFT-UP/DROP-DOWN DOORS

#### È POSSIBILE SOVRAPPORRE ANTE VASISTAS SI VASISTAS E RIBALTA SU RIBALTA

IT IS POSSIBLE TO STACK LIFT-UP DOORS ON LIFT-UP DOORS AND DROP-DOWN DOORS ON DROP-DOWN DOORS

##### ANTA VASISTAS LIFT-UP DOOR

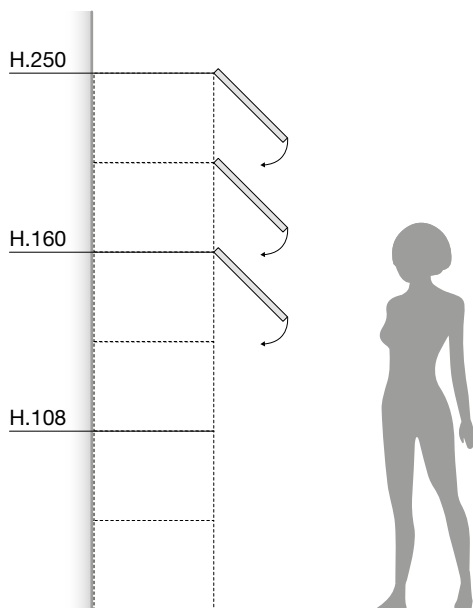

##### ANTA RIBALTA DROP-DOWN DOOR

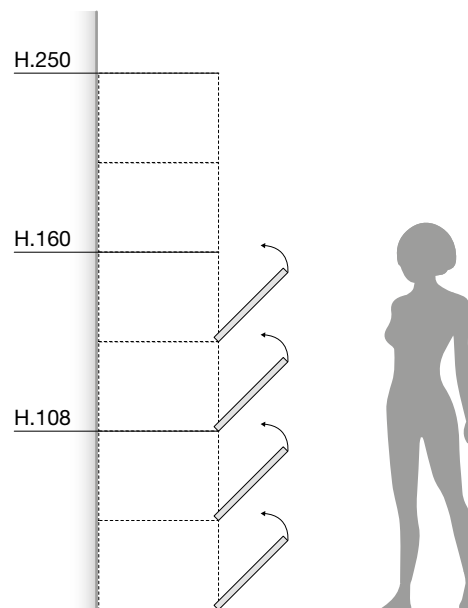

POSIZIONAMENTO ANTE A VASISTAS DA H. 160 A H. 250  
POSITION OF LIFT-UP DOORS FROM H. 160 TO H. 250

POSIZIONAMENTO ANTE A RIBALTA DA H. 4.5 A H. 160  
POSITION OF DROP-DOWN DOORS H. 4.5 A H. 160

## CARATTERISTICHE TECNICHE E PARTICOLARITÀ DI UTILIZZO

### TECHNICAL CHARACTERISTICS AND PARTICULAR USE

#### BASE A GIORNO CON CORNICE APPLICATA P. 38/48

#### OPEN BASE UNIT WITH APPLIED FRAME D. 38/48

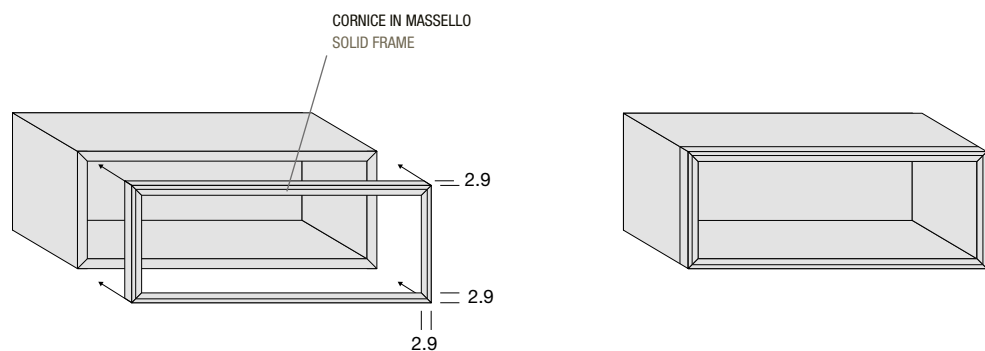

#### PENSILI VERTICALI CON ANTA VETRO P. 38

#### VERTICAL WALL UNITS WITH GLASS DOOR D. 38

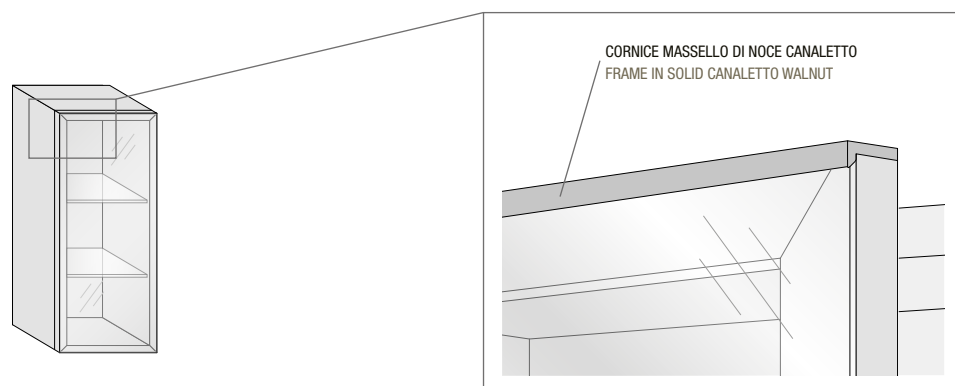

IL VETRO SI INFILA DI LATO E VIENE FISSATO DA DIETRO TRAMITE UN ELEMENTO DECORATIVO DI FORMA CIRCOLARE IN NOCE CANALETTO  
 THE GLASS IS SLOTTED IN FROM THE SIDE AND SECURED FROM BEHIND WITH A CIRCULAR DECORATIVE ELEMENT IN CANALETTO WALNUT.

#### ATTACCAGLIA PER PENSILI (DI SERIE) E

#### BASI SOSPENSE

#### BRACKETS FOR WALL UNITS (AS STANDARD) AND SUSPENDED BASE UNITS

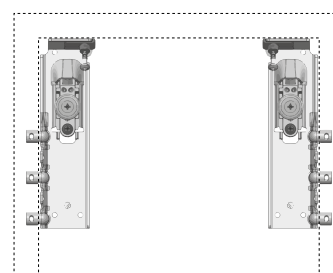

L'ATTACCAGLIA PREVEDE IL MONTAGGIO IN APPOGGIO AL CAPPELLO NEL RETRO DEL MOBILE, CONSENTENDO IL PERFETTO APPOGGIO A MURO.  
 DISPONIBILE DX O SX.  
 PORTATA KG. 70 PER ATTACCAGLIA.

HANGERS ARE TO BE FITTED TO THE FINISHING TOP ON THE BACK OF THE UNIT SO THAT IT CAN ADHERE PERFECTLY TO THE WALL.  
 AVAILABLE R/H OR L/H.  
 CAPACITY 70KG PER HANGER.

#### DIVISORI AD "U" P. 30 PER MENSOLE

#### U-SHAPED PARTITIONS D. 30 FOR SHELVES

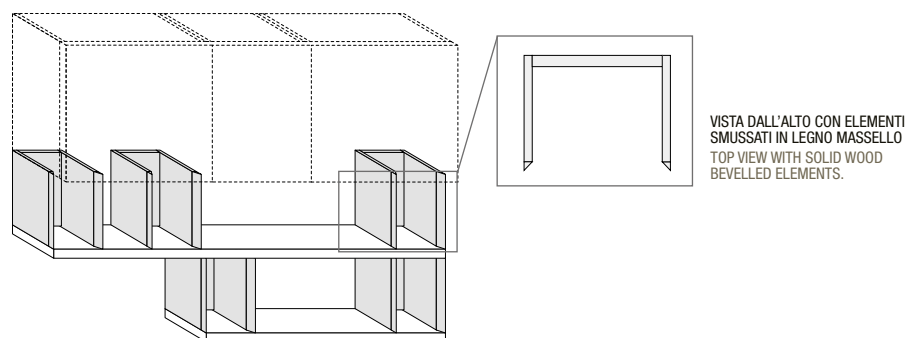

DIVISORI AD "U" SONO DOTATI DI GIUNZIONI INVISIBILI (VEDI ESEMPIO PAG. SEGUENTE)  
 U-SHAPED PARTITIONS ARE FITTED WITH INVISIBLE JOINTS (SEE EXAMPLE IN THE FOLLOWING PAGE)

# SISTEMA COMPONIBILE - MODULAR SYSTEM

## CARATTERISTICHE TECNICHE E PARTICOLARITÀ DI UTILIZZO

### TECHNICAL CHARACTERISTICS AND PARTICULAR USE

#### UTILIZZO COLONNE A GIORNO P. 38

#### USE OF OPEN TALL UNITS D. 38

#### ESEMPIO DI COMPOSIZIONE COLONNE A GIORNO IN APPOGGIO SOTTOPENSILE E MENSOLE DI GIUNZIONE

#### EXAMPLE OF COMPOSITION WITH RAISED TALL UNITS UNDER WALL UNIT AND JOINT SHELVES

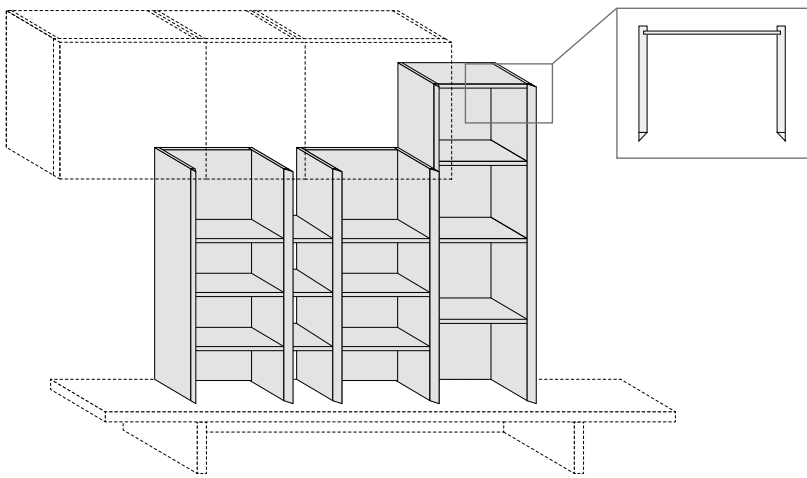

VISTA DALL'ALTO CON ELEMENTI SMUSSATI IN LEGNO MASSELLO  
TOP VIEW WITH SOLID WOOD BEVELLED ELEMENTS.

#### ESEMPIO DI COMPOSIZIONE COLONNE A GIORNO IN APPOGGIO E MENSOLE DI GIUNZIONE

#### EXAMPLE OF COMPOSITION WITH RAISED TALL UNITS AND JOINT SHELVES

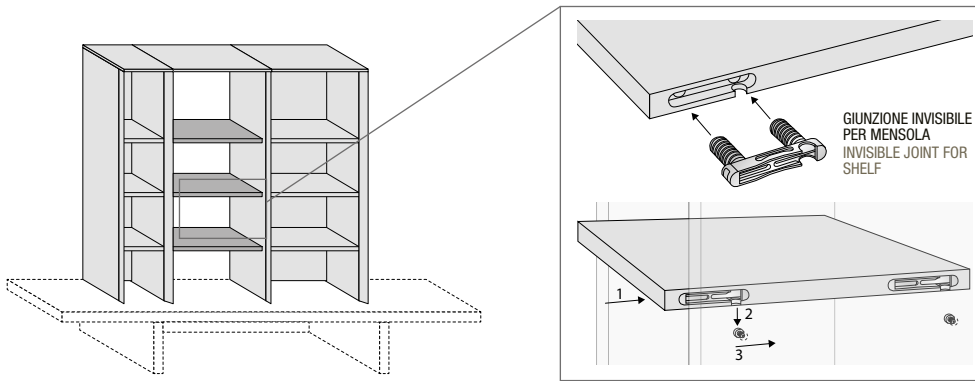

GIUNZIONE INVISIBILE PER MENSOLA  
INVISIBLE JOINT FOR SHELF

#### ATTACCAGLIA PER PENSILI (DI SERIE) E BASI SOSPENSE

#### BRACKETS FOR WALL UNITS (AS STANDARD) AND SUSPENDED BASE UNITS

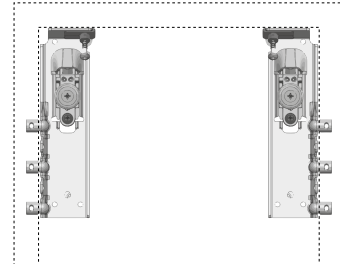

L'ATTACCAGLIA PREVEDE IL MONTAGGIO IN APPOGGIO AL CAPPELLO NEL RETRO DEL MOBILE, CONSENTENDO IL PERFETTO APPOGGIO A MURO.  
DISPONIBILE DX O SX.  
PORTATA KG. 70 PER ATTACCAGLIA.

HANGERS ARE TO BE FITTED TO THE FINISHING TOP ON THE BACK OF THE UNIT SO THAT IT CAN ADHERE PERFECTLY TO THE WALL.  
AVAILABLE R/H OR L/H.  
CAPACITY 70KG PER HANGER.

#### TOP OBBLIGATORIO PER BASI

#### COMPULSORY TOP FOR BASE UNITS

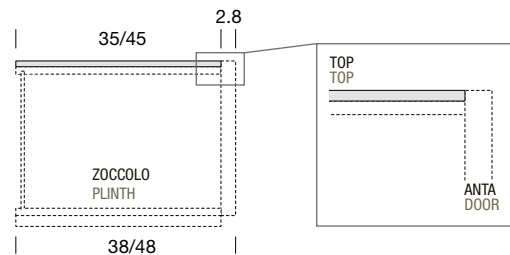
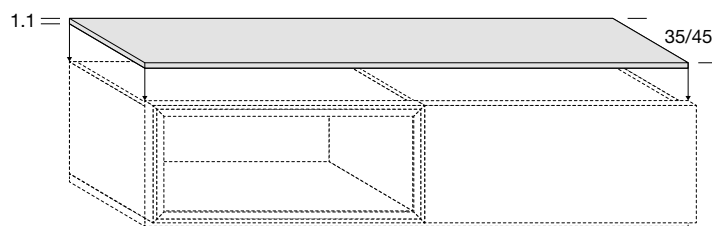

#### PEDANE P. 49 CON PIEDINO REGOLATORE

#### PLATFORMS D. 49 WITH ADJUSTABLE FOOT

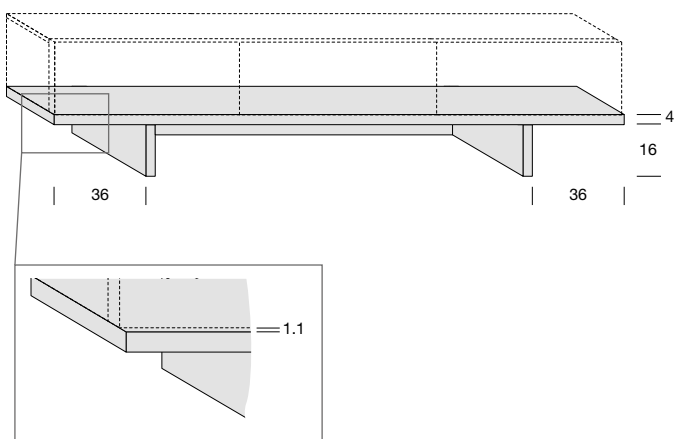

#### ZOCCOLI P. 35/45 CON PIEDINO REGOLATORE

#### PLINTHS D. 35/45 WITH ADJUSTABLE FOOT

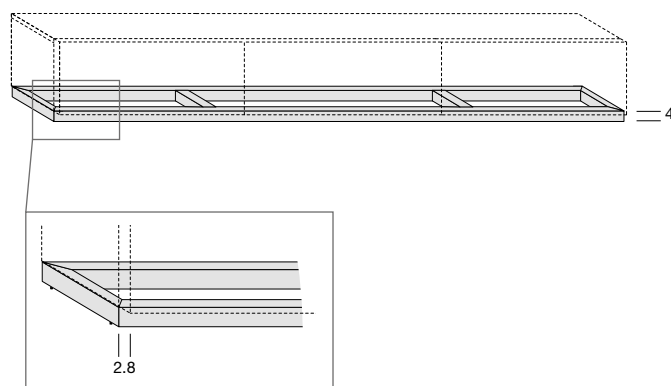

## ACCESSORI OPTIONAL OPTIONAL ACCESSORIES

### BARRA LED A BASSO CONSUMO ACCENSIONE TOUCH IN ALLUMINIO

COLLEGAMENTO  
A CARICO DEL CLIENTE

### LOW CONSUMPTION ALUMINIUM LED BAR WITH TOUCH SWITCH ON

CONNECTIONS  
TO BE MADE BY THE CUSTOMER.



larghezza width	codice code	NOCE-FRASSINO WALNUT-ASHWOOD
40	ZZZFE22020	163
60	ZZZFE22024	175
80	ZZZFE22025	187
120	ZZZFE22026	235
140	ZZZFE22027	253

### ALIMENTATORE POWER SUPPLY

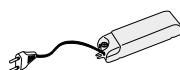

codice code	
ZZZFE22002	67

### TELECOMANDO REMOTE CONTROL



codice code	
ZZZFE22004	158

### KIT SPORTELLLO PASSACAVI + BORCHIA

KIT FOR CABLE MANAGEMENT HOLE  
+ COVER

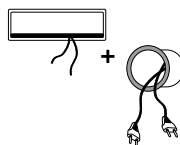

codice code	
ZZZFE22005	133

### MULTIPRESA A SCOMPARSA CON SPORTELLINO APRI/CHIUDI IN METALLO

CONCEALED MULTIPLE SOCKET  
WITH METAL OPEN/CLOSE FLAP

VERSIONE TV:  
1 PRESA SCHUKO  
2 PRESA USB RICARICA  
1 PRESA SAT.  
TV VERSION:  
1 SCHUKO SOCKET  
2 SOCKETS USB CHARGE  
1 SAT. SOCKET



codice code	
ZZZFE22030	595

VERSIONE PC/MAC:  
1 PRESA SCHUKO  
2 PORTE USB DATI  
1 PORTA HDMI  
PC/MAC VERSION:  
1 SCHUKO SOCKET  
2 USB PORT  
1 HDMI PORT



codice code	
ZZZFE22031	595

# SISTEMA COMPONIBILE - MODULAR SYSTEM

## ELEMENTI STRUTTURALI STRUCTURAL ELEMENTS

### MENSOLE SP. 3 P. 30 SHELVES TH. 3 D. 30

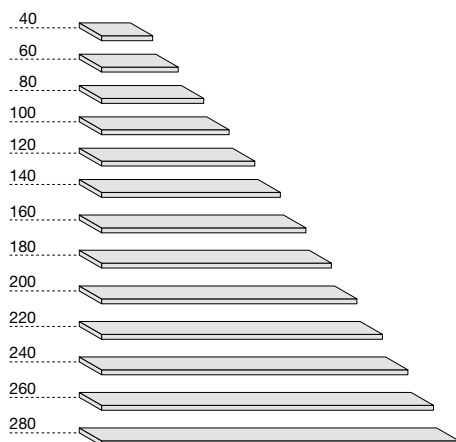

larghezza width	codice code	CANALETTO	
40	DOC3501K	97	mc 0,1 – Kg 2
60	DOC3511K	120	mc 0,01 – Kg 3
80	DOC3521K	158	mc 0,01 – Kg 4
100	DOC3531K	181	mc 0,01 – Kg 5
120	DOC3541K	217	mc 0,01 – Kg 6
140	DOC3551K	247	mc 0,01 – Kg 7
160	DOC3561K	278	mc 0,02 – Kg 8
180	DOC3571K	301	mc 0,02 – Kg 9
200	DOC3581K	338	mc 0,02 – Kg 10
220	DOC3591K	374	mc 0,02 – Kg 11
240	DOC3601K	404	mc 0,02 – Kg 12
260	DOC3611K	427	mc 0,03 – Kg 13
280	DOC3621K	457	mc 0,03 – Kg 14

### MENSOLONI SP. 6 P 50 DA APPOGGIO POSIZIONABILI MAX H. 1,2 METRI PER AUTOPORTANTE AGGIUNGERE STAFFE DA MURO (+ 50,00 €)

### LARGE SHELVES TH. 6 D 50 SELF-STANDING 1,2 METER MAX ADJUSTABLE FOR SELF-SUPPORTING ADD WALL BRACKETS (+ 50,00 €)

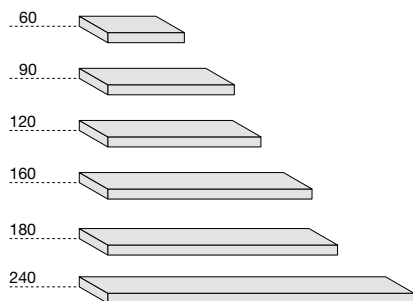

larghezza width	codice code	CANALETTO	
60	DOC3701K	253	mc 0,04 – Kg 8
90	DOC3711K	361	mc 0,06 – Kg 12
120	DOC3721K	476	mc 0,08 – Kg 16
160	DOC3731K	595	mc 0,16 – Kg 21
180	DOC3741K	668	mc 0,10 – Kg 24
240	DOC3751K	854	mc 0,15 – Kg 32

### BOISERIE TV SP. 5.7 TV BOISERIE TH. 5.7

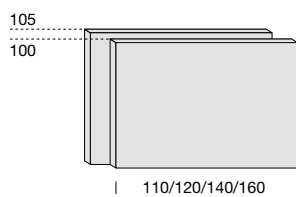

altezza height	larghezza width	codice code	CANALETTO	
100	110	DOC7041K	577	mc 0,07 – Kg 28
100	120	DOC7051K	644	mc 0,08 – Kg 34
100	140	DOC7061K	727	mc 0,10 – Kg 40
100	160	DOC7071K	813	mc 0,12 – Kg 42
105	110	DOC7011K	595	mc 0,07 – Kg 28
105	120	DOC7021K	655	mc 0,08 – Kg 34
105	140	DOC7031K	740	mc 0,10 – Kg 40
105	160	DOC7081K	823	mc 0,12 – Kg 42

### PEDANE H. 20 P. 49 PLATFORMS H. 20 D. 49

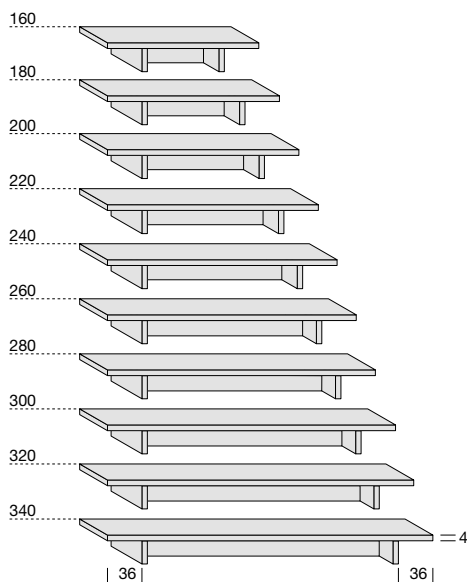

larghezza width	codice code	CANALETTO	
160	DOC3381K	615	mc 0,16 – Kg 18
180	DOC3000K	650	mc 0,22 – Kg 20
200	DOC3001K	692	mc 0,22 – Kg 22
220	DOC3011K	746	mc 0,24 – Kg 24
240	DOC3021K	800	mc 0,26 – Kg 26
260	DOC3031K	848	mc 0,28 – Kg 28
280	DOC3041K	938	mc 0,30 – Kg 30
300	DOC3051K	999	mc 0,32 – Kg 32
320	DOC3061K	1.023	mc 0,34 – Kg 34
340	DOC3071K	1.047	mc 0,37 – Kg 36

## ELEMENTI STRUTTURALI STRUCTURAL ELEMENTS

ZOCCOLI H. 4 P. 35  
PLINTHS H. 4 D. 35

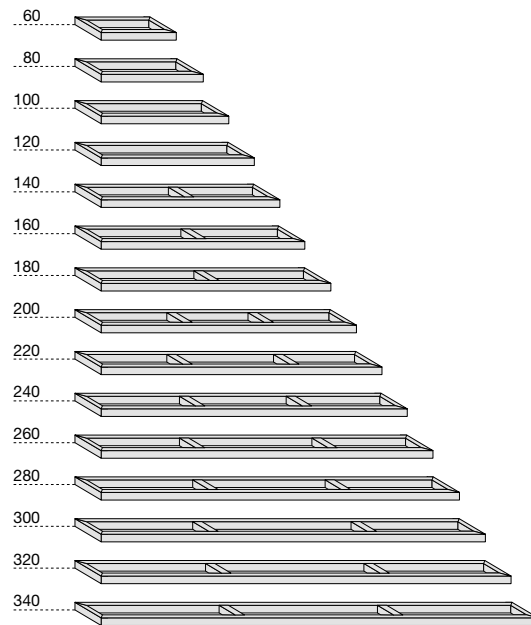

larghezza width	codice code	CANALETTO	
60	DOC3231K	181	mc 0,01 – Kg 1
80	DOC3241K	193	mc 0,02 – Kg 1
100	DOC3251K	198	mc 0,03 – Kg 2
120	DOC3261K	211	mc 0,03 – Kg 2
140	DOC3271K	223	mc 0,03 – Kg 2
160	DOC3281K	259	mc 0,03 – Kg 2
180	DOC3291K	278	mc 0,03 – Kg 2
200	DOC3301K	326	mc 0,03 – Kg 4
220	DOC3311K	338	mc 0,03 – Kg 4
240	DOC3321K	349	mc 0,04 – Kg 4
260	DOC3331K	361	mc 0,03 – Kg 5
280	DOC3341K	409	mc 0,03 – Kg 6
300	DOC3351K	422	mc 0,05 – Kg 6
320	DOC3361K	439	mc 0,05 – Kg 6
340	DOC3371K	457	mc 0,05 – Kg 7

ZOCCOLI H. 4 P. 45  
PLINTHS H. 4 D. 45

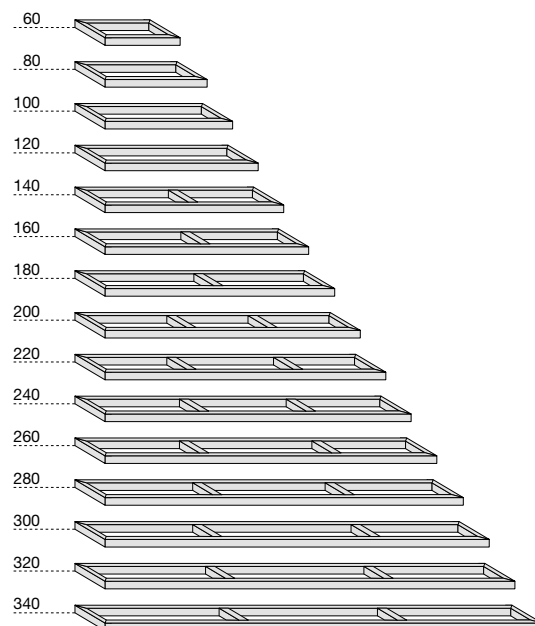

larghezza width	codice code	CANALETTO	
60	DOC3081K	181	mc 0,02 – Kg 1
80	DOC3091K	193	mc 0,02 – Kg 1
100	DOC3101K	206	mc 0,02 – Kg 2
120	DOC3111K	217	mc 0,02 – Kg 2
140	DOC3121K	235	mc 0,03 – Kg 2
160	DOC3131K	259	mc 0,03 – Kg 3
180	DOC3141K	278	mc 0,04 – Kg 03
200	DOC3151K	326	mc 0,04 – Kg 5
220	DOC3161K	338	mc 0,04 – Kg 5
240	DOC3171K	349	mc 0,05 – Kg 5
260	DOC3181K	366	mc 0,05 – Kg 5
280	DOC3191K	409	mc 0,06 – Kg 7
300	DOC3201K	427	mc 0,06 – Kg 7
320	DOC3211K	446	mc 0,06 – Kg 7
340	DOC3221K	457	mc 0,06 – Kg 8

# SISTEMA COMPONIBILE - MODULAR SYSTEM

## ELEMENTI STRUTTURALI STRUCTURAL ELEMENTS

**TOP SP. 1.1 P 35**  
**OBBLIGATORIO PER BASI**

**TOP TH. 1.1 D 35**  
**COMPULSORY FOR BASE**  
**UNITS**

**IL PREZZO DEL TOP DEVE ESSERE SOMMATO A QUELLO DELLE BASI**  
**ADD THE PRICE OF THE TOP TO THE PRICE OF THE BASE UNITS.**

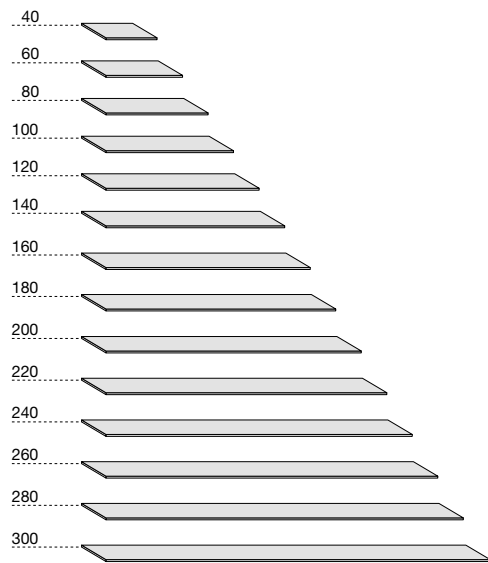

larghezza width	codice code	CANALETTO	
40	DOC5151K	61	mc 0,05 – Kg 1
60	DOC5161K	85	mc 0,05 – Kg 1
80	DOC5171K	102	mc 0,05 – Kg 1
100	DOC5181K	158	mc 0,05 – Kg 2
120	DOC5191K	133	mc 0,05 – Kg 2
140	DOC5201K	193	mc 0,05 – Kg 2
160	DOC5211K	223	mc 0,05 – Kg 3
180	DOC5221K	241	mc 0,06 – Kg 3
200	DOC5231K	253	mc 0,06 – Kg 4
220	DOC5241K	265	mc 0,06 – Kg 4
240	DOC5251K	289	mc 0,06 – Kg 4
260	DOC5261K	301	mc 0,06 – Kg 5
280	DOC5271K	326	mc 0,06 – Kg 5
300	DOC5281K	356	mc 0,06 – Kg 5

**TOP SP. 1.1 P 45**  
**OBBLIGATORIO PER BASI**

**TOP TH. 1.1 D 45**  
**COMPULSORY FOR BASE**  
**UNITS**

**IL PREZZO DEL TOP DEVE ESSERE SOMMATO A QUELLO DELLE BASI**  
**ADD THE PRICE OF THE TOP TO THE PRICE OF THE BASE UNITS.**

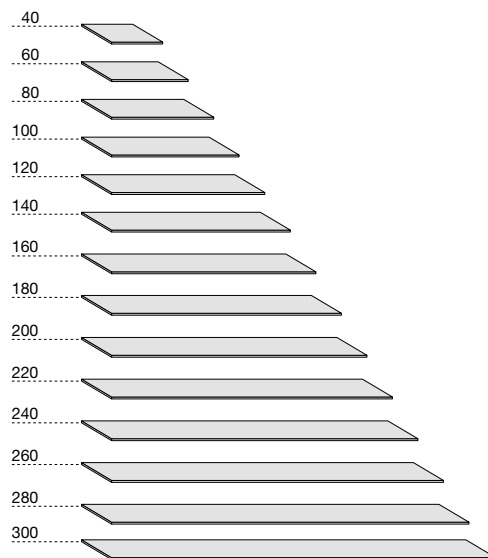

larghezza width	codice code	CANALETTO	
40	DOC5001K	67	mc 0,03 – Kg 1
60	DOC5011K	91	mc 0,05 – Kg 1
80	DOC5021K	115	mc 0,05 – Kg 2
100	DOC5031K	150	mc 0,05 – Kg 2
120	DOC5041K	175	mc 0,05 – Kg 3
140	DOC5051K	206	mc 0,05 – Kg 3
160	DOC5061K	253	mc 0,05 – Kg 4
180	DOC5071K	271	mc 0,06 – Kg 4
200	DOC5081K	295	mc 0,06 – Kg 5
220	DOC5091K	326	mc 0,06 – Kg 5
240	DOC5101K	349	mc 0,06 – Kg 5
260	DOC5111K	374	mc 0,06 – Kg 6
280	DOC5121K	397	mc 0,06 – Kg 6
300	DOC5131K	422	mc 0,06 – Kg 7



## ELEMENTI STRUTTURALI STRUCTURAL ELEMENTS

TOP SP. 1.3 P 38  
OPTIONAL PER PENSILI E  
MADIE

TOP TH. 1.3 D 38  
OPTIONAL FOR WALL UNITS  
AND CUPBOARDS

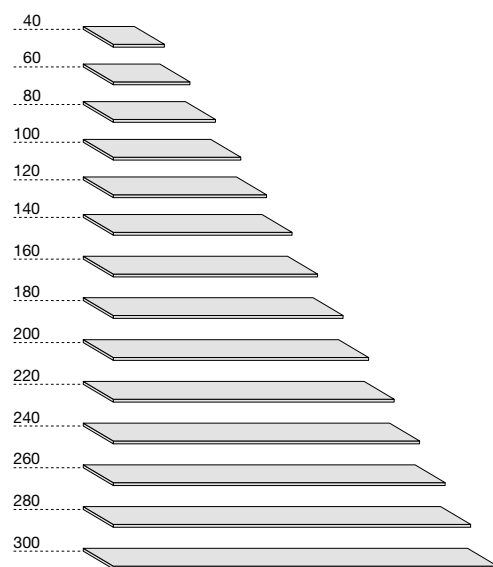

larghezza width	codice code	CANALETTO	
40	DOC5300K	91	mc 0,05 – Kg 1
60	DOC5301K	97	mc 0,05 – Kg 1
80	DOC5311K	115	mc 0,05 – Kg 1
100	DOC5321K	150	mc 0,05 – Kg 2
120	DOC5331K	181	mc 0,05 – Kg 2
140	DOC5341K	217	mc 0,05 – Kg 2
160	DOC5351K	253	mc 0,05 – Kg 3
180	DOC5361K	271	mc 0,06 – Kg 3
200	DOC5371K	289	mc 0,06 – Kg 4
220	DOC5381K	308	mc 0,06 – Kg 4
240	DOC5391K	338	mc 0,06 – Kg 4
260	DOC5401K	361	mc 0,06 – Kg 5
280	DOC5411K	386	mc 0,06 – Kg 5
300	DOC5421K	409	mc 0,06 – Kg 5

# SISTEMA COMPONIBILE - MODULAR SYSTEM

## BASI A TERRA P. 38

### FLOOR-STANDING BASE UNITS D. 38

#### BASI H. 35 BASE UNITS H. 35

A GIORNO  
OPEN

A GIORNO, 1 RIPIANO VETRO  
OPEN ON PLATFORM, 1 GLASS SHELF

1 CESTONE  
1 BASKET

1 CESTONE  
1 BASKET



**OBBLIGATORIO: AGGIUNGERE TOP E PEDANA O ZOCCOLO A TERRA.**  
**COMPULSORY: ADD TOP AND PLATFORM OR PLINTH ON FLOOR.**

**DOC1511K**

**DOC1561K**

**DOC1311K**

DOGA LEGNO LISCIA  
PLAIN WOODEN SLAT

**DOC1316K** **OPTIONAL**

DOGA SLAT  
DOGA RIGHE  
STRIPED SLAT

CANALETTO

**529**

**559**

**680**

**903**

**+ 67**

Doghe Multicolor - Multicolor slats

mc 0,06 - Kg 5

mc 0,06 - Kg 5

mc 0,06 - Kg 10

mc 0,06 - Kg 10

1 CESTONE  
1 BASKET

1 CESTONE  
1 BASKET

1 RIBALTA  
1 DROP-DOWN DOOR

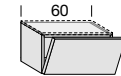
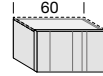
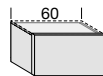

**OBBLIGATORIO: AGGIUNGERE TOP E PEDANA O ZOCCOLO A TERRA.**  
**COMPULSORY: ADD TOP AND PLATFORM OR PLINTH ON FLOOR.**

**DOC1331K**

DOGA LEGNO LISCIA  
PLAIN WOODEN SLAT

**DOC1336K**

**OPTIONAL**

**DOC1431K**

CANALETTO

**788**

**1.029**

**+ 67**

**800**

Doghe Multicolor - Multicolor slats

mc 0,09 - Kg 12

mc 0,09 - Kg 12

DOGA SLAT  
DOGA RIGHE  
STRIPED SLAT

DOGA QUADRO LEGNO  
WOODEN SQUARE SLAT

mc 0,09 - Kg 10

1 CESTONE  
1 BASKET

1 CESTONE  
1 BASKET

1 RIBALTA  
1 DROP-DOWN DOOR

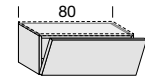
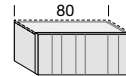

**OBBLIGATORIO: AGGIUNGERE TOP E PEDANA O ZOCCOLO A TERRA.**  
**COMPULSORY: ADD TOP AND PLATFORM OR PLINTH ON FLOOR.**

**DOC1351K**

DOGA LEGNO LISCIA  
PLAIN WOODEN SLAT

**DOC1356K**

**OPTIONAL**

**DOC1451K**

CANALETTO

**903**

**1.155**

**+ 67**

**890**

Doghe Multicolor - Multicolor slats

mc 0,12 - Kg 16

mc 0,09 - Kg 16

DOGA SLAT  
DOGA RIGHE  
STRIPED SLAT

DOGA QUADRO LEGNO  
WOODEN SQUARE SLAT

mc 0,12 - Kg 8

1 CESTONE  
1 BASKET

1 CESTONE  
1 BASKET

1 RIBALTA  
1 DROP-DOWN DOOR

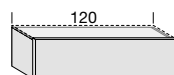

**OBBLIGATORIO: AGGIUNGERE TOP E PEDANA O ZOCCOLO A TERRA.**  
**COMPULSORY: ADD TOP AND PLATFORM OR PLINTH ON FLOOR.**

**DOC1371K**

DOGA LEGNO LISCIA  
PLAIN WOODEN SLAT

**DOC1376K**

**OPTIONAL**

**DOC1471K**

CANALETTO

**1.047**

**1.341**

**+ 67**

**1.011**

Doghe Multicolor - Multicolor slats

mc 0,18 - Kg 18

mc 0,18 - Kg 18

DOGA SLAT  
DOGA RIGHE  
STRIPED SLAT

DOGA QUADRO LEGNO  
WOODEN SQUARE SLAT

mc 0,18 - Kg 15

1 RIBALTA  
1 DROP-DOWN DOOR



**DOC1411K**

**703**

+ 5 %

mc 0,06 – Kg 8

1 RIBALTA  
1 DROP-DOWN DOOR



DOGA LEGNO LISCIA  
PLAIN WOODEN SLAT

**DOC1416K**

**944**

+ 5 %

mc 0,06 – Kg 8

**OPTIONAL**

DOGA SLAT  
DOGA RIGHE  
STRIPED SLAT

+ 67

A GIORNO  
OPEN

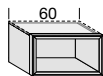

**DOC1521K**

**638**

mc 0,09 – Kg 7

A GIORNO, 1 RIPIANO VETRO  
OPEN ON PLATFORM, 1 GLASS SHELF

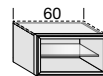

**DOC1571K**

**674**

mc 0,09 – Kg 7

**OPTIONAL**  
**OPTIONAL**

KIT SPORTELLINO PASSACAVI  
+ BORCHIA  
KIT FOR CABLE MANAGEMENT HOLE  
+ COVER

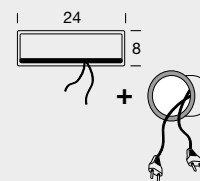

**ZZZFE22005**

**133**

1 RIBALTA  
1 DROP-DOWN DOOR

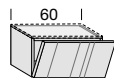

DOGA LEGNO LISCIA  
PLAIN WOODEN SLAT

**DOC1436K**

**1.052**

+ 5 %

mc 0,09 – Kg 10

**OPTIONAL**

DOGA SLAT  
DOGA RIGHE  
STRIPED SLAT

+ 67

+ 97

A GIORNO  
OPEN

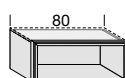

**DOC1531K**

**727**

mc 0,12 – Kg 11

A GIORNO, 1 RIPIANO VETRO  
OPEN ON PLATFORM, 1 GLASS SHELF

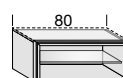

**DOC1581K**

**764**

mc 0,12 – Kg 11

1 RIBALTA  
1 DROP-DOWN DOOR

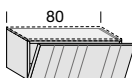

DOGA LEGNO LISCIA  
PLAIN WOODEN SLAT

**DOC1456K**

**1.173**

+ 5 %

mc 0,12 – Kg 8

**OPTIONAL**

DOGA SLAT  
DOGA RIGHE  
STRIPED SLAT

+ 67

+ 97

A GIORNO  
OPEN

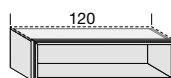

**DOC1541K**

**842**

mc 0,18 – Kg 13

A GIORNO, 1 RIPIANO VETRO  
OPEN ON PLATFORM, 1 GLASS SHELF



**DOC1591K**

**909**

mc 0,18 – Kg 13

1 RIBALTA  
1 DROP-DOWN DOOR

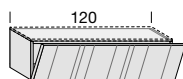

DOGA LEGNO LISCIA  
PLAIN WOODEN SLAT

**DOC1476K**

**1.328**

+ 5 %

mc 0,18 – Kg 15

**OPTIONAL**

DOGA SLAT  
DOGA RIGHE  
STRIPED SLAT

+ 67

+ 97

A GIORNO  
OPEN

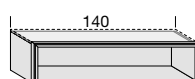

**DOC1551K**

**932**

mc 0,21 – Kg 15

A GIORNO, 1 RIPIANO VETRO  
OPEN ON PLATFORM, 1 GLASS SHELF

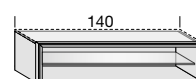

**DOC1601K**

**999**

mc 0,21 – Kg 15

# SISTEMA COMPONIBILE - MODULAR SYSTEM

## BASI A TERRA P. 38

### FLOOR-STANDING BASE UNITS D. 38

#### BASI H. 35 BASE UNITS H. 35

A GIORNO, 3 DIVISORI  
OPEN, 3 PARTITIONS

1 CESTONE  
1 BASKET

1 CESTONE  
1 BASKET

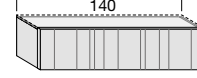
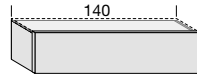
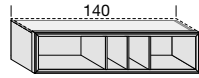

**OBBLIGATORIO: AGGIUNGERE TOP E PEDANA O ZOCCOLO A TERRA.**  
**COMPULSORY: ADD TOP AND PLATFORM OR PLINTH ON FLOOR.**

**DOC1611K**

**DOC1391K**

DOGA LEGNO LISCIA  
PLAIN WOODEN SLAT

**DOC1396K**

**OPTIONAL**

CANALETTO

Doghe Multicolor - Multicolor slats

**1.136**

**1.149**  
**+ 5 %**

**1.408**  
**+ 5 %**

DOGA SLAT  
DOGA RIGHE STRIPED SLAT  
DOGA QUADRO LEGNO WOODEN SQUARE SLAT

**+ 67**      **+ 97**

mc 0,21 - Kg 15

mc 0,21 - Kg 20

mc 0,21 - Kg 20

#### SHANGHAI BASI H. 35 SHANGHAI BASE UNITS H. 35

1 CESTONE  
1 BASKET

1 RIBALTA  
1 DROP-DOWN DOOR

1 CESTONE  
1 BASKET

1 RIBALTA  
1 DROP-DOWN DOOR

**NEW**

**NEW**

**NEW**

**NEW**

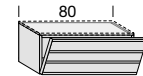
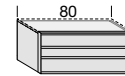
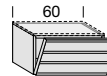
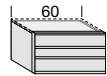

**OBBLIGATORIO: AGGIUNGERE TOP E PEDANA O ZOCCOLO A TERRA.**  
**COMPULSORY: ADD TOP AND PLATFORM OR PLINTH ON FLOOR.**

**SHC1001K**

**SHC1041K**

**SHC1011K**

**SHC1051K**

CANALETTO

Bicolore - Bicolor

**866**  
**+ 5 %**

**903**  
**+ 5 %**

**956**  
**+ 5 %**

**992**  
**+ 5 %**

mc 0,09 - Kg 12

mc 0,09 - Kg 10

mc 0,12 - Kg 16

mc 0,12 - Kg 8

#### BASI A TERRA P. 48 FLOOR-STANDING BASE UNITS D. 48

#### BASI H. 35 BASE UNITS H. 35

A GIORNO  
OPEN

A GIORNO, 1 RIPIANO VETRO  
OPEN ON PLATFORM, 1 GLASS SHELF

1 CESTONE  
1 BASKET

1 CESTONE  
1 BASKET

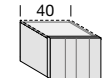
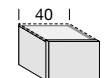
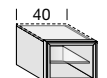
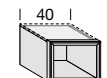

**OBBLIGATORIO: AGGIUNGERE TOP E PEDANA O ZOCCOLO A TERRA.**  
**COMPULSORY: ADD TOP AND PLATFORM OR PLINTH ON FLOOR.**

**DOC1211K**

**DOC1261K**

**DOC1001K**

DOGA LEGNO LISCIA  
PLAIN WOODEN SLAT

**DOC1006K**

CANALETTO

Doghe Multicolor - Multicolor slats

**542**

**572**

**698**  
**+ 5 %**

**920**  
**+ 5 %**

mc 0,07 - Kg 6

mc 0,07 - Kg 6

mc 0,07 - Kg 12

mc 0,07 - Kg 12

A GIORNO  
OPEN

A GIORNO, 1 RIPIANO VETRO  
OPEN ON PLATFORM, 1 GLASS SHELF

1 CESTONE  
1 BASKET

1 CESTONE  
1 BASKET

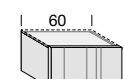
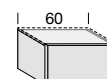
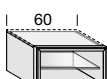
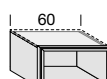

**OBBLIGATORIO: AGGIUNGERE TOP E PEDANA O ZOCCOLO A TERRA.**  
**COMPULSORY: ADD TOP AND PLATFORM OR PLINTH ON FLOOR.**

**DOC1221K**

**DOC1271K**

**DOC1021K**

DOGA LEGNO LISCIA  
PLAIN WOODEN SLAT

**DOC1026K**

CANALETTO

Doghe Multicolor - Multicolor slats

**650**

**686**

**800**  
**+ 5 %**

**1.041**  
**+ 5 %**

mc 0,11 - Kg 8

mc 0,11 - Kg 8

mc 0,11 - Kg 15

mc 0,11 - Kg 15

1 RIBALTA  
1 DROP-DOWN DOOR

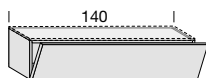

**DOC1491K**

**1.160**  
**+ 5 %**

mc 0,21 – Kg 17

1 CESTONE  
1 BASKET

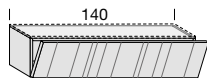

DOGA LEGNO LISCIA  
PLAIN WOODEN SLAT

**DOC1496K**

**1.443**  
**+ 5 %**

mc 0,21 – Kg 17

**OPTIONAL**

DOGA SLAT

DOGA RIGHE  
STRIPED SLAT

DOGA QUADRO LEGNO  
WOODEN SQUARE SLAT

**+ 67**

**+ 97**

**OPTIONAL**  
**OPTIONAL**

**KIT SPORTELLINO PASSACAVI  
+ BORCHIA**  
KIT FOR CABLE MANAGEMENT HOLE  
+ COVER

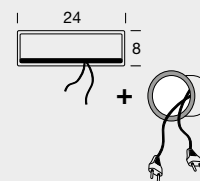

**ZZZFE22005**

**133**

1 CESTONE  
1 BASKET

**NEW**

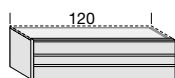

**SHC1021K**

**1.077**  
**+ 5 %**

mc 0,18 – Kg 18

1 RIBALTA  
1 DROP-DOWN DOOR

**NEW**

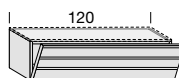

**SHC1061K**

**1.089**  
**+ 5 %**

mc 0,18 – Kg 15

1 CESTONE  
1 BASKET

**NEW**

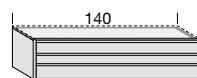

**SHC1031K**

**1.167**  
**+ 5 %**

mc 0,21 – Kg 20

1 RIBALTA  
1 DROP-DOWN DOOR

**NEW**

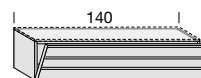

**SHC1071K**

**1.221**  
**+ 5 %**

mc 0,21 – Kg 17

1 RIBALTA  
1 DROP-DOWN DOOR

**OPTIONAL**

DOGA RIGHE  
STRIPED SLAT

**+ 67**

DOGA SLAT  
DOGA QUADRO LEGNO  
WOODEN SQUARE SLAT

**+ 97**



**DOC1101K**

**722**  
**+ 5 %**

mc 0,07 – Kg 9

1 RIBALTA  
1 DROP-DOWN DOOR



DOGA LEGNO LISCIA  
PLAIN WOODEN SLAT

**DOC1106K**

**962**  
**+ 5 %**

mc 0,07 – Kg 9

**OPTIONAL**

DOGA RIGHE  
STRIPED SLAT

**+ 67**

DOGA SLAT  
DOGA QUADRO LEGNO  
WOODEN SQUARE SLAT

**+ 97**

1 RIBALTA  
1 DROP-DOWN DOOR

**OPTIONAL**

DOGA RIGHE  
STRIPED SLAT

**+ 67**

DOGA SLAT  
DOGA QUADRO LEGNO  
WOODEN SQUARE SLAT

**+ 97**

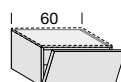

**DOC1131K**

**813**  
**+ 5 %**

mc 0,11 – Kg 11

1 RIBALTA  
1 DROP-DOWN DOOR

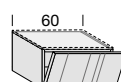

DOGA LEGNO LISCIA  
PLAIN WOODEN SLAT

**DOC1136K**

**1.064**  
**+ 5 %**

mc 0,11 – Kg 11

**OPTIONAL**

DOGA RIGHE  
STRIPED SLAT

**+ 67**

DOGA SLAT  
DOGA QUADRO LEGNO  
WOODEN SQUARE SLAT

**+ 97**

# SISTEMA COMPONIBILE - MODULAR SYSTEM

## BASI A TERRA P. 48

### FLOOR-STANDING BASE UNITS D. 48

#### BASI H. 35 BASE UNITS H. 35

A GIORNO  
OPEN

A GIORNO, 1 RIPIANO VETRO  
OPEN ON PLATFORM, 1 GLASS SHELF

1 CESTONE  
1 BASKET

1 CESTONE  
1 BASKET

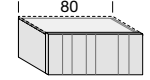
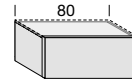
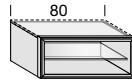
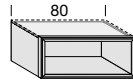

**OBBLIGATORIO: AGGIUNGERE TOP E PEDANA O ZOCCOLO A TERRA.**  
**COMPULSORY: ADD TOP AND PLATFORM OR PLINTH ON FLOOR.**

**DOC1231K**

**DOC1281K**

**DOC1041K**

DOGA LEGNO LISCIA  
PLAIN WOODEN SLAT

**DOC1046K**

CANALETTO

Doghe Multicolor - Multicolor slats

**735**

**770**

**909**  
**+ 5 %**

**1.160**  
**+ 5 %**

mc 0,15 - Kg 10

mc 0,15 - Kg 10

mc 0,15 - Kg 18

mc 0,15 - Kg 18

A GIORNO  
OPEN

A GIORNO, 1 RIPIANO VETRO  
OPEN ON PLATFORM, 1 GLASS SHELF

1 CESTONE  
1 BASKET

1 CESTONE  
1 BASKET

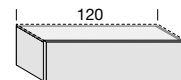
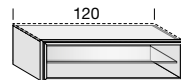
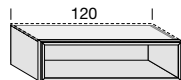

**OBBLIGATORIO: AGGIUNGERE TOP E PEDANA O ZOCCOLO A TERRA.**  
**COMPULSORY: ADD TOP AND PLATFORM OR PLINTH ON FLOOR.**

**DOC1241K**

**DOC1291K**

**DOC1061K**

DOGA LEGNO LISCIA  
PLAIN WOODEN SLAT

**DOC1066K**

CANALETTO

Doghe Multicolor - Multicolor slats

**854**

**914**

**1.059**  
**+ 5 %**

**1.353**  
**+ 5 %**

mc 0,22 - Kg 14

mc 0,22 - Kg 14

mc 0,22 - Kg 21

mc 0,22 - Kg 21

A GIORNO  
OPEN

A GIORNO, 1 RIPIANO VETRO  
OPEN ON PLATFORM,  
1 GLASS SHELF

A GIORNO, 3 DIVISORI  
OPEN, 3 PARTITIONS

1 CESTONE  
1 BASKET

1 CESTONE  
1 BASKET

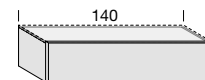
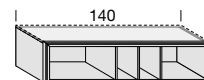
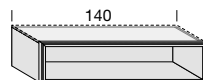

**OBBLIGATORIO: AGGIUNGERE TOP E PEDANA O ZOCCOLO A TERRA.**  
**COMPULSORY: ADD TOP AND PLATFORM OR PLINTH ON FLOOR.**

**DOC1251K**

**DOC1301K**

**DOC1621K**

**DOC1081K**

DOGA LEGNO LISCIA  
PLAIN WOODEN SLAT

**DOC1086K**

CANALETTO

Doghe Multicolor - Multicolor slats

**938**

**884**

**1.155**

**1.167**  
**+ 5 %**

**1.432**  
**+ 5 %**

mc 0,26 - Kg 18

mc 0,26 - Kg 18

mc 0,21 - Kg 15

mc 0,26 - Kg 23

mc 0,26 - Kg 23

#### SHANGHAI BASI H. 35 SHANGHAI BASE UNITS H. 35

1 CESTONE  
1 BASKET

1 RIBALTA  
1 DROP-DOWN DOOR

1 CESTONE  
1 BASKET

1 RIBALTA  
1 DROP-DOWN DOOR

**NEW**

**NEW**

**NEW**

**NEW**

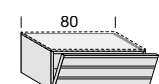
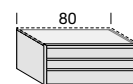
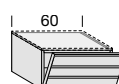
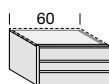

**OBBLIGATORIO: AGGIUNGERE TOP E PEDANA O ZOCCOLO A TERRA.**  
**COMPULSORY: ADD TOP AND PLATFORM OR PLINTH ON FLOOR.**

**SHC1081K**

**SHC1121K**

**SHC1091K**

**SHC1131K**

CANALETTO

Bicolore - Bicolor

**879**  
**+ 5 %**

**920**  
**+ 5 %**

**968**  
**+ 5 %**

**1.004**  
**+ 5 %**

mc 0,09 - Kg 12

mc 0,09 - Kg 10

mc 0,12 - Kg 16

mc 0,12 - Kg 8

1 RIBALTA  
1 DROP-DOWN DOOR

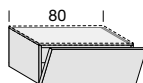

1 RIBALTA  
1 DROP-DOWN DOOR

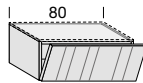

DOGA LEGNO LISCIA  
PLAIN WOODEN SLAT

DOC1156K

1.179  
+ 5 %

mc 0,15 - Kg 13

OPTIONAL

DOGA SLAT

DOGA RIGHE  
STRIPED SLAT

DOGA QUADRO LEGNO  
WOODEN SQUARE SLAT

+ 67

+ 97

DOC1151K

896

+ 5 %

mc 0,15 - Kg 13

OPTIONAL

DOGA SLAT

DOGA RIGHE  
STRIPED SLAT

DOGA QUADRO LEGNO  
WOODEN SQUARE SLAT

+ 67

+ 97

OPTIONAL  
OPTIONAL

KIT SPORTELLINO PASSACAVI  
+ BORCHIA  
KIT FOR CABLE MANAGEMENT HOLE  
+ COVER

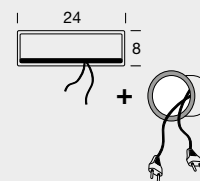

ZZZFE22005

133

1 RIBALTA  
1 DROP-DOWN DOOR

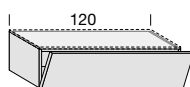

1 RIBALTA  
1 DROP-DOWN DOOR

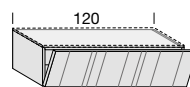

DOGA LEGNO LISCIA  
PLAIN WOODEN SLAT

DOC1176K

1.341  
+ 5 %

mc 0,22 - Kg 16

OPTIONAL

DOGA SLAT

DOGA RIGHE  
STRIPED SLAT

DOGA QUADRO LEGNO  
WOODEN SQUARE SLAT

+ 67

+ 97

DOC1171K

1.023

+ 5 %

mc 0,22 - Kg 16

OPTIONAL

DOGA SLAT

DOGA RIGHE  
STRIPED SLAT

DOGA QUADRO LEGNO  
WOODEN SQUARE SLAT

+ 67

+ 97

1 RIBALTA  
1 DROP-DOWN DOOR

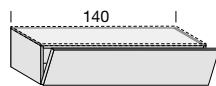

1 RIBALTA  
1 DROP-DOWN DOOR

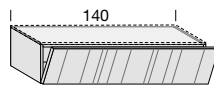

DOGA LEGNO LISCIA  
PLAIN WOODEN SLAT

DOC1196K

1.461  
+ 5 %

mc 0,26 - Kg 18

OPTIONAL

DOGA SLAT

DOGA RIGHE  
STRIPED SLAT

DOGA QUADRO LEGNO  
WOODEN SQUARE SLAT

+ 55

+ 80

DOC1191K

1.179

+ 5 %

mc 0,26 - Kg 18

OPTIONAL

DOGA SLAT

DOGA RIGHE  
STRIPED SLAT

DOGA QUADRO LEGNO  
WOODEN SQUARE SLAT

+ 67

+ 97

1 CESTONE  
1 BASKET

NEW

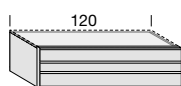

SHC1101K

1.089

+ 5 %

mc 0,18 - Kg 18

1 RIBALTA  
1 DROP-DOWN DOOR

NEW

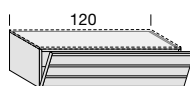

SHC1141K

1.112

+ 5 %

mc 0,18 - Kg 15

1 CESTONE  
1 BASKET

NEW

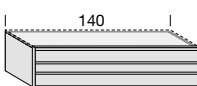

SHC1111K

1.179

+ 5 %

mc 0,21 - Kg 20

1 RIBALTA  
1 DROP-DOWN DOOR

NEW

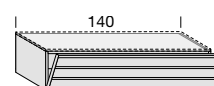

SHC1151K

1.250

+ 5 %

mc 0,21 - Kg 17

# SISTEMA COMPONIBILE - MODULAR SYSTEM

## BASI SOSPENSE P. 38

### SUSPENDED BASE UNITS D. 38

#### BASI H. 35 BASE UNITS H. 35

A GIORNO  
OPEN

A GIORNO, 1 RIPIANO VETRO  
OPEN ON PLATFORM, 1 GLASS SHELF

1 CESTONE  
1 BASKET

1 CESTONE  
1 BASKET

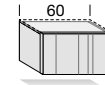
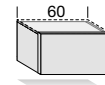
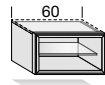
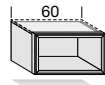

**OBBLIGATORIO: AGGIUNGERE TOP E PEDANA O ZOCCOLO A TERRA.  
COMPULSORY: ADD TOP AND PLATFORM OR PLINTH ON FLOOR.**

**DOC1522K**

**DOC1572K**

**DOC1341K**

DOGA LEGNO LISCIA  
PLAIN WOODEN SLAT

**DOC1346K**

CANALETTO

**650**

**686**

**800**

**1.041**

Doghe Multicolor - Multicolor slats

mc 0,09 - Kg 7

mc 0,09 - Kg 7

**+ 5 %**  
mc 0,09 - Kg 12

**+ 5 %**  
mc 0,09 - Kg 12

A GIORNO  
OPEN

A GIORNO, 1 RIPIANO VETRO  
OPEN ON PLATFORM, 1 GLASS SHELF

1 CESTONE  
1 BASKET

1 CESTONE  
1 BASKET

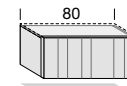
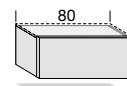
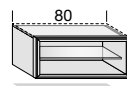
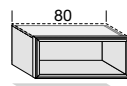

**OBBLIGATORIO: AGGIUNGERE TOP E PEDANA O ZOCCOLO A TERRA.  
COMPULSORY: ADD TOP AND PLATFORM OR PLINTH ON FLOOR.**

**DOC1532K**

**DOC1582K**

**DOC1361K**

DOGA LEGNO LISCIA  
PLAIN WOODEN SLAT

**DOC1366K**

CANALETTO

**740**

**783**

**914**

**1.167**

Doghe Multicolor - Multicolor slats

mc 0,12 - Kg 11

mc 0,12 - Kg 11

**+ 5 %**  
mc 0,12 - Kg 16

**+ 5 %**  
mc 0,12 - Kg 16

A GIORNO  
OPEN

A GIORNO, 1 RIPIANO VETRO  
OPEN ON PLATFORM, 1 GLASS SHELF

1 CESTONE  
1 BASKET

1 CESTONE  
1 BASKET

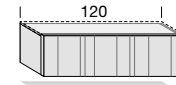
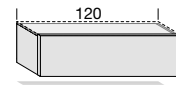
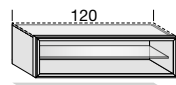
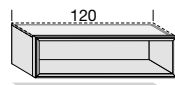

**OBBLIGATORIO: AGGIUNGERE TOP E PEDANA O ZOCCOLO A TERRA.  
COMPULSORY: ADD TOP AND PLATFORM OR PLINTH ON FLOOR.**

**DOC1542K**

**DOC1592K**

**DOC1381K**

DOGA LEGNO LISCIA  
PLAIN WOODEN SLAT

**DOC1386K**

CANALETTO

**854**

**920**

**1.059**

**1.353**

Doghe Multicolor - Multicolor slats

mc 0,18 - Kg 14

mc 0,18 - Kg 14

**+ 5 %**  
mc 0,18 - Kg 18

**+ 5 %**  
mc 0,18 - Kg 18

A GIORNO  
OPEN

A GIORNO, 1 RIPIANO VETRO  
OPEN ON PLATFORM, 1 GLASS SHELF

A GIORNO, 3 DIVISORI  
OPEN, 3 PARTITIONS

1 CESTONE  
1 BASKET

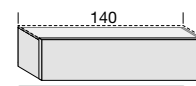
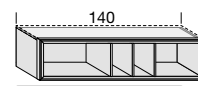
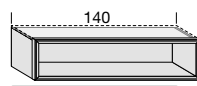

**OBBLIGATORIO: AGGIUNGERE TOP E PEDANA O ZOCCOLO A TERRA.  
COMPULSORY: ADD TOP AND PLATFORM OR PLINTH ON FLOOR.**

**DOC1552K**

**DOC1602K**

**DOC1612K**

**DOC1401K**

CANALETTO

**944**

**1.011**

**1.149**

**1.160**

Doghe Multicolor - Multicolor slats

mc 0,21 - Kg 15

mc 0,21 - Kg 15

**+ 5 %**  
mc 0,21 - Kg 15

**+ 5 %**  
mc 0,21 - Kg 20



1 RIBALTA  
1 DROP-DOWN DOOR

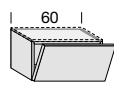

1 RIBALTA  
1 DROP-DOWN DOOR

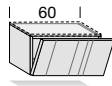

DOGA LEGNO LISCIA  
PLAIN WOODEN SLAT

OPTIONAL	
DOGA SLAT	DOGA SLAT
DOGA RIGHE STRIPED SLAT	DOGA QUADRO LEGNO WOODEN SQUARE SLAT
+ 67	+ 97

DOC1441K
813
+ 5 %
mc 0,09 – Kg 10

DOC1446K
1.064
+ 5 %
mc 0,09 – Kg 10

OPTIONAL	
DOGA SLAT	DOGA SLAT
DOGA RIGHE STRIPED SLAT	DOGA QUADRO LEGNO WOODEN SQUARE SLAT
+ 67	+ 97

OPTIONAL  
OPTIONAL

KIT SPORTELLINO PASSACAVI  
+ BORCHIA  
KIT FOR CABLE MANAGEMENT HOLE  
+ COVER

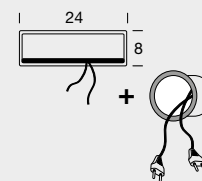

ZZZFE22005  
133

1 RIBALTA  
1 DROP-DOWN DOOR

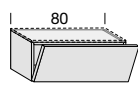

1 RIBALTA  
1 DROP-DOWN DOOR

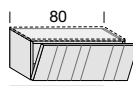

DOGA LEGNO LISCIA  
PLAIN WOODEN SLAT

OPTIONAL	
DOGA SLAT	DOGA SLAT
DOGA RIGHE STRIPED SLAT	DOGA QUADRO LEGNO WOODEN SQUARE SLAT
+ 67	+ 97

DOC1461K
903
+ 5 %
mc 0,12 – Kg 12

DOC1466K
1.184
+ 5 %
mc 0,12 – Kg 12

OPTIONAL	
DOGA SLAT	DOGA SLAT
DOGA RIGHE STRIPED SLAT	DOGA QUADRO LEGNO WOODEN SQUARE SLAT
+ 67	+ 97

1 RIBALTA  
1 DROP-DOWN DOOR

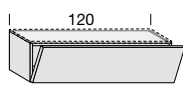

1 RIBALTA  
1 DROP-DOWN DOOR

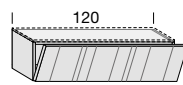

DOGA LEGNO LISCIA  
PLAIN WOODEN SLAT

OPTIONAL	
DOGA SLAT	DOGA SLAT
DOGA RIGHE STRIPED SLAT	DOGA QUADRO LEGNO WOODEN SQUARE SLAT
+ 67	+ 97

DOC1481K
1.023
+ 5 %
mc 0,18 – Kg 15

DOC1486K
1.341
+ 5 %
mc 0,18 – Kg 15

OPTIONAL	
DOGA SLAT	DOGA SLAT
DOGA RIGHE STRIPED SLAT	DOGA QUADRO LEGNO WOODEN SQUARE SLAT
+ 67	+ 97

1 CESTONE  
1 BASKET

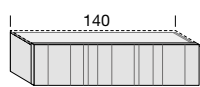

1 RIBALTA  
1 DROP-DOWN DOOR

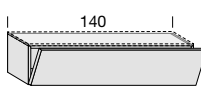

1 RIBALTA  
1 DROP-DOWN DOOR

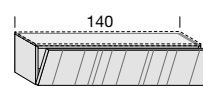

DOGA LEGNO LISCIA  
PLAIN WOODEN SLAT

DOC1406K
1.419
+ 5 %
mc 0,21 – Kg 20

OPTIONAL	
DOGA SLAT	DOGA SLAT
DOGA RIGHE STRIPED SLAT	DOGA QUADRO LEGNO WOODEN SQUARE SLAT
+ 67	+ 97

DOC1501K
1.173
+ 5 %
mc 0,21 – Kg 17

DOGA LEGNO LISCIA  
PLAIN WOODEN SLAT

DOC1506K
1.456
+ 5 %
mc 0,21 – Kg 17

OPTIONAL	
DOGA SLAT	DOGA SLAT
DOGA RIGHE STRIPED SLAT	DOGA QUADRO LEGNO WOODEN SQUARE SLAT
+ 67	+ 97

# SISTEMA COMPONIBILE - MODULAR SYSTEM

## BASI SOSPESSE P. 38

### SUSPENDED BASE UNITS D. 38

**SHANGHAI**  
BASI H. 35  
SHANGHAI  
BASE UNITS H. 35

1 CESTONE  
1 BASKET

**NEW**

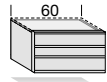

**SHC1161K**

**879**  
**+ 5 %**

mc 0,09 – Kg 12

1 RIBALTA  
1 DROP-DOWN DOOR

**NEW**

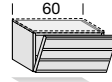

**SHC1201K**

**914**  
**+ 5 %**

mc 0,09 – Kg 10

1 CESTONE  
1 BASKET

**NEW**

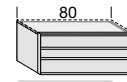

**SHC1171K**

**968**  
**+ 5 %**

mc 0,12 – Kg 16

1 RIBALTA  
1 DROP-DOWN DOOR

**NEW**

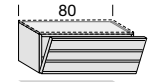

**SHC1211K**

**1.004**  
**+ 5 %**

mc 0,12 – Kg 8

**OBBLIGATORIO: AGGIUNGERE TOP E PEDANA O ZOCCOLO A TERRA.**  
**COMPULSORY: ADD TOP AND PLATFORM OR PLINTH ON FLOOR.**

CANALETTO  
Bicolore - Bicolor

## BASI SOSPESSE P. 48

### SUSPENDED

### BASE UNITS D. 48

**BASI H. 35**  
BASE UNITS H. 35

A GIORNO  
OPEN

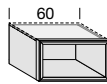

**DOC1222K**

**662**

mc 0,11 – Kg 8

A GIORNO, 1 RIPIANO VETRO  
OPEN ON PLATFORM, 1 GLASS SHELF

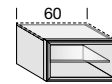

**DOC1272K**

**698**

mc 0,11 – Kg 8

1 CESTONE  
1 BASKET

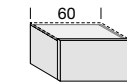

**DOC1031K**

**813**  
**+ 5 %**

mc 0,11 – Kg 15

1 CESTONE  
1 BASKET

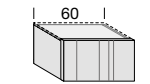

DOGA LEGNO LISCIA  
PLAIN WOODEN SLAT

**DOC1036K**

**1.052**  
**+ 5 %**

mc 0,11 – Kg 15

**OBBLIGATORIO: AGGIUNGERE TOP E PEDANA O ZOCCOLO A TERRA.**  
**COMPULSORY: ADD TOP AND PLATFORM OR PLINTH ON FLOOR.**

CANALETTO  
Doghe Multicolor - Multicolor slats

A GIORNO  
OPEN

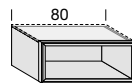

**DOC1232K**

**746**

mc 0,15 – Kg 10

A GIORNO, 1 RIPIANO VETRO  
OPEN ON PLATFORM, 1 GLASS SHELF

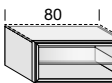

**DOC1282K**

**788**

mc 0,15 – Kg 10

1 CESTONE  
1 BASKET

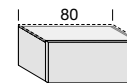

**DOC1051K**

**920**  
**+ 5 %**

mc 0,15 – Kg 18

1 CESTONE  
1 BASKET

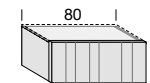

DOGA LEGNO LISCIA  
PLAIN WOODEN SLAT

**DOC1056K**

**1.173**  
**+ 5 %**

mc 0,15 – Kg 18

**OBBLIGATORIO: AGGIUNGERE TOP E PEDANA O ZOCCOLO A TERRA.**  
**COMPULSORY: ADD TOP AND PLATFORM OR PLINTH ON FLOOR.**

CANALETTO  
Doghe Multicolor - Multicolor slats

A GIORNO  
OPEN

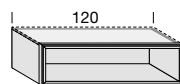

**DOC1242K**

**866**

mc 0,22 – Kg 14

A GIORNO, 1 RIPIANO VETRO  
OPEN ON PLATFORM, 1 GLASS SHELF

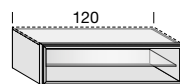

**DOC1292K**

**932**

mc 0,22 – Kg 14

1 CESTONE  
1 BASKET

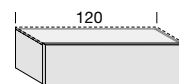

**DOC1071K**

**1.070**  
**+ 5 %**

mc 0,22 – Kg 21

1 CESTONE  
1 BASKET

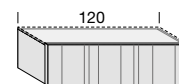

DOGA LEGNO LISCIA  
PLAIN WOODEN SLAT

**DOC1076K**

**1.365**  
**+ 5 %**

mc 0,22 – Kg 21

**OBBLIGATORIO: AGGIUNGERE TOP E PEDANA O ZOCCOLO A TERRA.**  
**COMPULSORY: ADD TOP AND PLATFORM OR PLINTH ON FLOOR.**

CANALETTO  
Doghe Multicolor - Multicolor slats

1 CESTONE  
1 BASKET

**NEW**

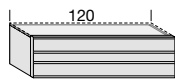

**SHC1181K**

**1.089**  
**+ 5 %**

mc 0,18 – Kg 18

1 RIBALTA  
1 DROP-DOWN DOOR

**NEW**

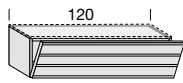

**SHC1221K**

**1.100**  
**+ 5 %**

mc 0,18 – Kg 15

1 CESTONE  
1 BASKET

**NEW**

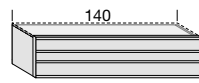

**SHC1191K**

**1.179**  
**+ 5 %**

mc 0,21 – Kg 20

1 RIBALTA  
1 DROP-DOWN DOOR

**NEW**

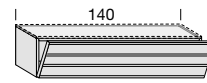

**SHC1231K**

**1.240**  
**+ 5 %**

mc 0,21 – Kg 17

1 RIBALTA  
1 DROP-DOWN DOOR

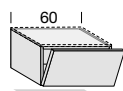

**DOC1141K**

**823**  
**+ 5 %**

mc 0,11 – Kg 11

1 RIBALTA  
1 DROP-DOWN DOOR

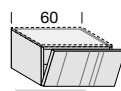

DOGA LEGNO LISCIA  
PLAIN WOODEN SLAT

**DOC1146K**

**1.077**  
**+ 5 %**

mc 0,11 – Kg 11

**OPTIONAL**

DOGA SLAT

DOGA RIGHE STRIPED SLAT DOGA QUADRO LEGNO WOODEN SQUARE SLAT

**+ 67** **+ 97**

1 RIBALTA  
1 DROP-DOWN DOOR

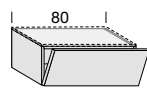

**DOC1161K**

**909**  
**+ 5 %**

mc 0,15 – Kg 13

1 RIBALTA  
1 DROP-DOWN DOOR

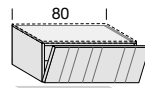

DOGA LEGNO LISCIA  
PLAIN WOODEN SLAT

**DOC1166K**

**1.191**  
**+ 5 %**

mc 0,15 – Kg 13

**OPTIONAL**

DOGA SLAT

DOGA RIGHE STRIPED SLAT DOGA QUADRO LEGNO WOODEN SQUARE SLAT

**+ 67** **+ 97**

1 RIBALTA  
1 DROP-DOWN DOOR

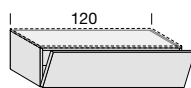

**DOC1181K**

**1.034**  
**+ 5 %**

mc 0,22 – Kg 16

1 RIBALTA  
1 DROP-DOWN DOOR

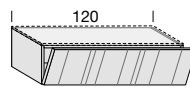

DOGA LEGNO LISCIA  
PLAIN WOODEN SLAT

**DOC1186K**

**1.353**  
**+ 5 %**

mc 0,22 – Kg 16

**OPTIONAL**

DOGA SLAT

DOGA RIGHE STRIPED SLAT DOGA QUADRO LEGNO WOODEN SQUARE SLAT

**+ 67** **+ 97**

# SISTEMA COMPONIBILE - MODULAR SYSTEM

## BASI SOSPESE P. 48

### SUSPENDED BASE UNITS D. 48

#### BASI H. 35 BASE UNITS H. 35

A GIORNO  
OPEN

A GIORNO, 1 RIPIANO VETRO  
OPEN ON PLATFORM, 1 GLASS SHELF

A GIORNO, 3 DIVISORI  
OPEN, 3 PARTITIONS

1 CESTONE  
1 BASKET

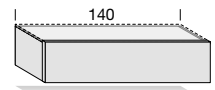
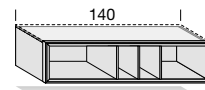
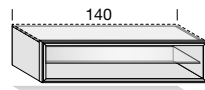
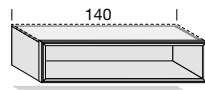

**OBBLIGATORIO: AGGIUNGERE TOP E PEDANA O ZOCCOLO A TERRA.**  
**COMPULSORY: ADD TOP AND PLATFORM OR PLINTH ON FLOOR.**

**DOC1252K**

**DOC1302K**

**DOC1622K**

**DOC1091K**

CANALETTO

**951**

**1.023**

**1.167**

**1.179**

Doghe Multicolor - Multicolor slats

mc 0,26 - Kg 18

mc 0,26 - Kg 18

mc 0,21 - Kg 15

**+ 5 %**  
mc 0,26 - Kg 23

#### SHANGHAI BASI H. 35 SHANGHAI BASE UNITS H. 35

1 CESTONE  
1 BASKET

1 RIBALTA  
1 DROP-DOWN DOOR

1 CESTONE  
1 BASKET

1 RIBALTA  
1 DROP-DOWN DOOR

**NEW**

**NEW**

**NEW**

**NEW**

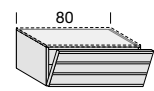
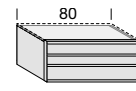
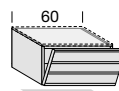
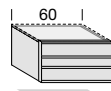

**OBBLIGATORIO: AGGIUNGERE TOP E PEDANA O ZOCCOLO A TERRA.**  
**COMPULSORY: ADD TOP AND PLATFORM OR PLINTH ON FLOOR.**

**SHC1241K**

**SHC1281K**

**SHC1251K**

**SHC1291K**

CANALETTO

**890**

**938**

**981**

**1.016**

Bicolore - Bicolor

**+ 5 %**

**+ 5 %**

**+ 5 %**

**+ 5 %**

mc 0,09 - Kg 12

mc 0,09 - Kg 10

mc 0,12 - Kg 16

mc 0,12 - Kg 8

1 CESTONE  
1 BASKET

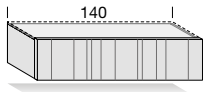

DOGA LEGNO LISCIA  
PLAIN WOODEN SLAT

DOC1096K	OPTIONAL	
	DOGA SLAT	
	DOGA RIGHE STRIPED SLAT	DOGA QUADRO LEGNO WOODEN SQUARE SLAT
<b>1.443</b>	<b>+ 67</b>	<b>+ 97</b>
<b>+ 5 %</b>		
mc 0,26 - Kg 23		

1 RIBALTA  
1 DROP-DOWN DOOR

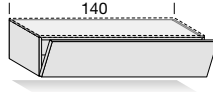

DOC1201K
<b>1.191</b>
<b>+ 5 %</b>
mc 0,26 - Kg 18

1 RIBALTA  
1 DROP-DOWN DOOR

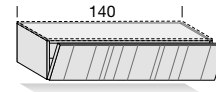

DOGA LEGNO LISCIA  
PLAIN WOODEN SLAT

DOC1206K	OPTIONAL	
	DOGA SLAT	
	DOGA RIGHE STRIPED SLAT	DOGA QUADRO LEGNO WOODEN SQUARE SLAT
<b>1.509</b>	<b>+ 67</b>	<b>+ 97</b>
<b>+ 5 %</b>		
mc 0,26 - Kg 18		

1 CESTONE  
1 BASKET

**NEW**

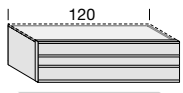

SHC1261K
<b>1.100</b>
<b>+ 5 %</b>
mc 0,18 - Kg 18

1 RIBALTA  
1 DROP-DOWN DOOR

**NEW**

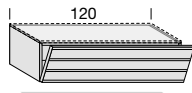

SHC1301K
<b>1.125</b>
<b>+ 5 %</b>
mc 0,18 - Kg 15

1 CESTONE  
1 BASKET

**NEW**

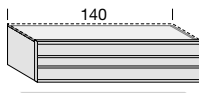

SHC1271K
<b>1.191</b>
<b>+ 5 %</b>
mc 0,21 - Kg 20

1 RIBALTA  
1 DROP-DOWN DOOR

**NEW**

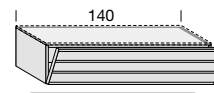

SHC1311K
<b>1.263</b>
<b>+ 5 %</b>
mc 0,21 - Kg 17

**OPTIONAL**  
**OPTIONAL**

KIT SPORTELO PASSACAVI  
+ BORCHIA  
KIT FOR CABLE MANAGEMENT HOLE  
+ COVER

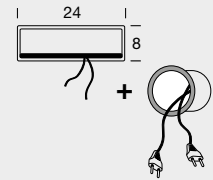

**ZZZFE22005**

**133**

# DOMINO SISTEMA COMPONIBILE - MODULAR SYSTEM

## PENSILI ORIZZONTALI P. 38

### HORIZONTAL WALL UNITS D. 38

**PENSILI H. 35**  
WALL UNITS H. 35

1 ANTA RIBALTA  
1 DROP-DOWN DOOR

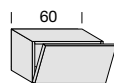

**DOC2051K**

**783**  
**+ 10 %**  
mc 0,09 – Kg 12

1 ANTA VASISTAS  
1 LIFT-UP DOOR

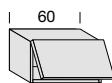

**DOC2071K**

**735**  
**+ 5 %**  
mc 0,09 – Kg 12

1 ANTA VETRO RIBALTA  
1 DROP-DOWN GLASS DOOR

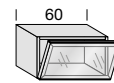

VETRO TRASPARENTE  
TRANSPARENT GLASS

**DOC2041K**

**896**  
**+ 5 %**  
mc 0,09 – Kg 12

**OPTIONAL**

VETRO GLASS  
TOP SOL FUMÉ SMOKED  
**+ 37** **+ 19**

CANALETTO  
Multicolor

1 ANTA DOGATA VASISTAS  
1 SLATTED LIFT-UP DOOR

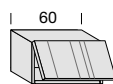

DOGA LEGNO LISCIA  
PLAIN WOODEN SLAT

**DOC2076K**

**975**  
**+ 5 %**  
mc 0,09 – Kg 12

**OPTIONAL**

DOGA SLAT  
DOGA RIGHE STRIPED SLAT DOGA QUADRO LEGNO WOODEN SQUARE SLAT  
**+ 67** **+ 97**

1 ANTA LEGNO RIBALTA  
1 DROP-DOWN DOOR

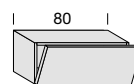

**DOC2091K**

**890**  
**+ 5 %**  
mc 0,12 – Kg 15

1 ANTA LEGNO VASISTAS  
1 LIFT-UP DOOR

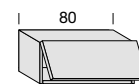

**DOC2111K**

**884**  
**+ 5 %**  
mc 0,12 – Kg 15

CANALETTO  
Multicolor

1 ANTA DOGATA RIBALTA  
1 SLATTED DROP-DOWN DOOR

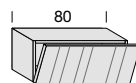

DOGA LEGNO LISCIA  
PLAIN WOODEN SLAT

**DOC2096K**

**1.167**  
**+ 5 %**  
mc 0,12 – Kg 15

**OPTIONAL**

DOGA SLAT  
DOGA RIGHE STRIPED SLAT DOGA QUADRO LEGNO WOODEN SQUARE SLAT  
**+ 67** **+ 97**

1 ANTA DOGATA VASISTAS  
1 SLATTED LIFT-UP DOOR

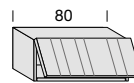

DOGA LEGNO LISCIA  
PLAIN WOODEN SLAT

**DOC2116K**

**1.160**  
**+ 5 %**  
mc 0,12 – Kg 15

**OPTIONAL**

DOGA SLAT  
DOGA RIGHE STRIPED SLAT DOGA QUADRO LEGNO WOODEN SQUARE SLAT  
**+ 67** **+ 97**

CANALETTO  
Multicolor

1 ANTA VETRO VASISTAS  
1 GLASS LIFT-UP DOOR

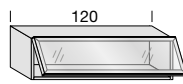

VETRO TRASPARENTE  
TRANSPARENT GLASS

**DOC2141K**

**1.197**  
**+ 5 %**  
mc 0,18 – Kg 21

**OPTIONAL**

VETRO GLASS  
TOP SOL FUMÉ SMOKED  
**+ 79** **+ 30**

1 ANTA DOGATA RIBALTA  
1 SLATTED DROP-DOWN DOOR

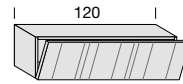

DOGA LEGNO LISCIA  
PLAIN WOODEN SLAT

**DOC2136K**

**1.419**  
**+ 5 %**  
mc 0,18 – Kg 21

**OPTIONAL**

DOGA SLAT  
DOGA RIGHE STRIPED SLAT DOGA QUADRO LEGNO WOODEN SQUARE SLAT  
**+ 67** **+ 97**

CANALETTO  
Multicolor

1 ANTA VETRO VASISTAS  
1 GLASS LIFT-UP DOOR

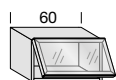

VETRO TRASPARENTE  
TRANSPARENT GLASS

DOC2061K	OPTIONAL	
	VETRO GLASS	
	TOP SOL	FUMÉ SMOKED
<b>848</b>	<b>+ 37</b>	<b>+ 19</b>
<b>+ 5 %</b>		
mc 0,09 – Kg 12		

1 ANTA DOGATA RIBALTA  
1 SLATTED DROP-DOWN DOOR

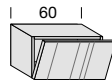

DOGA LEGNO LISCIA  
PLAIN WOODEN SLAT

DOC2056K	OPTIONAL	
	DOGA SLAT	
	DOGA RICHE STRIPED SLAT	DOGA QUADRO LEGNO WOODEN SQUARE SLAT
<b>1.016</b>	<b>+ 67</b>	<b>+ 97</b>
<b>+ 5 %</b>		
mc 0,09 – Kg 12		

1 ANTA VETRO RIBALTA  
1 DROP-DOWN GLASS DOOR

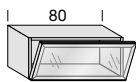

VETRO TRASPARENTE  
TRANSPARENT GLASS

DOC2081K	OPTIONAL	
	VETRO GLASS	
	TOP SOL	FUMÉ SMOKED
<b>981</b>	<b>+ 54</b>	<b>+ 24</b>
<b>+ 5 %</b>		
mc 0,12 – Kg 15		

1 ANTA VETRO VASISTAS  
1 GLASS LIFT-UP DOOR

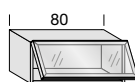

VETRO TRASPARENTE  
TRANSPARENT GLASS

DOC2101K	OPTIONAL	
	VETRO GLASS	
	TOP SOL	FUMÉ SMOKED
<b>975</b>	<b>+ 54</b>	<b>+ 24</b>
<b>+ 5 %</b>		
mc 0,12 – Kg 15		

1 ANTA LEGNO RIBALTA  
1 DROP-DOWN DOOR

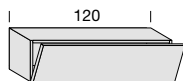

DOC2131K
<b>1.052</b>
<b>+ 5 %</b>
mc 0,18 – Kg 21

1 ANTA LEGNO VASISTAS  
1 LIFT-UP DOOR

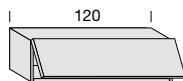

DOC2151K
<b>1.047</b>
<b>+ 5 %</b>
mc 0,18 – Kg 21

1 ANTA VETRO RIBALTA  
1 DROP-DOWN GLASS DOOR

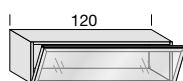

VETRO TRASPARENTE  
TRANSPARENT GLASS

DOC2121K	OPTIONAL	
	VETRO GLASS	
	TOP SOL	FUMÉ SMOKED
<b>1.209</b>	<b>+ 79</b>	<b>+ 30</b>
<b>+ 5 %</b>		
mc 0,18 – Kg 21		

1 ANTA DOGATA VASISTAS  
1 SLATTED LIFT-UP DOOR

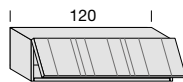

DOGA LEGNO LISCIA  
PLAIN WOODEN SLAT

DOC2156K	OPTIONAL	
	DOGA SLAT	
	DOGA RICHE STRIPED SLAT	DOGA QUADRO LEGNO WOODEN SQUARE SLAT
<b>1.413</b>	<b>+ 67</b>	<b>+ 97</b>
<b>+ 5 %</b>		
mc 0,18 – Kg 21		

1 ANTA LEGNO RIBALTA  
1 DROP-DOWN DOOR

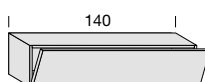

DOC2171K
<b>1.197</b>
<b>+ 5 %</b>
mc 0,21 – Kg 24

1 ANTA LEGNO VASISTAS  
1 LIFT-UP DOOR

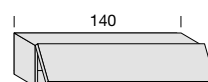

DOC2191K
<b>1.119</b>
<b>+ 5 %</b>
mc 0,21 – Kg 24

OPTIONAL  
OPTIONAL

BARRA LED A BASSO CONSUMO  
ACCENSIONE TOUCH IN ALLUMINIO  
DA POSIZIONARE SUL COPERCHIO  
DEL PENSILE

LOW CONSUMPTION ALUMINIUM LED  
BAR WITH TOUCH SWITCH ON  
TO ARRANGE ON WALL UNIT TOP



ZZZFE22020

L. W. 40

**163**

ZZZFE22024

L. W. 60

**175**

ZZZFE22025

L. W. 80

**187**

ZZZFE22026

L. W. 120

**235**

ZZZFE22027

L. W. 140

**253**

ALIMENTATORE  
POWER SUPPLY



ZZZFE22002

**67**

COLLEGAMENTO  
A CARICO DEL CLIENTE  
CONNECTIONS  
TO BE MADE BY THE CUSTOMER.

# DOMINO SISTEMA COMPONIBILE - MODULAR SYSTEM

## PENSILI ORIZZONTALI P. 38

### HORIZONTAL WALL UNITS D. 38

#### PENSILI H. 35 WALL UNITS H. 35

1 ANTA VETRO RIBALTA  
1 DROP-DOWN GLASS DOOR

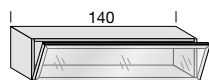

VETRO TRASPARENTE  
TRANSPARENT GLASS

DOC2161K	OPTIONAL	
	VETRO GLASS	
	TOP SOL	FUMÉ SMOKED
<b>1.401</b>	<b>+ 85</b>	<b>+ 37</b>
<b>+ 5 %</b>		
mc 0,21 – Kg 24		

1 ANTA VETRO VASISTAS  
1 GLASS LIFT-UP DOOR

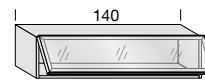

VETRO TRASPARENTE  
TRANSPARENT GLASS

DOC2181K	OPTIONAL	
	VETRO GLASS	
	TOP SOL	FUMÉ SMOKED
<b>1.323</b>	<b>+ 85</b>	<b>+ 37</b>
<b>+ 5 %</b>		
mc 0,21 – Kg 24		

CANALETTO  
Multicolor

#### PENSILI A GIORNO H. 35 CON CORNICE MASSELLO OPEN WALL UNITS H. 35 WITH SOLID FRAME

A GIORNO  
OPEN



DOC2751K
<b>524</b>
mc 0,06 – Kg 5

A GIORNO  
OPEN

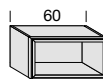

DOC2761K
<b>632</b>
mc 0,09 – Kg 7

A GIORNO  
OPEN

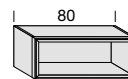

DOC2771K
<b>722</b>
mc 0,12 – Kg 11

A GIORNO  
OPEN

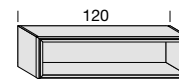

DOC2781K
<b>836</b>
mc 0,18 – Kg 14

A GIORNO, 1 RIPIANO VETRO  
OPEN, 1 GLASS SHELF



DOC2752K
<b>547</b>
mc 0,06 – Kg 5

A GIORNO, 1 RIPIANO VETRO  
OPEN, 1 GLASS SHELF

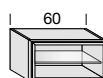

DOC2762K
<b>662</b>
mc 0,09 – Kg 7

A GIORNO, 1 RIPIANO VETRO  
OPEN, 1 GLASS SHELF

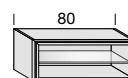

DOC2772K
<b>758</b>
mc 0,12 – Kg 11

A GIORNO, 1 RIPIANO VETRO  
OPEN, 1 GLASS SHELF

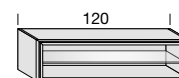

DOC2782K
<b>903</b>
mc 0,18 – Kg 15

#### PENSILI H. 35 WALL UNITS H. 35

1 ANTA LEGNO  
1 WOODEN DOOR

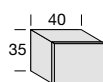

DX / RH  
SX / LH

DOC2481K DOC2581K
<b>625</b>
<b>+ 5 %</b>
mc 0,06 – Kg 9

1 ANTA VETRO  
1 GLASS DOOR

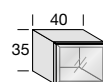

VETRO TRASPARENTE  
TRANSPARENT GLASS

DOC2471K DOC2571K	OPTIONAL	
	VETRO GLASS	
	TOP SOL	FUMÉ SMOKED
<b>740</b>	<b>+ 30</b>	<b>+ 19</b>
<b>+ 5 %</b>		
mc 0,06 – Kg 9		

1 ANTA DOGATA  
1 SLATTED DOOR

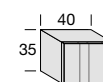

DOGA LEGNO LISCIA  
PLAIN WOODEN SLAT

DOC2486K DOC2586K
<b>842</b>
<b>+ 5 %</b>
mc 0,06 – Kg 9

CANALETTO  
Multicolor



1 ANTA DOGATA RIBALTA  
1 SLATTED DROP-DOWN DOOR

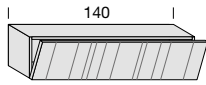

DOGA LEGNO LISCIA  
PLAIN WOODEN SLAT

DOC2176K	OPTIONAL	
	DOGA SLAT	
	DOGA RIGHE STRIPED SLAT	DOGA QUADRO LEGNO WOODEN SQUARE SLAT
<b>1.564</b>		
<b>+ 5 %</b>	<b>+ 67</b>	<b>+ 97</b>
mc 0,21 – Kg 24		

1 ANTA DOGATA VASISTAS  
1 SLATTED LIFT-UP DOOR

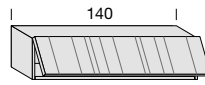

DOGA LEGNO LISCIA  
PLAIN WOODEN SLAT

DOC2196K	OPTIONAL	
	DOGA SLAT	
	DOGA RIGHE STRIPED SLAT	DOGA QUADRO LEGNO WOODEN SQUARE SLAT
<b>1.473</b>		
<b>+ 5 %</b>	<b>+ 67</b>	<b>+ 97</b>
mc 0,21 – Kg 24		

A GIORNO  
OPEN

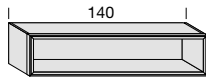

DOC2791K			
<b>914</b>			
mc 0,21 – Kg 15			

A GIORNO, 1 RIPIANO VETRO  
OPEN, 1 GLASS SHELF

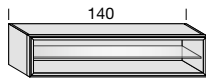

DOC2792K			
<b>981</b>			
mc 0,21 – Kg 16			

OPTIONAL  
OPTIONAL

BARRA LED A BASSO CONSUMO  
ACCENSIONE TOUCH IN ALLUMINIO  
DA POSIZIONARE SUL COPERCHIO  
DEL PENSILE

LOW CONSUMPTION ALUMINIUM LED  
BAR WITH TOUCH SWITCH ON  
TO ARRANGE ON WALL UNIT TOP



ZZZFE22020

L. W. 40

**163**

ZZZFE22024

L. W. 60

**175**

ZZZFE22025

L. W. 80

**187**

ZZZFE22026

L. W. 120

**235**

ZZZFE22027

L. W. 140

**253**

ALIMENTATORE  
POWER SUPPLY



ZZZFE22002

**67**

COLLEGAMENTO  
A CARICO DEL CLIENTE  
CONNECTIONS  
TO BE MADE BY THE CUSTOMER.

# DOMINO SISTEMA COMPONIBILE - MODULAR SYSTEM

## PENSILI ORIZZONTALI P. 38

### HORIZONTAL WALL UNITS D. 38

#### PENSILI H. 60 WALL UNITS H. 60

1 ANTA LEGNO, 1 RIPIANO VETRO  
1 WOODEN DOOR, 1 GLASS SHELF

1 ANTA VETRO, 1 RIPIANO VETRO  
1 GLASS DOOR, 1 GLASS SHELF

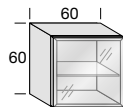
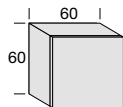

DX / RH  
SX / LH

**DOC2211K**  
**DOC2311K**

VETRO TRASPARENTE  
TRANSPARENT GLASS

**DOC2201K**  
**DOC2301K**

**OPTIONAL**

VETRO GLASS

TOP SOL

FUMÉ  
SMOKED

CANALETTO

**848**

**1.011**

**+ 54**

**+ 24**

Doghe Multicolor - Multicolor slats

**+ 5 %**

**+ 5 %**

mc 0,15 - Kg 20

mc 0,15 - Kg 20

2 ANTE LEGNO, 2 RIPIANI VETRO  
2 WOODEN DOORS, 2 GLASS SHELVES

2 ANTE VETRO, 2 RIPIANI VETRO  
2 GLASS SHELVES 1 GLASS SHELF

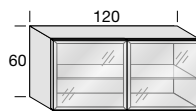
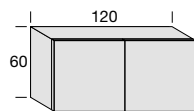

**DOC2231K**

**DOC2221K**

**OPTIONAL**

VETRO GLASS

TOP SOL

FUMÉ  
SMOKED

CANALETTO

**1.479**

**1.773**

**+ 102**

**+ 49**

Doghe Multicolor - Multicolor slats

**+ 5 %**

**+ 5 %**

mc 0,30 - Kg 34

mc 0,30 - Kg 34

#### PENSILI H. 70 WALL UNITS H. 70

1 ANTA LEGNO, 1 RIPIANO VETRO  
1 WOODEN DOOR, 1 GLASS SHELF

1 ANTA VETRO, 1 RIPIANO VETRO  
1 GLASS DOOR, 1 GLASS SHELF

2 ANTE LEGNO, 2 RIPIANI VETRO  
2 WOODEN DOORS, 2 GLASS SHELVES

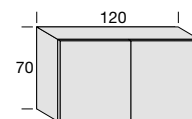
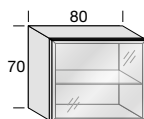
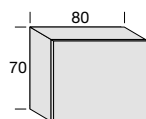

DX / RH  
SX / LH

**DOC2441K**  
**DOC2541K**

VETRO TRASPARENTE  
TRANSPARENT GLASS

**DOC2431K**  
**DOC2531K**

**OPTIONAL**

VETRO GLASS

TOP SOL

FUMÉ  
SMOKED

**DOC2611K**

CANALETTO

**981**

**1.250**

**+ 79**

**+ 37**

Doghe Multicolor - Multicolor slats

**+ 5 %**

**+ 5 %**

mc 0,25 - Kg 30

mc 0,25 - Kg 30

mc 0,38 - Kg 43

1 ANTA DOGATA, 1 RIPIANO VETRO  
1 SLATTED DOOR, 1 GLASS SHELF

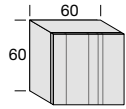

DOGA LEGNO LISCIA  
PLAIN WOODEN SLAT

DOC2216K DOC2316K	OPTIONAL			
	DOGA SLAT			
	DOGA RIGHE STRIPED SLAT	DOGA QUADRO LEGNO WOODEN SQUARE SLAT		
<b>1.215</b>	<b>+ 79</b>	<b>+ 110</b>		
<b>+ 5 %</b>				
mc 0,15 – Kg 20				

2 ANTE DOGATE, 2 RIPIANI VETRO  
2 SLATTED DOORS, 2 GLASS SHELVES

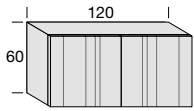

DOGA LEGNO LISCIA  
PLAIN WOODEN SLAT

DOC2236K	OPTIONAL			
	DOGA SLAT			
	DOGA RIGHE STRIPED SLAT	DOGA QUADRO LEGNO WOODEN SQUARE SLAT		
<b>2.146</b>	<b>+ 79</b>	<b>+ 110</b>		
<b>+ 5 %</b>				
mc 0,30 – Kg 34				

2 ANTE DOGATE, 2 RIPIANI VETRO  
2 SLATTED DOORS, 2 GLASS SHELVES

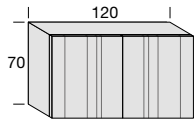

DOGA LEGNO LISCIA  
PLAIN WOODEN SLAT

DOC2616K	OPTIONAL			
	DOGA SLAT			
	DOGA RIGHE STRIPED SLAT	DOGA QUADRO LEGNO WOODEN SQUARE SLAT		
<b>1.888</b>	<b>+ 79</b>	<b>+ 110</b>		
<b>+ 5 %</b>				
mc 0,38 – Kg 43				

2 ANTE VETRO, 2 RIPIANI VETRO  
2 GLASS SHELVES 1 GLASS SHELF

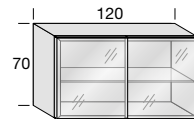

VETRO TRASPARENTE  
TRANSPARENT GLASS

DOC2601K	OPTIONAL			
	VETRO GLASS			
	TOP SOL	FUMÉ SMOKED		
<b>1.888</b>	<b>+ 158</b>	<b>+ 72</b>		
<b>+ 5 %</b>				
mc 0,38 – Kg 43				

OPTIONAL  
OPTIONAL

BARRA LED A BASSO CONSUMO  
ACCENSIONE TOUCH IN ALLUMINIO  
DA POSIZIONARE SUL COPERCHIO  
DEL PENSILE

LOW CONSUMPTION ALUMINIUM LED  
BAR WITH TOUCH SWITCH ON  
TO ARRANGE ON WALL UNIT TOP



ZZZFE22020

L. W. 40

**163**

ZZZFE22024

L. W. 60

**175**

ZZZFE22025

L. W. 80

**187**

ZZZFE22026

L. W. 120

**235**

ZZZFE22027

L. W. 140

**253**

ALIMENTATORE  
POWER SUPPLY



ZZZFE22002

**67**

COLLEGAMENTO  
A CARICO DEL CLIENTE  
CONNECTIONS  
TO BE MADE BY THE CUSTOMER.

# DOMINO SISTEMA COMPONIBILE - MODULAR SYSTEM

## PENSILI VERTICALI P. 38 VERTICAL WALL UNITS D. 38

### PENSILI H. 60 WALL UNITS H. 60

1 ANTA LEGNO, 1 RIPIANO VETRO  
1 WOODEN DOOR, 1 GLASS SHELF

1 ANTA VETRO, 1 RIPIANO VETRO  
1 GLASS DOOR, 1 GLASS SHELF

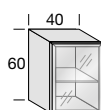
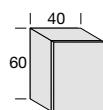

DX / RH  
SX / LH

**DOC2261K**  
**DOC2361K**

**DOC2251K**  
**DOC2351K**

**OPTIONAL**

VETRO GLASS

TOP SOL

FUMÉ  
SMOKED

CANALETTO

**752**

**896**

**+ 37**

**+ 19**

Doghe Multicolor - Multicolor slats

**+ 5 %**

**+ 5 %**

mc 0,10 - Kg 15

mc 0,10 - Kg 15

### PENSILI H. 70 WALL UNITS H. 70

1 ANTA LEGNO, 1 RIPIANO VETRO  
1 WOODEN DOOR, 1 GLASS SHELF

1 ANTA VETRO, 1 RIPIANO VETRO  
1 GLASS DOOR, 1 GLASS SHELF

1 ANTA LEGNO, 1 RIPIANO VETRO  
1 WOODEN DOOR, 1 GLASS SHELF

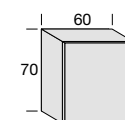
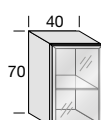
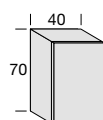

DX / RH  
SX / LH

**DOC2461K**  
**DOC2561K**

**DOC2451K**  
**DOC2551K**

**OPTIONAL**

VETRO GLASS

TOP SOL

FUMÉ  
SMOKED

CANALETTO

**794**

**938**

**+ 43**

**+ 19**

Doghe Multicolor - Multicolor slats

**+ 5 %**

**+ 5 %**

mc 0,12 - Kg 17

mc 0,12 - Kg 17

mc 0,19 - Kg 22

### PENSILI H. 105 WALL UNITS H. 105

1 ANTA LEGNO, 2 RIPIANI VETRO  
1 WOODEN DOOR, 2 GLASS DOORS

1 ANTA VETRO, 2 RIPIANI VETRO  
1 GLASS DOOR, 1 GLASS SHELF

2 ANTE LEGNO, 4 RIPIANI VETRO  
2 DOORS, 4 GLASS SHELVES

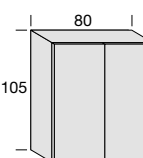
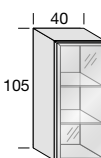
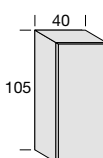

DX / RH  
SX / LH

**DOC2281K**  
**DOC2381K**

**DOC2271K**  
**DOC2371K**

**OPTIONAL**

VETRO GLASS

TOP SOL

FUMÉ  
SMOKED

CANALETTO

**1.047**

**1.125**

**+ 67**

**+ 24**

Doghe Multicolor - Multicolor slats

**+ 5 %**

**+ 5 %**

mc 0,18 - Kg 23

mc 0,18 - Kg 23

mc 0,35 - Kg 32

2 ANTE VETRO, 4 RIPIANI VETRO  
2 GLASS DOORS, 4 GLASS SHELVES

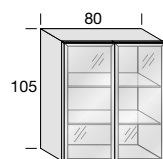

VETRO TRASPARENTE  
TRANSPARENT GLASS

**DOC2621K**

**OPTIONAL**

VETRO GLASS

TOP SOL

FUMÉ  
SMOKED

CANALETTO

**2.116**

**+ 133**

**+ 49**

Doghe Multicolor - Multicolor slats

**+ 5 %**

mc 0,18 - Kg 23

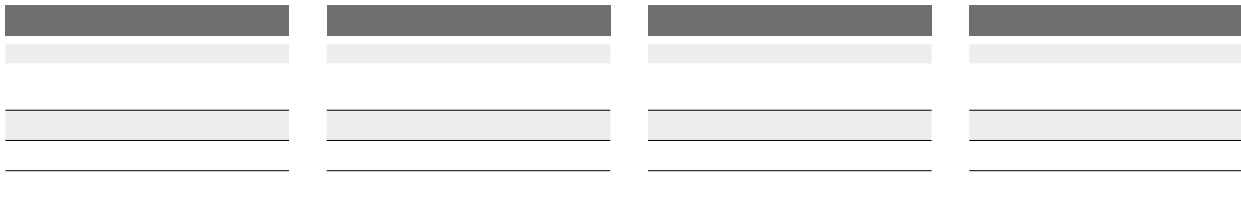

1 ANTA DOGATA, 1 RIPIANO VETRO  
1 SLATTED DOOR, 1 GLASS SHELF

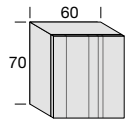

DOGA LEGNO LISCIA  
PLAIN WOODEN SLAT

DOC2406K DOC2506K	OPTIONAL	
	DOGA SLAT	
	DOGA RIGHE STRIPED SLAT	DOGA QUADRO LEGNO WOODEN SQUARE SLAT
<b>1.293</b>		
<b>+ 5 %</b>	<b>+ 79</b>	<b>+ 110</b>
mc 0,19 – Kg 22		

1 ANTA VETRO, 1 RIPIANO VETRO  
1 GLASS DOOR, 1 GLASS SHELF

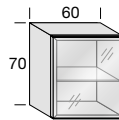

VETRO TRASPARENTE  
TRANSPARENT GLASS

DOC2291K DOC2391K	OPTIONAL	
	VETRO GLASS	
	TOP SOL	FUMÉ SMOKED
<b>1.047</b>		
<b>+ 5 %</b>	<b>+ 67</b>	<b>+ 24</b>
mc 0,19 – Kg 22		

1 ANTA LEGNO, 1 ANTA VETRO, 4 RIPIANI  
VETRO  
1 DOOR, 1 GLASS DOOR, 4 GLASS  
SHELVES

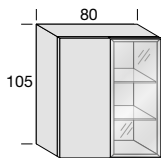

VETRO TRASPARENTE  
TRANSPARENT GLASS

DOC2991K	OPTIONAL	
	VETRO GLASS	
	TOP SOL	FUMÉ SMOKED
<b>1.973</b>		
<b>+ 5 %</b>	<b>+ 67</b>	<b>+ 24</b>
mc 0,35 – Kg 32		

1 ANTA LEGNO, 1 ANTA VETRO, 4 RIPIANI  
VETRO  
1 DOOR, 1 GLASS DOOR, 4 GLASS  
SHELVES

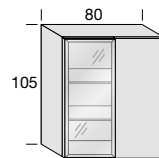

VETRO TRASPARENTE  
TRANSPARENT GLASS

DOC2491K	OPTIONAL	
	VETRO GLASS	
	TOP SOL	FUMÉ SMOKED
<b>1.973</b>		
<b>+ 5 %</b>	<b>+ 67</b>	<b>+ 24</b>
mc 0,35 – Kg 32		



OPTIONAL  
OPTIONAL

BARRA LED A BASSO CONSUMO  
ACCENSIONE TOUCH IN ALLUMINIO  
DA POSIZIONARE SUL COPERCHIO  
DEL PENSILE

LOW CONSUMPTION ALUMINIUM LED  
BAR WITH TOUCH SWITCH ON  
TO ARRANGE ON WALL UNIT TOP

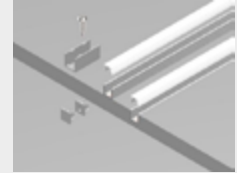

ZZZFE22020

L. W. 40

**163**

ZZZFE22024

L. W. 60

**175**

ZZZFE22025

L. W. 80

**187**

ZZZFE22026

L. W. 120

**235**

ZZZFE22027

L. W. 140

**253**

ALIMENTATORE  
POWER SUPPLY



ZZZFE22002

**67**

COLLEGAMENTO  
A CARICO DEL CLIENTE  
CONNECTIONS  
TO BE MADE BY THE CUSTOMER.

# DOMINO SISTEMA COMPONIBILE - MODULAR SYSTEM

## PENSILI VERTICALI P. 38, PENSILI A GIORNO E DIVISORI AD "U"

### VERTICAL WALL UNITS D. 38, OPEN WALL UNITS AND U-SHAPED PARTITIONS

#### PENSILI H. 120 WALL UNITS H. 120

2 ANTE LEGNO, 2 RIPIANI VETRO  
2 DOORS, 2 GLASS SHELVES

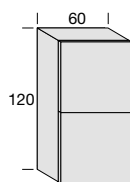

**DOC2671K**  
**DOC2681K**

**1.479**  
**+ 5 %**  
mc 0,30 – Kg 34

2 ANTE VETRO, 2 RIPIANI VETRO  
2 GLASS DOORS, 2 GLASS SHELVES

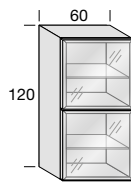

VETRO TRASPARENTE  
TRANSPARENT GLASS

**DOC2241K**  
**DOC2341K**

**1.773**  
**+ 5 %**  
mc 0,30 – Kg 34

#### OPTIONAL

VETRO GLASS

TOP SOL

**+ 102**

FUMÉ  
SMOKED

**+ 49**

CANALETTO

Doghe Multicolor - Multicolor slats

#### PENSILI H. 140 WALL UNITS H. 140

1 ANTA LEGNO, 3 RIPIANI VETRO  
1 WOODEN DOOR, 3 GLASS SHELVES

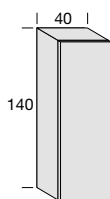

DX / RH  
SX / LH

**DOC2421K**  
**DOC2521K**

**1.191**  
**+ 5 %**  
mc 0,24 – Kg 28

1 ANTA VETRO, 3 RIPIANI VETRO  
1 GLASS DOOR, 3 GLASS SHELVES

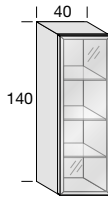

VETRO TRASPARENTE  
TRANSPARENT GLASS

**DOC2411K**  
**DOC2511K**

**1.275**  
**+ 5 %**  
mc 0,24 – Kg 28

#### OPTIONAL

VETRO GLASS

TOP SOL

**+ 85**

FUMÉ  
SMOKED

**+ 37**

2 ANTE LEGNO, 6 RIPIANI VETRO  
2 WOODEN DOORS, 6 GLASS SHELVES

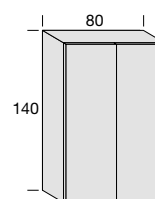

**DOC2811K**

**2.020**  
**+ 5 %**  
mc 0,47 – Kg 40

2 ANTE VETRO, 6 RIPIANI VETRO  
2 GLASS DOORS, 6 GLASS SHELVES

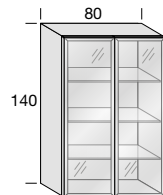

VETRO TRASPARENTE  
TRANSPARENT GLASS

**DOC2861K**

#### OPTIONAL

VETRO GLASS

TOP SOL

**+ 168**

FUMÉ  
SMOKED

**+ 72**

CANALETTO

Doghe Multicolor - Multicolor slats

#### PENSILI A GIORNO P. 38 OPEN WALL UNITS P. 38

A GIORNO  
OPEN



**DOC2701K**

**301**  
mc 0,03 – Kg 5

A GIORNO  
OPEN

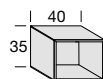

**DOC2711K**

**427**  
mc 0,06 – Kg 7

A GIORNO  
OPEN

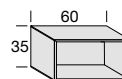

**DOC2721K**

**487**  
mc 0,12 – Kg 11

A GIORNO, 1 RIPIANO FISSO LEGNO  
OPEN, 1 WOODEN FIXED SHELF

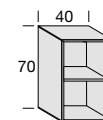

**DOC2731K**

**567**  
mc 0,18 – Kg 15

2 ANTE DOGATE, 2 RIPIANI VETRO  
2 SLATTED DOORS, 2 GLASS SHELVES

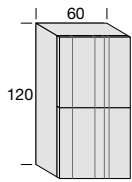

DOGA LEGNO LISCIA  
PLAIN WOODEN SLAT

<b>DOC2676K</b>	<b>OPTIONAL</b>			
<b>DOC2686K</b>	DOGA SLAT			
	DOGA RIGHE STRIPED SLAT	DOGA QUADRO LEGNO WOODEN SQUARE SLAT		
<b>2.146</b>	<b>+ 158</b>	<b>+ 217</b>		
<b>+ 5 %</b>				
mc 0,30 – Kg 34				

1 ANTA LEGNO, 1 ANTA VETRO, 6 RIPIANI VETRO  
1 DOOR, 1 GLASS DOOR, 6 GLASS SHELVES

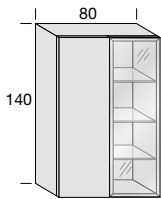

VETRO TRASPARENTE  
TRANSPARENT GLASS

<b>DOC2821K</b>	<b>OPTIONAL</b>			
	VETRO GLASS			
	TOP SOL	FUMÉ SMOKED		
<b>2.140</b>	<b>+ 85</b>	<b>+ 37</b>		
<b>+ 5 %</b>				
mc 0,47 – Kg 40				

1 ANTA LEGNO, 1 ANTA VETRO, 6 RIPIANI VETRO  
1 DOOR, 1 GLASS DOOR, 6 GLASS SHELVES

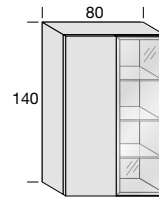

VETRO TRASPARENTE  
TRANSPARENT GLASS

<b>DOC2851K</b>	<b>OPTIONAL</b>			
	VETRO GLASS			
	TOP SOL	FUMÉ SMOKED		
<b>2.140</b>	<b>+ 85</b>	<b>+ 37</b>		
<b>+ 5 %</b>				
mc 0,47 – Kg 40				

**OPTIONAL**  
**OPTIONAL**

BARRA LED A BASSO CONSUMO  
ACCENSIONE TOUCH IN ALLUMINIO  
DA POSIZIONARE SUL COPERCHIO  
DEL PENSILE

LOW CONSUMPTION ALUMINIUM LED  
BAR WITH TOUCH SWITCH ON  
TO ARRANGE ON WALL UNIT TOP



**ZZZFE22020**

L. W. 40

**163**

**ZZZFE22024**

L. W. 60

**175**

**ZZZFE22025**

L. W. 80

**187**

**ZZZFE22026**

L. W. 120

**235**

**ZZZFE22027**

L. W. 140

**253**

ALIMENTATORE  
POWER SUPPLY



**ZZZFE22002**

**67**

COLLEGAMENTO  
A CARICO DEL CLIENTE  
CONNECTIONS  
TO BE MADE BY THE CUSTOMER.

A GIORNO, 2 RIPIANI FISSI LEGNO  
OPEN, 2 WOODEN FIXED SHELVES

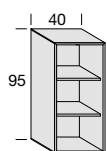

<b>DOC2742K</b>	<b>DOC2741K</b>		
<b>650</b>	<b>662</b>		
mc 0,18 – Kg 15	mc 0,19 – Kg 19		

A GIORNO, 2 RIPIANI FISSI LEGNO  
OPEN, 2 WOODEN FIXED SHELVES

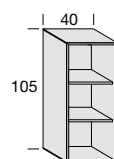

# DOMINO SISTEMA COMPONIBILE - MODULAR SYSTEM

## COLONNE A GIORNO P. 30

### RAISED TALL UNITS P. 30

#### DIVISORI AD "U" P. 30 (MENSOLA OBBLIGATORIA) U-SHAPED PARTITIONS D. 30 (COMPULSORY SHELF)

SENZA CAPPELLO, CON CORNICE  
WITHOUT TOP, WITH FRAME

SENZA CAPPELLO, CON CORNICE  
WITHOUT TOP, WITH FRAME

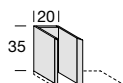
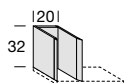

**DOC3981K**

**DOC3991K**

CANALETTO

**211**

mc 0,02 – Kg 0,5

**217**

mc 0,02 – Kg 0,5

#### COLONNE A GIORNO P. 30 DA APPOGGIO SOTTOPENSILI RAISED TALL UNITS P. 30 UNDER WALL UNITS

2 RIPIANI LEGNO  
2 WOODEN SHELVES

2 RIPIANI LEGNO  
2 WOODEN SHELVES

3 RIPIANI LEGNO  
3 WOODEN SHELVES

3 RIPIANI LEGNO  
3 WOODEN SHELVES

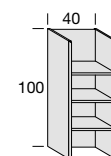
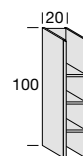
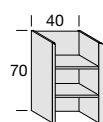
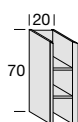

**DOC2801K**

**DOC2881K**

**DOC2651K**

**DOC2841K**

CANALETTO

**535**

mc 0,05 – Kg 6

**607**

mc 0,09 – Kg 7

**674**

mc 0,08 – Kg 9

**800**

mc 0,15 – Kg 11

#### COLONNE A GIORNO P. 30 DA APPOGGIO RAISED OPEN TALL UNITS P. 30

2 RIPIANI LEGNO  
2 WOODEN SHELVES

2 RIPIANI LEGNO  
2 WOODEN SHELVES

3 RIPIANI LEGNO  
3 WOODEN SHELVES

3 RIPIANI LEGNO  
3 WOODEN SHELVES

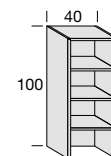
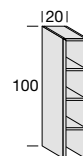
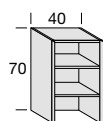
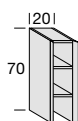

**DOC2911K**

**DOC2921K**

**DOC2661K**

**DOC2931K**

CANALETTO

**595**

mc 0,05 – Kg 7

**698**

mc 0,09 – Kg 8

**727**

mc 0,08 – Kg 10

**884**

mc 0,15 – Kg 12

#### MENSOLE DI GIUNZIONE P. 30 PER COLONNE A GIORNO IN APPOGGIO JOINT SHELVES D. 30 FOR RAISED OPEN TALL UNITS

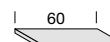

**DOC2801C**

**DOC2811C**

**DOC2821C**

CANALETTO

**67**

mc 0,01 – Kg 0,5

**91**

mc 0,01 – Kg 1

**115**

mc 0,01 – Kg 1,5



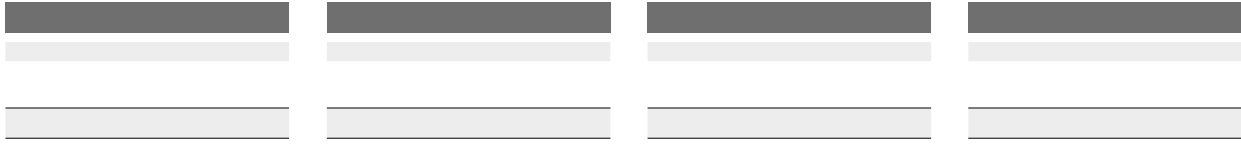

**2 RIPIANI LEGNO**  
2 WOODEN SHELVES

**2 RIPIANI LEGNO**  
2 WOODEN SHELVES

**3 RIPIANI LEGNO**  
3 WOODEN SHELVES

**3 RIPIANI LEGNO**  
3 WOODEN SHELVES

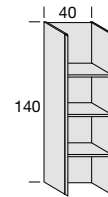
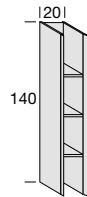
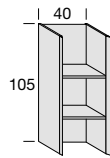
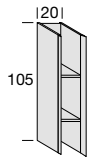

**DOC2631K**

**DOC2871K**

**DOC2891K**

**DOC2901K**

**638**

mc 0,07 – Kg 9

**813**

mc 0,14 – Kg 11

**770**

mc 0,09 – Kg 13

**890**

mc 0,18 – Kg 16

**2 RIPIANI LEGNO**  
2 WOODEN SHELVES

**2 RIPIANI LEGNO**  
2 WOODEN SHELVES

**3 RIPIANI LEGNO**  
3 WOODEN SHELVES

**3 RIPIANI LEGNO**  
3 WOODEN SHELVES

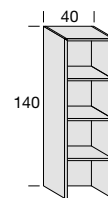
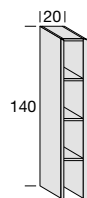
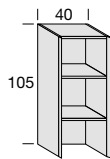
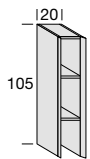

**DOC2641K**

**DOC2941K**

**DOC2951K**

**DOC2961K**

**698**

mc 0,07 – Kg 9

**896**

mc 0,14 – Kg 11

**831**

mc 0,09 – Kg 14

**975**

mc 0,18 – Kg 17



# DOMINO SISTEMA COMPONIBILE - MODULAR SYSTEM

## COMPOSIZIONI A CATALOGO

## CATALOGUE COMPOSITIONS

### COMPOSIZIONE 17

### COMPOSITION 17

PAG. 74-75 CATALOGO "DESIGN"  
PAGE 74-75 "DESIGN" CATALOGUE

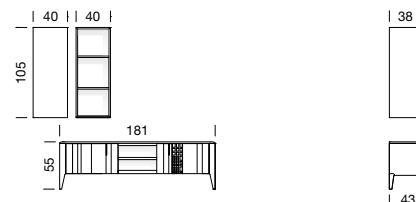

1	<b>DOC2381K</b>	PENSILE VERTICALE ANTA LEGNO SX L 40 H 105 VERTICAL WALL UNIT WITH WOODEN DOOR LH W 40 H 105	<b>1.047</b>
1	<b>DOC2741K</b>	PENSILE A GIORNO L 40 H 105 OPEN WALL UNIT W 40 H 105	<b>662</b>
1	<b>DOG5006K</b>	PORTA TV L 181 H 55 P 43 DOGA LEGNO QUADRO TV UNIT W 181 H 55 D 43 SQUARE WOODEN SLAT	<b>3.386</b>
<b>PREZZO TOT. COMPOSIZIONE</b> TOTAL PRICE FOR COMPOSITION			<b>5.095</b>



L. W. 181  
P. D. 38/43

### COMPOSIZIONE 40

### COMPOSITION 40

PAG. 110-111 CATALOGO "DESIGN"  
PAGE 110-111 "DESIGN" CATALOGUE

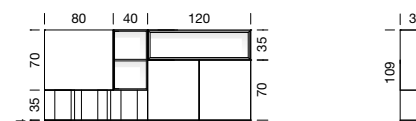
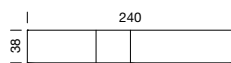

1	<b>DOC2541K</b>	PENSILE ANTA LEGNO SX L 80 H 70 WALL UNIT WITH WOODEN DOOR LH W 80 H 70	<b>981</b>
1	<b>DOC2611K</b>	PENSILE 2 ANTE LEGNO L 120 H 70 WALL UNIT WITH 2 WOODEN DOORS W 120 H 70	<b>1.569</b>
1	<b>DOC2731K</b>	PENSILE A GIORNO L 40 H 70 OPEN WALL UNIT W 40 H 70	<b>567</b>
1	<b>DOC2781K</b>	PENSILE A GIORNO CON CORNICE L 120 H 35 OPEN WALL UNIT WITH FRAME W 120 H 35	<b>836</b>
1	<b>DOC1376K</b>	BASE CESTONE L 120 P 38 DOGA LEGNO LISCIA BASE UNIT WITH BASKET W 120 D 38 PLAIN WOODEN SLAT	<b>1.341</b>
1	<b>DOC3321K</b>	ZOCCOLO L 240 P 35 PLINTH W 240 D 35	<b>349</b>
<b>PREZZO TOT. COMPOSIZIONE</b> TOTAL PRICE FOR COMPOSITION			<b>5.643</b>



L. W. 240  
P. D. 38

### COMPOSIZIONE 86

### COMPOSITION 86

PAG. 122-123 CATALOGO "DESIGN"  
PAGE 122-123 "DESIGN" CATALOGUE

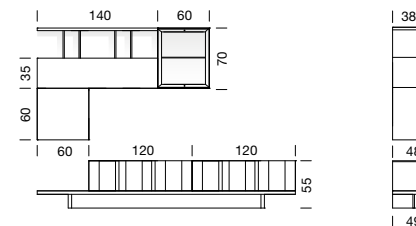
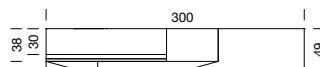

1	<b>DOC3051K</b>	PEDANA L 300 P 49 PLATFORM W 300 D 49	<b>999</b>
2	<b>DOC1066K</b>	BASE CESTONE L 120 P 48 DOGA LEGNO LISCIA BASE UNIT WITH BASKET W 120 D 48 PLAIN WOODEN SLAT	<b>2.706</b>
1	<b>DOC5101K</b>	TOP L 240 P 45 TOP W 240 D 45	<b>349</b>
1	<b>DOC3551K</b>	MENSOLA L 140 P 30 SHELF W 140 D 30	<b>247</b>
2	<b>DOC3981K</b>	DIVISORIO AD U L 20 H 32 U-SHAPED PARTITION W 20 H 35	<b>422</b>
1	<b>DOC2291K</b>	PENSILE ANTA VETRO TOP SOL DX L 60 H 70 WALL UNIT WITH TOP SOL GLASS DOOR RH W 60 H 70	<b>1.114</b>
1	<b>DOC2191K</b>	PENSILE VASISTAS ANTA LEGNO 140 WALL UNIT WITH WOODEN LIFT-UP DOOR W 140	<b>1.119</b>
1	<b>DOC2311K</b>	PENSILE ANTA LEGNO SX L 60 H 60 WALL UNIT WITH WOODEN DOOR RH W 60 H 60	<b>848</b>
<b>TOTALE COMPOSIZIONE</b> TOTAL PRICE FOR COMPOSITION			<b>7.804</b>

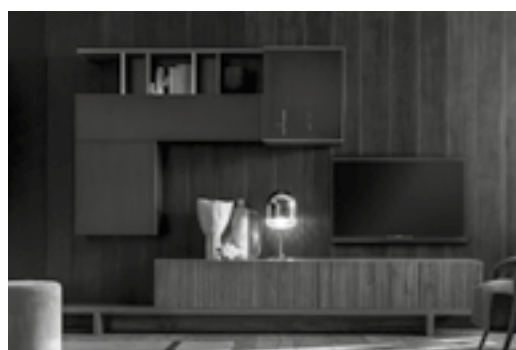

L. W. 300  
P. D. 49

## COMPOSIZIONI A CATALOGO CATALOGUE COMPOSITIONS

### COMPOSIZIONE 87/B

#### COMPOSITION 87/B

PAG. 124-125 CATALOGO "DESIGN"  
PAGE 124-125 "DESIGN" CATALOGUE

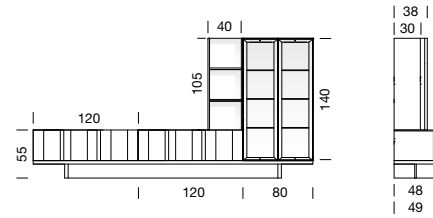
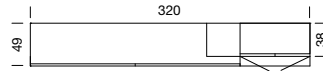

1	<b>DOC3061K</b>	PEDANA L 320 P 49 PLATFORM W 320 D 49	<b>1.023</b>
2	<b>DOC1066K</b>	BASE CESTONE L 120 P 48 DOGA LEGNO LISCIA BASE UNIT WITH BASKET W 120 D 48 PLAIN WOODEN SLAT	<b>2.706</b>
1	<b>DOC5101K</b>	TOP L 240 P 45 TOP W 240 D 45	<b>349</b>
1	<b>DOC2861K</b>	PENSILE 2 ANTE VETRO FUMÉ L 80 H 140 WALL UNIT WITH 2 SMOKED GLASS DOORS W 80 H 140	<b>2.386</b>
1	<b>DOC2941K</b>	COLONNA A GIORNO SOTTOPENSILE 2 RIPIANI L 40 H 105 OPEN TALL UNIT UNDER WALL UNIT WITH 2 SHELVES W 40 H 105	<b>896</b>
<b>TOTALE COMPOSIZIONE</b> TOTAL PRICE FOR COMPOSITION			<b>7.360</b>



L. W. 320  
P. D. 49

### COMPOSIZIONE 90/A

#### COMPOSITION 907A

PAG. 128-129 CATALOGO "DESIGN"  
PAGE 128-129 "DESIGN" CATALOGUE

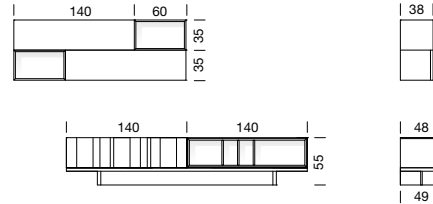
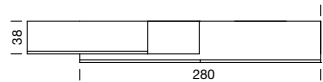

1	<b>DOC3041K</b>	PEDANA L 280 P 49 PLATFORM W 280 D 49	<b>938</b>
1	<b>DOC1086K</b>	BASE CESTONE L 140 P 48 DOGA LEGNO LISCIA BASE UNIT WITH BASKET W 140 D 48 PLAIN WOODEN SLAT	<b>1.432</b>
1	<b>DOC1621K</b>	BASE A GIORNO CON 3 DIVISORI INTERNI L 140 P 48 OPEN BASE UNIT WITH 3 INTERNAL PARTITIONS W 140 P 48	<b>1.155</b>
1	<b>DOC5121K</b>	TOP L 280 P 45 TOP W 280 D 45	<b>397</b>
2	<b>DOC2721K</b>	PENSILE A GIORNO L 60 H 35 OPEN WALL UNIT W 60 H 35	<b>974</b>
1	<b>DOC2191K</b>	PENSILE VASISTAS ANTA LEGNO L 140 WALL UNIT WITH WOODEN LIFT-UP DOOR W 140	<b>1.119</b>
1	<b>DOC2171K</b>	PENSILE RIBALTA ANTA LEGNO L 140 WALL UNIT WITH WOODEN DROP-DOWN DOOR W 140	<b>1.197</b>
<b>TOTALE COMPOSIZIONE</b> TOTAL PRICE FOR COMPOSITION			<b>7.212</b>



L. W. 340  
P. D. 49

### COMPOSIZIONE 84

#### COMPOSITION 84

PAG. 130-131 CATALOGO "DESIGN"  
PAGE 130-131 "DESIGN" CATALOGUE

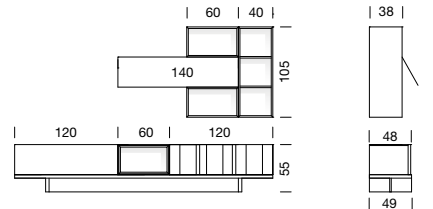
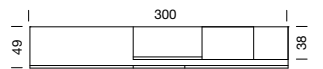

1	<b>DOC3051K</b>	PEDANA L 300 P 49 PLATFORM W 300 D 49	<b>999</b>
1	<b>DOC1221K</b>	BASE A GIORNO L 60 P 48 OPEN BASE UNIT W 60 D 48	<b>650</b>
1	<b>DOC1066K</b>	BASE CESTONE L 120 P 48 DOGA LEGNO LISCIA BASE UNIT WITH BASKET W 120 D 48 PLAIN WOODEN SLAT	<b>1.353</b>
1	<b>DOC1061K</b>	BASE CESTONE L 120 P 48 BASE UNIT WITH BASKET W 120 D 48 PLAIN	<b>1.059</b>
1	<b>DOC5131K</b>	TOP L 300 P 45 TOP W 300 D 45	<b>422</b>
1	<b>DOC2741K</b>	PENSILE A GIORNO L 40 H 105 OPEN WALL UNIT W 40 H 105	<b>662</b>
2	<b>DOC2721K</b>	PENSILE A GIORNO L 60 H 35 OPEN WALL UNIT W 60 H 35	<b>974</b>
1	<b>DOC2191K</b>	PENSILE VASISTAS ANTA LEGNO L 140 WALL UNIT WITH WOODEN LIFT-UP DOOR W 140	<b>1.119</b>
<b>TOTALE COMPOSIZIONE</b> TOTAL PRICE FOR COMPOSITION			<b>7.238</b>



L. W. 300  
P. D. 49

# DOMINO SISTEMA COMPONIBILE - MODULAR SYSTEM

## COMPOSIZIONI A CATALOGO

### CATALOGUE COMPOSITIONS

#### COMPOSIZIONE 50

#### COMPOSITION 50

PAG. 132-133 CATALOGO "DESIGN"  
PAGE 132-133 "DESIGN" CATALOGUE

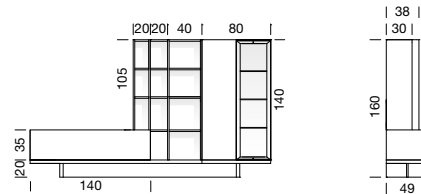
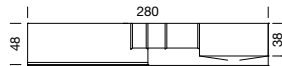

1	<b>DOC2641K</b>	COLONNA A GIORNO 2 RIPIANI L 20 H 105 OPEN TALL UNIT WITH 2 SHELVES W 20 H 105	<b>698</b>
4	<b>DOC2801C</b>	MENSOLE DI GIUNZIONE L 20 JOINT SHELVES W 20	<b>268</b>
1	<b>DOC2961K</b>	COLONNA A GIORNO 3 RIPIANI L 40 H 140 OPEN TALL UNIT WITH 3 SHELVES W 40 H 140	<b>975</b>
1	<b>DOC2821K</b>	PENSILE VERTICALE ANTA LEGNO SX ANTA VETRO TRASPARENTE DX L 80 H 140 VERTICAL WALL UNIT WITH PLAIN WOODEN DOOR LH TRANSPARENT GLASS DOOR RH W 80 H 140	<b>2.140</b>
1	<b>DOC1081K</b>	BASE CESTONE L 140 P 48 BASE UNIT WITH BASKET W 140 D 48 PLAIN	<b>1.167</b>
1	<b>DOC5051K</b>	TOP L 140 P 45 TOP W 140 D 45	<b>206</b>
1	<b>DOC3041K</b>	PEDANA L 280 P 49 PLATFORM W 280 D 49	<b>938</b>
<b>PREZZO TOT. COMPOSIZIONE</b> TOTAL PRICE FOR COMPOSITION			<b>6.392</b>



L. W. 280  
P. D. 38/49

#### COMPOSIZIONE 06

#### COMPOSITION 06

PAG. 134-135 CATALOGO "DESIGN"  
PAGE 134-135 "DESIGN" CATALOGUE

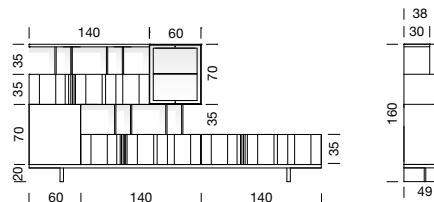
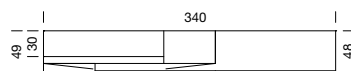

1	<b>DOC3551K</b>	MENSOLA L 140 SHELF W 140	<b>247</b>
2	<b>DOC3981K</b>	DIVISORIO AD U L 20 H 32 U-SHAPED PARTITION W 20 H 32	<b>422</b>
1	<b>DOC2291K</b>	PENSILE VERTICALE ANTA VETRO TOP SOL DX L 60 H 70 VERTICAL WALL UNIT WITH TOP SOL GLASS DOOR RH W 60 H 70	<b>1.112</b>
1	<b>DOC2176K</b>	PENSILE RIBALTA L 140 P 38 DOGA RIGHE WALL UNIT DROP-DOWN DOOR W 140 D 38 RIBBED SLAT	<b>1.630</b>
2	<b>DOC3991K</b>	DIVISORIO AD U L 20 H 35 U-SHAPED PARTITION W 20 H 35	<b>434</b>
1	<b>DOC2501K</b>	PENSILE VERTICALE ANTA LEGNO SX L 60 H 70 VERTICAL WALL UNIT WITH WOODEN DOOR LH W 60 H 70	<b>871</b>
2	<b>DOC1086K</b>	BASE CESTONE L 140 P 48 DOGA RIGHE BASE UNIT WITH BASKET W 140 D 48 RIBBED SLAT	<b>2.998</b>
1	<b>DOC5121K</b>	TOP L 280 P 45 TOP W 280 D 45	<b>397</b>
1	<b>DOC3071K</b>	PEDANA L 340 P 49 PLATFORM W 340 D 49	<b>1.047</b>
<b>PREZZO TOT. COMPOSIZIONE</b> TOTAL PRICE FOR COMPOSITION			<b>9.158</b>



L. W. 340  
P. D. 38/49

#### COMPOSIZIONE 160

#### COMPOSITION 160

PAG. 138-139 CATALOGO "DESIGN"  
PAGE 138-139 "DESIGN" CATALOGUE

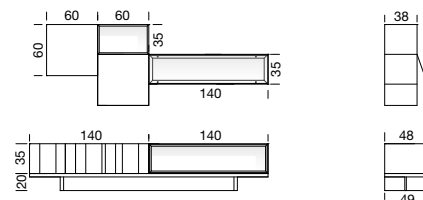
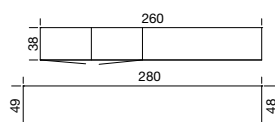

1	<b>DOC2311K</b>	PENSILE VERTICALE ANTA LEGNO SX L 60 H 60 VERTICAL WALL UNIT WITH WOODEN DOOR LH W 60 H 60	<b>848</b>
1	<b>DOC2211K</b>	PENSILE VERTICALE ANTA LEGNO DX L 60 H 60 VERTICAL WALL UNIT WITH WOODEN DOOR RH W 60 H 60	<b>848</b>
1	<b>DOC2721K</b>	PENSILE A GIORNO L 60 H 35 OPEN WALL UNIT W 60 H 35	<b>487</b>
1	<b>DOC2181K</b>	PENSILE VASISTAS ANTA VETRO TOP SOL L 140 P 38 WALL UNIT WITH TOP SOL GLASS LIFT-UP DOOR W 140 D 38	<b>1.408</b>
1	<b>DOC1086K</b>	BASE CESTONE L 140 P 48 DOGA LEGNO LISCIA BASE UNIT WITH BASKET W 140 D 48 PLAIN WOODEN SLAT	<b>1.432</b>
1	<b>DOC1251K</b>	BASE A GIORNO L 140 P 48 OPEN BASE UNIT W 140 D 48	<b>938</b>
1	<b>DOC5121K</b>	TOP L 280 P 45 TOP W 280 D 45	<b>397</b>
1	<b>DOC3041K</b>	PEDANA L 280 P 49 PLATFORM W 280 D 49	<b>938</b>
<b>PREZZO TOT. COMPOSIZIONE</b> TOTAL PRICE FOR COMPOSITION			<b>7.296</b>

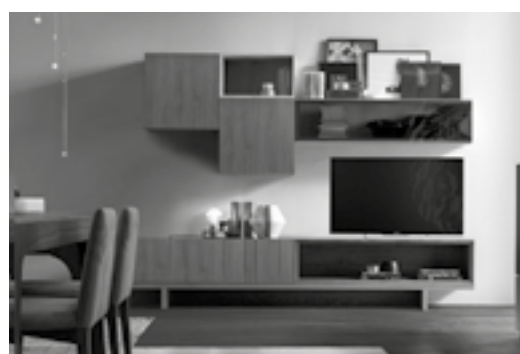

L. W. 280  
P. D. 38/49

## COMPOSIZIONI A CATALOGO CATALOGUE COMPOSITIONS

### COMPOSIZIONE 04 COMPOSITION 04

PAG. 142-143 CATALOGO "DESIGN"  
PAGE 142-143 "DESIGN" CATALOGUE

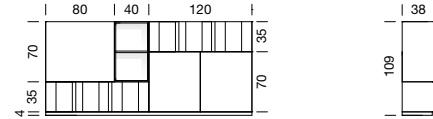
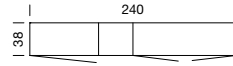

1	<b>DOC2541K</b>	PENSILE ANTA LEGNO SX L 80 H 70 WALL UNIT WITH WOODEN DOOR LH W 80 H 70	<b>981</b>
1	<b>DOC2611K</b>	PENSILE 2 ANTE LEGNO L 120 H 70 WALL UNIT WITH 2 WOODEN DOORS W 120 H 70	<b>1.569</b>
1	<b>DOC2731K</b>	PENSILE A GIORNO L 40 H 70 OPEN WALL UNIT W 40 H 70	<b>567</b>
1	<b>DOC2136K</b>	PENSILE RIBALTA L 120 P 38 DOGA LEGNO LISCIA WALL UNIT DROP-DOWN W 120 D 38 PLAIN WOODEN SLAT	<b>1.419</b>
1	<b>DOC1376K</b>	BASE CESTONE L 120 P 38 DOGA LEGNO LISCIA BASE UNIT WITH BASKET W 120 D 38 PLAIN WOODEN SLAT	<b>1.341</b>
1	<b>DOC3321K</b>	ZOCOLO L 240 P 35 PLINTH W 240 D 35	<b>349</b>
<b>PREZZO TOT. COMPOSIZIONE</b> TOTAL PRICE FOR COMPOSITION			<b>6.226</b>



L. W. 240  
P. D. 38

### COMPOSIZIONE 20 COMPOSITION 20

PAG. 8 CATALOGO "PROPOSTE ARREDATIVE"  
PAGE 8 "FURNISHING PROPOSALS" CATALOGUE

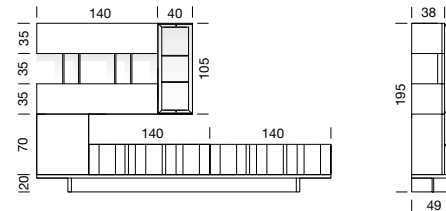
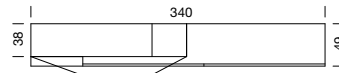

1	<b>DOC3071K</b>	PEDANA L 340 P 49 PLATFORM W 340 D 49	<b>1.047</b>
2	<b>DOC1086K</b>	BASE CESTONE L 140 P 48 DOGA LEGNO LISCIA BASE UNIT WITH BASKET W 140 D 48 PLAIN WOODEN SLAT	<b>2.864</b>
1	<b>DOC5121K</b>	TOP L 280 P 45 TOP W 280 D 45	<b>397</b>
1	<b>DOC2501K</b>	PENSILE VERTICALE ANTA LEGNO SX L 60 H 70 VERTICAL WALL UNIT WITH WOODEN DOOR LH W 60 H 70	<b>871</b>
1	<b>DOC2171K</b>	PENSILE RIBALTA ANTA LEGNO L 140 WALL UNIT WITH WOODEN DROP-DOWN DOOR W 140	<b>1.197</b>
1	<b>DOC2271K</b>	PENSILE VERTICALE ANTA VETRO DX L 40 H 105 VERTICAL WALL UNIT WITH GLASS DOOR RH W 40 H 105	<b>1.125</b>
2	<b>DOC3991K</b>	DIVISORIO AD U L 20 H 35 U-SHAPED PARTITION W 20 H 35	<b>434</b>
1	<b>DOC2191K</b>	PENSILE VASISTAS ANTA LEGNO L 140 WALL UNIT WITH WOODEN LIFT-UP DOOR W 140	<b>1.119</b>
<b>PREZZO TOT. COMPOSIZIONE</b> TOTAL PRICE FOR COMPOSITION			<b>9.054</b>



L. W. 340  
P. D. 38/49

### COMPOSIZIONE 22 COMPOSITION 22

PAG. 9 CATALOGO "PROPOSTE ARREDATIVE"  
PAGE 9 "FURNISHING PROPOSALS" CATALOGUE

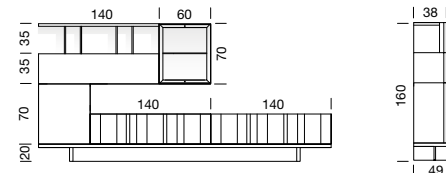
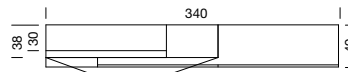

1	<b>DOC3071K</b>	PEDANA L 340 P 49 PLATFORM W 340 D 49	<b>1.047</b>
2	<b>DOC1086K</b>	BASE CESTONE L 140 P 48 DOGA LEGNO LISCIA BASE UNIT WITH BASKET W 140 D 48 PLAIN WOODEN SLAT	<b>2.864</b>
1	<b>DOC5121K</b>	TOP L 280 P 45 TOP W 280 D 45	<b>397</b>
1	<b>DOC2501K</b>	PENSILE VERTICALE ANTA LEGNO SX L 60 H 70 VERTICAL WALL UNIT WITH WOODEN DOOR LH W 60 H 70	<b>871</b>
1	<b>DOC2171K</b>	PENSILE RIBALTA ANTA LEGNO L 140 WALL UNIT WITH WOODEN DROP-DOWN DOOR W 140	<b>1.197</b>
1	<b>DOC2291K</b>	PENSILE VERTICALE ANTA VETRO DX L 60 H 70 VERTICAL WALL UNIT WITH GLASS DOOR RH W 60 H 70	<b>1.047</b>
2	<b>DOC3981K</b>	DIVISORIO AD U L 20 H 32 U-SHAPED PARTITION W 20 H 32	<b>422</b>
1	<b>DOC3551K</b>	MENSOLA L 140 SHELF W 140	<b>247</b>
<b>PREZZO TOT. COMPOSIZIONE</b> TOTAL PRICE FOR COMPOSITION			<b>8.092</b>



L. W. 340  
P. D. 38/49

# DOMINO SISTEMA COMPONIBILE - MODULAR SYSTEM

## COMPOSIZIONI A CATALOGO

## CATALOGUE COMPOSITIONS

### COMPOSIZIONE 24

#### COMPOSITION 24

PAG. 10 CATALOGO "PROPOSTE ARREDATIVE"  
PAGE 10 "FURNISHING PROPOSALS" CATALOGUE

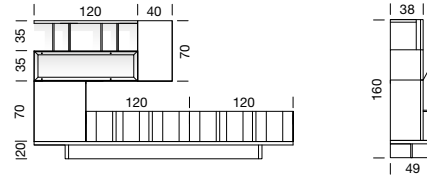
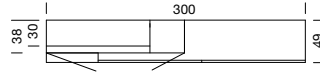

1	<b>DOC3051K</b>	PEDANA L 300 P 49 PLATFORM W 300 D 49	<b>999</b>
2	<b>DOC1066K</b>	BASE CESTONE L 120 P 48 DOGA LEGNO LISCIA BASE UNIT WITH BASKET W 120 D 48 PLAIN WOODEN SLAT	<b>2.706</b>
1	<b>DOC5101K</b>	TOP L 240 P 45 TOP W 240 D 45	<b>349</b>
1	<b>DOC2501K</b>	PENSILE VERTICALE ANTA LEGNO SX L 60 H 70 VERTICAL WALL UNIT WITH WOODEN DOOR LH W 60 H 70	<b>871</b>
1	<b>DOC2121K</b>	PENSILE RIBALTA ANTA VETRO L 120 WALL UNIT WITH GLASS DROP-DOWN DOOR W 120	<b>1.209</b>
1	<b>DOC2461K</b>	PENSILE VERTICALE ANTA LEGNO DX L 40 H 70 VERTICAL WALL UNIT WITH WOODEN DOOR RH W 40 H 70	<b>794</b>
2	<b>DOC3981K</b>	DIVISORIO AD U L 20 H 32 U-SHAPED PARTITION W 20 H 32	<b>422</b>
1	<b>DOC3541K</b>	MENSOLA L 120 SHELF W 120	<b>217</b>
<b>PREZZO TOT. COMPOSIZIONE</b> <b>TOTAL PRICE FOR COMPOSITION</b>			<b>7.567</b>



L. W. 300  
P. D. 38/49

### COMPOSIZIONE 26

#### COMPOSITION 26

PAG. 11 CATALOGO "PROPOSTE ARREDATIVE"  
PAGE 11 "FURNISHING PROPOSALS" CATALOGUE

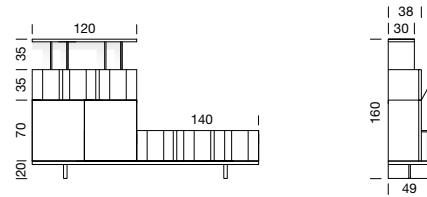
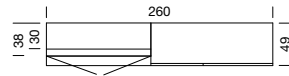

1	<b>DOC3031K</b>	PEDANA L 260 P 49 PLATFORM W 320 D 49	<b>848</b>
1	<b>DOC1086K</b>	BASE CESTONE L 140 P 48 DOGA LEGNO LISCIA BASE UNIT WITH BASKET W 140 D 48 PLAIN WOODEN SLAT	<b>1.432</b>
1	<b>DOC5051K</b>	TOP L 140 P 45 TOP W 140 D 45	<b>206</b>
1	<b>DOC2611K</b>	PENSILE ORIZZONTALE 2 ANTE LEGNO L 120 H 70 HORIZONTAL WALL UNIT WITH 2 WOODEN DOORS W 120 H 70	<b>1.569</b>
1	<b>DOC2136K</b>	PENSILE RIBALTA L 120 DOGA LEGNO LISCIA WALL UNIT DROP-DOWN W 120 PLAIN WOODEN SLAT	<b>1.419</b>
2	<b>DOC3981K</b>	DIVISORIO AD U L 20 H 32 U-SHAPED PARTITION W 20 H 32	<b>422</b>
1	<b>DOC3541K</b>	MENSOLA L 120 SHELF W 120	<b>217</b>
<b>PREZZO TOT. COMPOSIZIONE</b> <b>TOTAL PRICE FOR COMPOSITION</b>			<b>6.113</b>

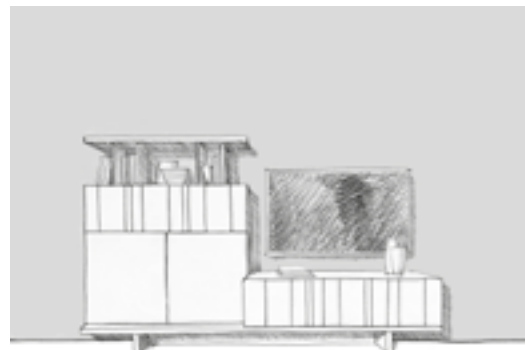

L. W. 260  
P. D. 38/49

### COMPOSIZIONE 28

#### COMPOSITION 28

PAG. 12 CATALOGO "PROPOSTE ARREDATIVE"  
PAGE 12 "FURNISHING PROPOSALS" CATALOGUE

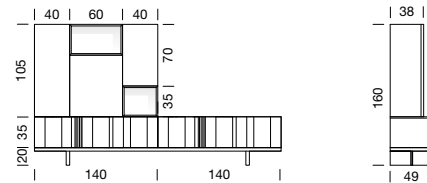
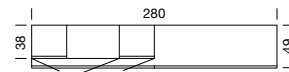

1	<b>DOC3041K</b>	PEDANA L 280 P 49 PLATFORM W 280 D 49	<b>938</b>
2	<b>DOC1086K</b>	BASE CESTONE L 140 P 48 DOGA RIGHE BASE UNIT WITH BASKET W 140 D 48 RIBBED SLAT	<b>2.998</b>
1	<b>DOC5121K</b>	TOP L 280 P 45 TOP W 280 D 45	<b>397</b>
1	<b>DOC2381K</b>	PENSILE VERTICALE ANTA LEGNO SX L 40 H 105 VERTICAL WALL UNIT WITH WOODEN DOOR LH W 40 H 105	<b>1.047</b>
1	<b>DOC2401K</b>	PENSILE VERTICALE ANTA LEGNO DX L 60 H 70 VERTICAL WALL UNIT WITH WOODEN DOOR RH W 60 H 70	<b>871</b>
1	<b>DOC2461K</b>	PENSILE VERTICALE ANTA LEGNO DX L 40 H 70 VERTICAL WALL UNIT WITH WOODEN DOOR RH W 40 H 70	<b>794</b>
1	<b>DOC2721K</b>	PENSILE A GIORNO L 60 H 35 OPEN WALL UNIT W 60 H 35	<b>487</b>
1	<b>DOC2711K</b>	PENSILE A GIORNO L 40 H 35 OPEN WALL UNIT W 40 H 35	<b>427</b>
<b>PREZZO TOT. COMPOSIZIONE</b> <b>TOTAL PRICE FOR COMPOSITION</b>			<b>7.959</b>

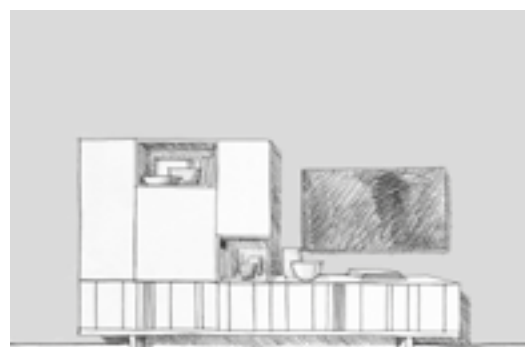

L. W. 280  
P. D. 38/49

## COMPOSIZIONI A CATALOGO CATALOGUE COMPOSITIONS

### COMPOSIZIONE 30 COMPOSITION 30

PAG. 13 CATALOGO "PROPOSTE ARREDATIVE"  
PAGE 13 "FURNISHING PROPOSALS" CATALOGUE

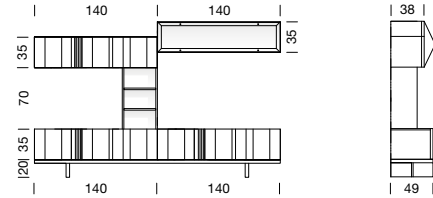
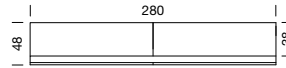

1	<b>DOC3041K</b>	PEDANA L 280 P 49 PLATFORM W 280 D 49	<b>938</b>
2	<b>DOC1086K</b>	BASE CESTONE L 140 P 48 DOGA RICHE BASE UNIT WITH BASKET W 140 D 48 RIBBED SLAT	<b>2.998</b>
1	<b>DOC5121K</b>	TOP L 280 P 45 TOP W 280 D 45	<b>397</b>
1	<b>DOC2881K</b>	COLONNA A GIORNO SOTTO PENSILE CON 2 RIPIANI LEGNO L 40 H 70 OPEN TALL UNIT UNDER WALL UNIT WITH 2 WOODEN SHELVES W 40 H 70	<b>607</b>
1	<b>DOC2176K</b>	PENSILE RIBALTA L 140 DOGA RICHE WALL UNIT DROP-DOWN W 140 RIBBED SLAT	<b>1.631</b>
1	<b>DOC2181K</b>	PENSILE VASISTAS ANTA VETRO L 140 WALL UNIT WITH GLASS LIFT-UP DOOR W 140	<b>1.323</b>
<b>PREZZO TOT. COMPOSIZIONE</b> TOTAL PRICE FOR COMPOSITION			<b>7.894</b>

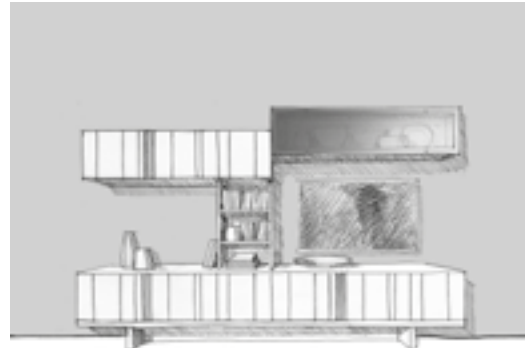

L. W. 280  
P. D. 38/49

### COMPOSIZIONE 32 COMPOSITION 32

PAG. 14 CATALOGO "PROPOSTE ARREDATIVE"  
PAGE 14 "FURNISHING PROPOSALS" CATALOGUE

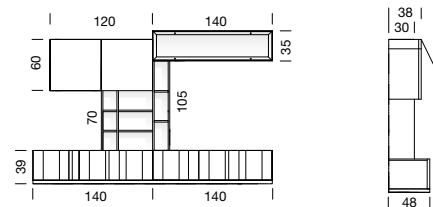
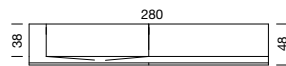

1	<b>DOC3191K</b>	ZOCOCCO L 280 P 45 PLINTH W 280 D 45	<b>409</b>
2	<b>DOC1086K</b>	BASE CESTONE L 140 P 48 DOGA LEGNO LISCIA BASE UNIT WITH BASKET W 140 D 48 PLAIN WOODEN SLAT	<b>2.864</b>
1	<b>DOC5121K</b>	TOP L 280 P 45 TOP W 280 D 45	<b>397</b>
1	<b>DOC2801K</b>	COLONNA A GIORNO SOTTOPENSILE L 20 H 70 CON 2 RIPIANI OPEN TALL UNIT UNDER WALL UNIT W 20 H 70 CON 2 SHELVES	<b>535</b>
2	<b>DOC2811C</b>	MENSOLA DI GIUNZIONE L 40 JOINT SHELF W 40	<b>182</b>
1	<b>DOC2631K</b>	COLONNA A GIORNO SOTTOPENSILE L 20 H 105 CON 2 RIPIANI OPEN TALL UNIT UNDER WALL UNIT W 20 H 105 WITH 2 SHELVES	<b>638</b>
1	<b>DOC2231K</b>	PENSILE ORIZZONTALE 2 ANTE LEGNO L 120 H 60 HORIZONTAL WALL UNIT WITH 2 WOODEN DOORS W 120 H 60 PLAIN	<b>1.479</b>
1	<b>DOC2181K</b>	PENSILE VASISTAS ANTA VETRO L 140 WALL UNIT WITH GLASS LIFT-UP DOOR W 140	<b>1.323</b>
<b>PREZZO TOT. COMPOSIZIONE</b> TOTAL PRICE FOR COMPOSITION			<b>7.827</b>



L. W. 280  
P. D. 38/48

### COMPOSIZIONE 34 COMPOSITION 34

PAG. 15 CATALOGO "PROPOSTE ARREDATIVE"  
PAGE 15 "FURNISHING PROPOSALS" CATALOGUE

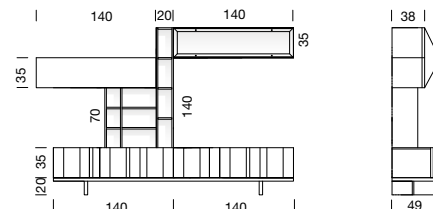
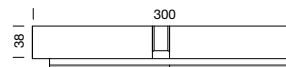

1	<b>DOC3041K</b>	PEDANA L 280 P 49 PLATFORM W 280 D 49	<b>938</b>
2	<b>DOC1086K</b>	BASE CESTONE L 140 P 48 DOGA LEGNO LISCIA BASE UNIT WITH BASKET W 140 D 48 PLAIN WOODEN SLAT	<b>2.864</b>
1	<b>DOC5121K</b>	TOP L 280 P 45 TOP W 280 D 45	<b>397</b>
1	<b>DOC2801K</b>	COLONNA A GIORNO SOTTOPENSILE L 20 H 70 CON 2 RIPIANI OPEN TALL UNIT UNDER WALL UNIT W 20 H 70 WITH 2 SHELVES	<b>535</b>
2	<b>DOC2811C</b>	MENSOLA DI GIUNZIONE L 40 JOINT SHELF W 40	<b>182</b>
1	<b>DOC2951K</b>	COLONNA A GIORNO L 20 H 140 CON 3 RIPIANI OPEN TALL UNIT W 20 H 140 WITH 3 SHELVES	<b>831</b>
1	<b>DOC2171K</b>	PENSILE RIBALTA ANTA LEGNO L 140 WALL UNIT WITH WOODEN DROP-DOWN DOOR W 140 PLAIN	<b>1.197</b>
1	<b>DOC2181K</b>	PENSILE VASISTAS ANTA VETRO L 140 WALL UNIT WITH GLASS LIFT-UP DOOR W 140	<b>1.323</b>
<b>PREZZO TOT. COMPOSIZIONE</b> TOTAL PRICE FOR COMPOSITION			<b>8.267</b>

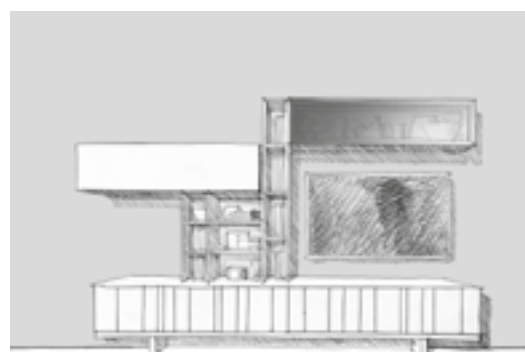

L. W. 300  
P. D. 38/49

# DOMINO SISTEMA COMPONIBILE - MODULAR SYSTEM

## COMPOSIZIONI A CATALOGO

### CATALOGUE COMPOSITIONS

#### COMPOSIZIONE 36

#### COMPOSITION 36

PAG. 16 CATALOGO "PROPOSTE ARREDATIVE"  
PAGE 16 "FURNISHING PROPOSALS" CATALOGUE

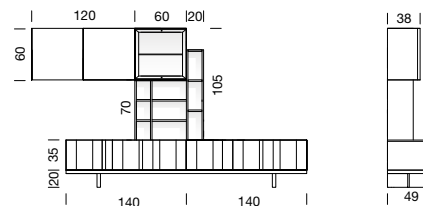
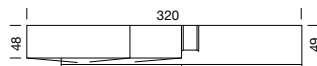

1	<b>DOC3041K</b>	PEDANA L 280 P 49 PLATFORM W 280 D 49	<b>938</b>
2	<b>DOC1086K</b>	BASE CESTONE L 140 P 48 DOGA LEGNO LISCIA BASE UNIT WITH BASKET W 140 D 48 PLAIN WOODEN SLAT	<b>2.864</b>
1	<b>DOC5121K</b>	TOP L 280 P 45 TOP W 280 D 45	<b>397</b>
1	<b>DOC2801K</b>	COLONNA A GIORNO SOTTOPENSILE L 20 H 70 CON 2 RIPIANI OPEN TALL UNIT UNDER WALL UNIT W 20 H 70 CON 2 SHELVES	<b>535</b>
2	<b>DOC2811C</b>	MENSOLA DI GIUNZIONE L 40 JOINT SHELF W 40	<b>182</b>
1	<b>DOC2641K</b>	COLONNA A GIORNO L 20 H 105 CON 2 RIPIANI OPEN TALL UNIT UNDER WALL UNIT W 20 H 105 WITH 2 SHELVES	<b>698</b>
1	<b>DOC2231K</b>	PENSILE ORIZZONTALE 2 ANTE LEGNO L 120 H 60 HORIZONTAL WALL UNIT WITH 2 WOODEN DOORS W 120 H 60	<b>1.479</b>
1	<b>DOC2201K</b>	PENSILE ANTA VETRO DX L 60 H 60 WALL UNIT WITH GLASS DOOR RH W 60 H 60	<b>1.011</b>
<b>PREZZO TOT. COMPOSIZIONE</b> TOTAL PRICE FOR COMPOSITION			<b>8.104</b>



L. W. 320  
P. D. 38/49

#### COMPOSIZIONE 38

#### COMPOSITION 38

PAG. 17 CATALOGO "PROPOSTE ARREDATIVE"  
PAGE 17 "FURNISHING PROPOSALS" CATALOGUE

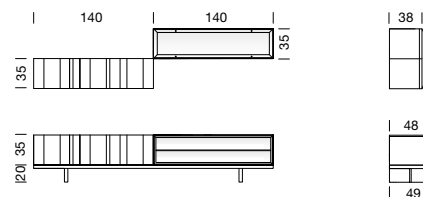
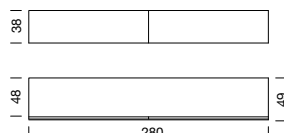

1	<b>DOC3041K</b>	PEDANA L 280 P 49 PLATFORM W 280 D 49	<b>938</b>
1	<b>DOC1086K</b>	BASE CESTONE L 140 P 48 DOGA LEGNO LISCIA BASE UNIT WITH BASKET W 140 D 48 PLAIN WOODEN SLAT	<b>1.432</b>
1	<b>DOC1301K</b>	BASE A GIORNO CON RIPIANO VETRO L 140 P 48 OPEN BASE UNIT WITH GLASS SHELF W 140 D 48	<b>884</b>
1	<b>DOC5121K</b>	TOP L 280 P 45 TOP W 280 D 45	<b>397</b>
1	<b>DOC2176K</b>	PENSILE RIBALTA L 140 DOGA LEGNO LISCIA WALL UNIT DROP-DOWN DOOR W 140 PLAIN WOODEN SLAT	<b>1.564</b>
1	<b>DOC2181K</b>	PENSILE VASISTAS ANTA VETRO L 140 WALL UNIT WITH GLASS LIFT-UP DOOR W 140	<b>1.323</b>
<b>PREZZO TOT. COMPOSIZIONE</b> TOTAL PRICE FOR COMPOSITION			<b>6.538</b>

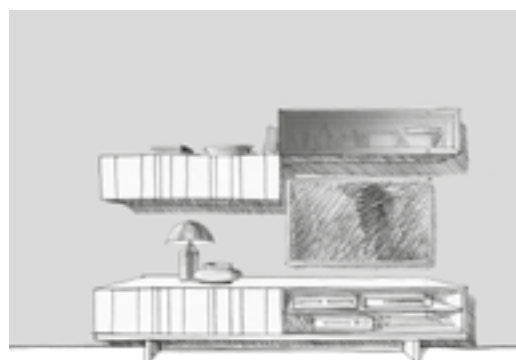

L. W. 280  
P. D. 38/49

#### COMPOSIZIONE 42

#### COMPOSITION 42

PAG. 18 CATALOGO "PROPOSTE ARREDATIVE"  
PAGE 18 "FURNISHING PROPOSALS" CATALOGUE

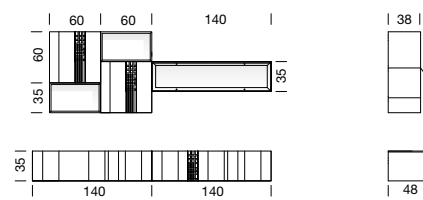
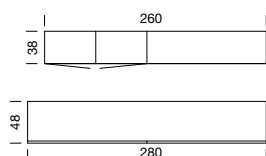

1	<b>DOC1096K</b>	BASE CESTONE SOSPESA L 140 P 48 DOGA LEGNO LISCIA SUSPENDED BASE UNIT WITH BASKET W 140 D 48 PLAIN WOODEN SLAT	<b>1.443</b>
1	<b>DOC1096K</b>	BASE CESTONE SOSPESA L 140 P 48 DOGA QUADRO LEGNO SUSPENDED BASE UNIT WITH BASKET W 140 D 48 SQUARE WOODEN SLAT	<b>1.539</b>
1	<b>DOC5121K</b>	TOP L 280 P 45 TOP W 280 D 45	<b>397</b>
2	<b>DOC2721K</b>	PENSILE A GIORNO L 60 H 35 OPEN WALL UNIT W 60 H 35	<b>974</b>
1	<b>DOC2316K</b>	PENSILE ANTA SX L 60 H 60 DOGA QUADRO LEGNO WALL UNIT WITH DOOR LH W 60 H 60 SQUARE WOODEN SLAT	<b>1.325</b>
1	<b>DOC2216K</b>	PENSILE ANTA DX L 60 H 60 DOGA QUADRO LEGNO WALL UNIT WITH DOOR RH W 60 H 60 SQUARE WOODEN SLAT	<b>1.325</b>
1	<b>DOC2181K</b>	PENSILE VASISTAS ANTA VETRO L 140 WALL UNIT WITH GLASS LIFT-UP DOOR W 140	<b>1.323</b>
<b>PREZZO TOT. COMPOSIZIONE</b> TOTAL PRICE FOR COMPOSITION			<b>8.326</b>

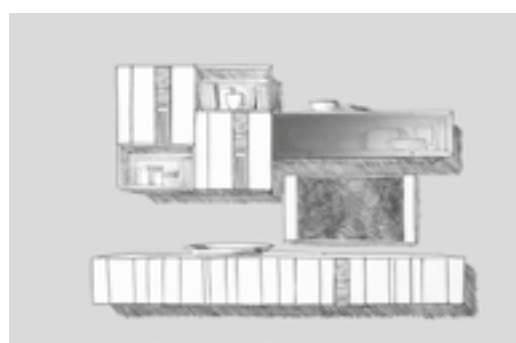

L. W. 280  
P. D. 38/48



## COMPOSIZIONI A CATALOGO CATALOGUE COMPOSITIONS

### COMPOSIZIONE 44 COMPOSITION 44

PAG. 19 CATALOGO "PROPOSTE ARREDATIVE"  
PAGE 19 "FURNISHING PROPOSALS" CATALOGUE

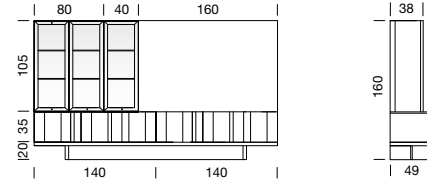
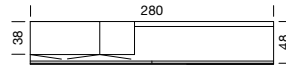

1	<b>DOC3041K</b>	PEDANA L 280 P 49 PLATFORM W 280 D 49	<b>938</b>
2	<b>DOC1086K</b>	BASE CESTONE L 140 P 48 DOGA LEGNO LISCIA BASE UNIT WITH BASKET W 140 D 48 PLAIN WOODEN SLAT	<b>2.864</b>
1	<b>DOC5121K</b>	TOP L 280 P 45 TOP W 280 D 45	<b>397</b>
1	<b>DOC2621K</b>	PENSILE VERTICALE 2 ANTE VETRO L 80 H 105 VERTICAL WALL UNIT WITH 2 GLASS DOORS W 80 H 105	<b>2.116</b>
1	<b>DOC2371K</b>	PENSILE VERTICALE ANTA VETRO SX L 40 H 105 VERTICAL WALL UNIT WITH GLASS DOOR LH W 40 H 105	<b>1.125</b>
1	<b>DOC7081K</b>	BOISERIE L 160 H 105 BOISERIE W 160 H 105	<b>823</b>
<b>PREZZO TOT. COMPOSIZIONE</b> TOTAL PRICE FOR COMPOSITION			<b>8.263</b>

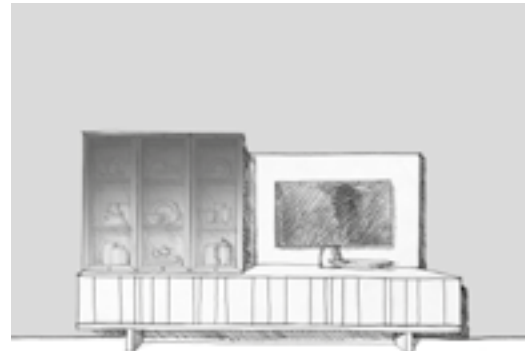

L. W. 280  
P. D. 38/49

### COMPOSIZIONE 46 COMPOSITION 46

PAG. 20 CATALOGO "PROPOSTE ARREDATIVE"  
PAGE 20 "FURNISHING PROPOSALS" CATALOGUE

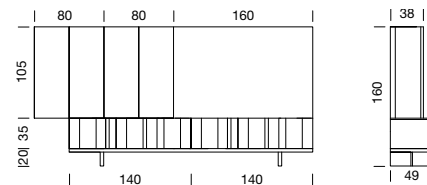
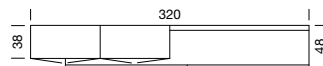

1	<b>DOC3041K</b>	PEDANA L 280 P 49 PLATFORM W 280 D 49	<b>938</b>
2	<b>DOC1086K</b>	BASE CESTONE L 140 P 48 DOGA LEGNO LISCIA BASE UNIT WITH BASKET W 140 D 48 PLAIN WOODEN SLAT	<b>2.864</b>
1	<b>DOC5121K</b>	TOP L 280 P 45 TOP W 280 D 45	<b>397</b>
2	<b>DOC2971K</b>	PENSILE VERTICALE 2 ANTE LEGNO L 80 H 105 VERTICAL WALL UNIT WITH 2 WOODEN DOORS W 80 H 105	<b>3.704</b>
1	<b>DOC7081K</b>	BOISERIE L 160 H 105 BOISERIE W 160 H 105	<b>823</b>
<b>PREZZO TOT. COMPOSIZIONE</b> TOTAL PRICE FOR COMPOSITION			<b>8.726</b>



L. W. 320  
P. D. 38/49

### COMPOSIZIONE 48 COMPOSITION 48

PAG. 21 CATALOGO "PROPOSTE ARREDATIVE"  
PAGE 21 "FURNISHING PROPOSALS" CATALOGUE

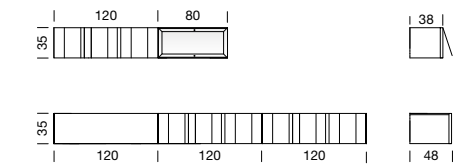
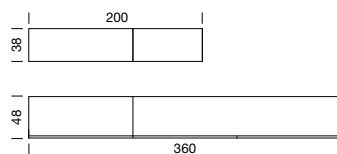

1	<b>DOC1071K</b>	BASE CESTONE SOSPESA L 120 P 48 SUSPENDED BASE UNIT WITH BASKET W 120 D 48	<b>1.070</b>
1	<b>DOC5041K</b>	TOP L 120 P 45 TOP W 120 D 45	<b>175</b>
2	<b>DOC1076K</b>	BASE CESTONE SOSPESA L 120 P 48 DOGA LEGNO LISCIA SUSPENDED BASE UNIT WITH BASKET W 120 D 48 PLAIN WOODEN SLAT	<b>2.730</b>
1	<b>DOC5101K</b>	TOP L 240 P 45 TOP W 240 D 45	<b>349</b>
1	<b>DOC2156K</b>	PENSILE VASISTAS L 120 DOGA LEGNO LISCIA WALL UNIT WITH LIFT-UP DOOR W 120 PLAIN WOODEN SLAT	<b>1.413</b>
1	<b>DOC2101K</b>	PENSILE VASISTAS ANTA VETRO L 80 WALL UNIT WITH GLASS LIFT-UP DOOR W 80	<b>975</b>
<b>PREZZO TOT. COMPOSIZIONE</b> TOTAL PRICE FOR COMPOSITION			<b>6.712</b>

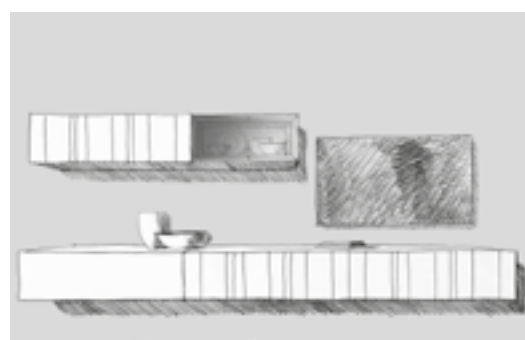

L. W. 360  
P. D. 38/48

# DOMINO SISTEMA COMPONIBILE - MODULAR SYSTEM

## COMPOSIZIONI A CATALOGO

### CATALOGUE COMPOSITIONS

#### COMPOSIZIONE 52

#### COMPOSITION 52

PAG. 22 CATALOGO "PROPOSTE ARREDATIVE"  
PAGE 22 "FURNISHING PROPOSALS" CATALOGUE

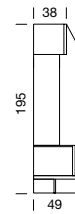
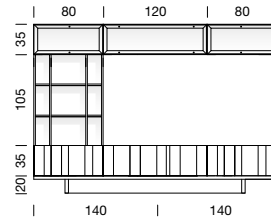
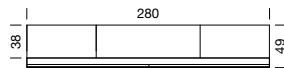

1	<b>DOC3041K</b>	PEDANA L 280 P 49 PLATFORM W 280 D 49	<b>938</b>
2	<b>DOC1086K</b>	BASE CESTONE L 140 P 48 DOGA LEGNO LISCIA BASE UNIT WITH BASKET W 140 D 48 PLAIN WOODEN SLAT	<b>2.864</b>
1	<b>DOC5121K</b>	TOP L 280 P 45 TOP W 280 D 45	<b>397</b>
2	<b>DOC2631K</b>	COLONNA A GIORNO SOTTOPENSILE L 20 H 105 CON 2 RIPIANI OPEN TALL UNIT UNDER WALL UNIT W 20 H 105 WITH 2 SHELVES	<b>1.276</b>
2	<b>DOC2811C</b>	MENSOLA DI GIUNZIONE L 40 JOINT SHELF W 40	<b>182</b>
2	<b>DOC2101K</b>	PENSILE VASISTAS ANTA VETRO L 80 WALL UNIT WITH GLASS LIFT-UP DOOR W 80	<b>1.950</b>
1	<b>DOC2141K</b>	PENSILE VASISTAS ANTA VETRO L 120 WALL UNIT WITH GLASS LIFT-UP DOOR W 120	<b>1.197</b>
<b>PREZZO TOT. COMPOSIZIONE</b> TOTAL PRICE FOR COMPOSITION			<b>8.804</b>

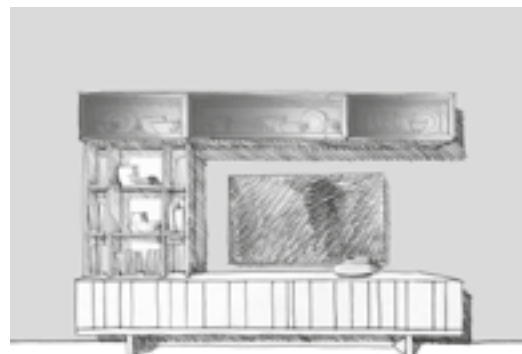

L. W. 280  
P. D. 38/49

#### COMPOSIZIONE 57

#### COMPOSITION 57

PAG. 23 CATALOGO "PROPOSTE ARREDATIVE"  
PAGE 23 "FURNISHING PROPOSALS" CATALOGUE

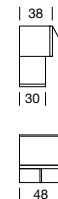
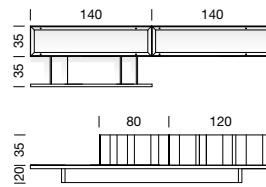
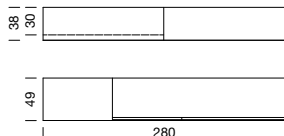

1	<b>DOC3041K</b>	PEDANA L 280 P 49 PLATFORM W 280 D 49	<b>938</b>
1	<b>DOC1046K</b>	BASE CESTONE L 80 P 48 DOGA LEGNO LISCIA BASE UNIT WITH BASKET W 80 D 48 PLAIN WOODEN SLAT	<b>1.160</b>
1	<b>DOC1066K</b>	BASE CESTONE L 120 P 48 DOGA LEGNO LISCIA BASE UNIT WITH BASKET W 120 D 48 PLAIN WOODEN SLAT	<b>1.353</b>
1	<b>DOC5081K</b>	TOP L 200 P 45 TOP W 200 D 45	<b>295</b>
1	<b>DOC3551K</b>	MENSOLA L 140 SHELF W 140	<b>247</b>
2	<b>DOC3981K</b>	DIVISORIO AD U L 20 H 32 U-SHAPED PARTITION W 20 H 32	<b>422</b>
2	<b>DOC2181K</b>	PENSILE VASISTAS ANTA VETRO L 140 WALL UNIT WITH GLASS LIFT-UP DOOR W 140	<b>2.646</b>
<b>PREZZO TOT. COMPOSIZIONE</b> TOTAL PRICE FOR COMPOSITION			<b>7.061</b>

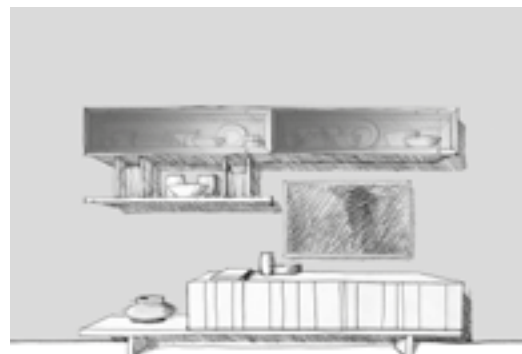

L. W. 280  
P. D. 38/49

#### COMPOSIZIONE 56

#### COMPOSITION 56

PAG. 24 CATALOGO "PROPOSTE ARREDATIVE"  
PAGE 24 "FURNISHING PROPOSALS" CATALOGUE

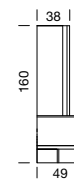
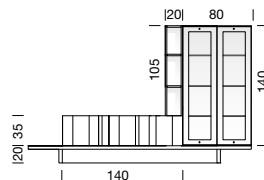
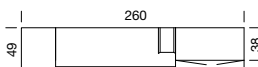

1	<b>DOC3031K</b>	PEDANA L 260 P 49 PLATFORM W 260 D 49	<b>848</b>
1	<b>DOC1086K</b>	BASE CESTONE L 140 P 48 DOGA LEGNO LISCIA BASE UNIT WITH BASKET W 140 D 48 PLAIN WOODEN SLAT	<b>1.432</b>
1	<b>DOC5051K</b>	TOP L 140 P 45 TOP W 140 D 45	<b>206</b>
1	<b>DOC2641K</b>	COLONNA A GIORNO L 20 H 105 CON 2 RIPIANI OPEN TALL UNIT W 20 H 105 WITH 2 SHELVES	<b>698</b>
1	<b>DOC2861K</b>	PENSILE VERTICALE 2 ANTE VETRO L 80 H 140 VERTICAL WALL UNIT WITH 2 GLASS DOORS W 80 H 140	<b>2.314</b>
<b>PREZZO TOT. COMPOSIZIONE</b> TOTAL PRICE FOR COMPOSITION			<b>5.498</b>

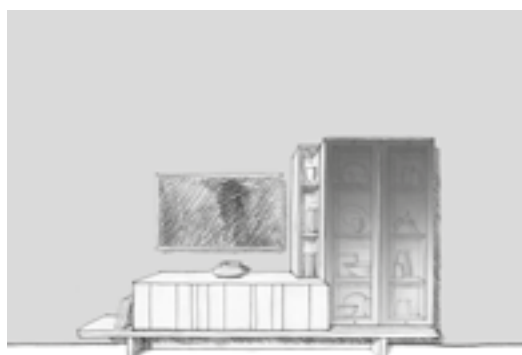

L. W. 260  
P. D. 38/49

## COMPOSIZIONI A CATALOGO CATALOGUE COMPOSITIONS

### COMPOSIZIONE 59

#### COMPOSITION 59

PAG. 25 CATALOGO "PROPOSTE ARREDATIVE"  
PAGE 25 "FURNISHING PROPOSALS" CATALOGUE

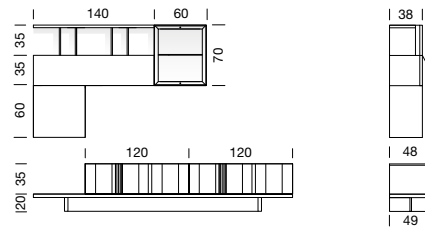
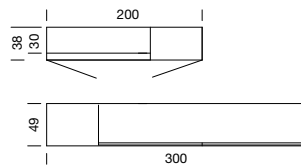

1	<b>DOC3051K</b>	PEDANA L 300 P 49 PLATFORM W 300 D 49	<b>999</b>
2	<b>DOC1066K</b>	BASE CESTONE L 120 P 48 DOGA RIGHE BASE UNIT WITH BASKET W 120 D 48 RIBBED SLAT	<b>2.840</b>
1	<b>DOC5101K</b>	TOP L 240 P 45 TOP W 240 D 45	<b>349</b>
1	<b>DOC2311K</b>	PENSILE ANTA LEGNO SX L 60 H 60 WALL UNIT WITH WOODEN DOOR LH W 60 H 60	<b>848</b>
1	<b>DOC2191K</b>	PENSILE VASISTAS ANTA LEGNO L 140 WALL UNIT WITH WOODEN LIFT-UP DOOR W 140	<b>1.119</b>
2	<b>DOC3981K</b>	DIVISORIO AD U L 20 H 32 U-SHAPED PARTITION W 20 H 32	<b>422</b>
1	<b>DOC3551K</b>	MENSOLA L 140 SHELF W 140	<b>247</b>
1	<b>DOC2291K</b>	PENSILE ANTA VETRO DX L 60 H 70 WALL UNIT WITH GLASS DOOR RH W 60 H 70	<b>1.047</b>
<b>PREZZO TOT. COMPOSIZIONE</b> TOTAL PRICE FOR COMPOSITION			<b>7.871</b>



L. W. 300  
P. D. 38/49

### COMPOSIZIONE 62

#### COMPOSITION 62

PAG. 26 CATALOGO "PROPOSTE ARREDATIVE"  
PAGE 26 "FURNISHING PROPOSALS" CATALOGUE

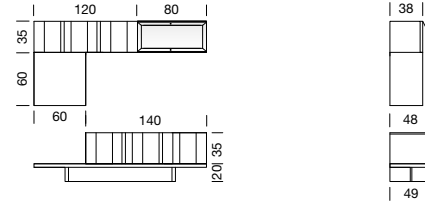
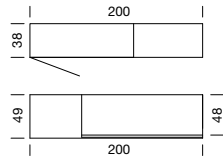

1	<b>DOC3001K</b>	PEDANA L 200 P 49 PLATFORM W 200 D 49	<b>692</b>
1	<b>DOC1086K</b>	BASE CESTONE L 140 P 48 DOGA LEGNO LISCIA BASE UNIT WITH BASKET W 140 D 48 PLAIN WOODEN SLAT	<b>1.432</b>
1	<b>DOC5051K</b>	TOP L 140 P 45 TOP W 140 D 45	<b>206</b>
1	<b>DOC2311K</b>	PENSILE ANTA LEGNO SX L 60 H 60 WALL UNIT WITH WOODEN DOOR LH W 60 H 60	<b>848</b>
1	<b>DOC2156K</b>	PENSILE VASISTAS L 120 DOGA LEGNO LISCIA WALL UNIT WITH LIFT-UP DOOR W 120 PLAIN WOODEN SLAT	<b>1.413</b>
1	<b>DOC2101K</b>	PENSILE VASISTAS ANTA VETRO L 80 WALL UNIT WITH GLASS LIFT-UP DOOR W 80	<b>975</b>
<b>PREZZO TOT. COMPOSIZIONE</b> TOTAL PRICE FOR COMPOSITION			<b>5.566</b>



L. W. 200  
P. D. 38/49

### COMPOSIZIONE 66

#### COMPOSITION 66

PAG. 28 CATALOGO "PROPOSTE ARREDATIVE"  
PAGE 28 "FURNISHING PROPOSALS" CATALOGUE

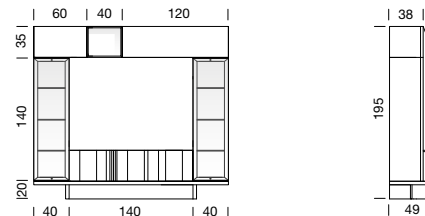
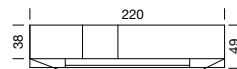

1	<b>DOC3011K</b>	PEDANA L 220 P 49 PLATFORM W 220 D 49	<b>746</b>
1	<b>DOC1086K</b>	BASE CESTONE L 140 P 48 DOGA RIGHE BASE UNIT WITH BASKET W 140 D 48 RIBBED SLAT	<b>1.499</b>
1	<b>DOC5051K</b>	TOP L 140 P 45 TOP W 140 D 45	<b>206</b>
1	<b>DOC2511K</b>	PENSILE VERTICALE ANTA VETRO SX L 40 H 140 VERTICAL WALL UNIT WITH GLASS DOOR LH W 40 H 140	<b>1.275</b>
1	<b>DOC2411K</b>	PENSILE VERTICALE ANTA VETRO DX L 40 H 140 VERTICAL WALL UNIT WITH GLASS DOOR RH W 40 H 140	<b>1.275</b>
1	<b>DOC2071K</b>	PENSILE VASISTAS ANTA LEGNO L 60 WALL UNIT WITH WOODEN LIFT-UP DOOR W 60	<b>735</b>
1	<b>DOC2151K</b>	PENSILE VASISTAS ANTA LEGNO L 120 WALL UNIT WITH WOODEN LIFT-UP DOOR W 120	<b>1.047</b>
1	<b>DOC2711K</b>	PENSILE A GIORNO L 40 H 35 OPEN WALL UNIT W 40 H 35	<b>427</b>
<b>PREZZO TOT. COMPOSIZIONE</b> TOTAL PRICE FOR COMPOSITION			<b>7.210</b>

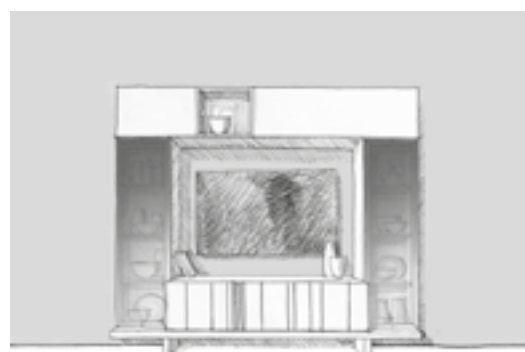

L. W. 220  
P. D. 38/49

# DOMINO SISTEMA COMPONIBILE - MODULAR SYSTEM

## COMPOSIZIONI A CATALOGO

### CATALOGUE COMPOSITIONS

#### COMPOSIZIONE 68

#### COMPOSITION 68

PAG. 29 CATALOGO "PROPOSTE ARREDATIVE"  
PAGE 29 "FURNISHING PROPOSALS" CATALOGUE

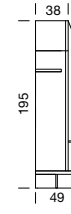
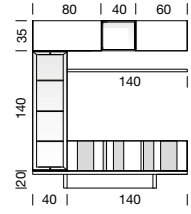
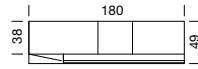

1	<b>DOC3000K</b>	PEDANA L 180 P 49 PLATFORM W 180 D 49	<b>650</b>
1	<b>DOC1086K</b>	BASE CESTONE L 140 P 48 DOGA LEGNO LISCIA - MULTICOLOR BASE UNIT WITH BASKET W 140 D 48 PLAIN WOODEN SLAT - MULTICOLOR	<b>1.504</b>
1	<b>DOC5051K</b>	TOP L 140 P 45 TOP W 140 D 45	<b>206</b>
1	<b>DOC2511K</b>	PENSILE VERTICALE ANTA VETRO SX L 40 H 140 VERTICAL WALL UNIT WITH GLASS DOOR LH W 40 H 140	<b>1.275</b>
1	<b>DOC3551K</b>	MENSOLA L 140 SHELF W 140	<b>247</b>
1	<b>DOC2111K</b>	PENSILE VASISTAS ANTA LEGNO L 80 WALL UNIT WITH WOODEN LIFT-UP DOOR W 80	<b>884</b>
1	<b>DOC2071K</b>	PENSILE VASISTAS ANTA LEGNO L 60 WALL UNIT WITH WOODEN LIFT-UP DOOR W 60	<b>735</b>
1	<b>DOC2711K</b>	PENSILE A GIORNO L 40 H 35 OPEN WALL UNIT W 40 H 35	<b>427</b>
<b>PREZZO TOT. COMPOSIZIONE</b> TOTAL PRICE FOR COMPOSITION			<b>5.928</b>

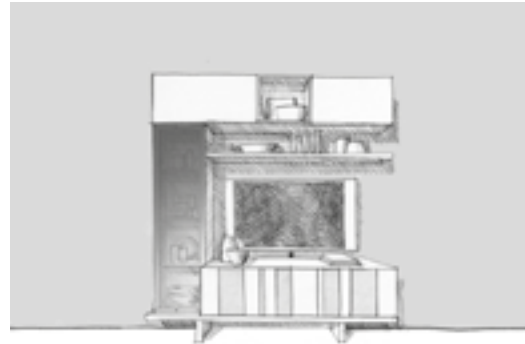

L. W. 180  
P. D. 38/49

#### COMPOSIZIONE 72/A

#### COMPOSITION 72/A

PAG. 30 CATALOGO "PROPOSTE ARREDATIVE"  
PAGE 30 "FURNISHING PROPOSALS" CATALOGUE

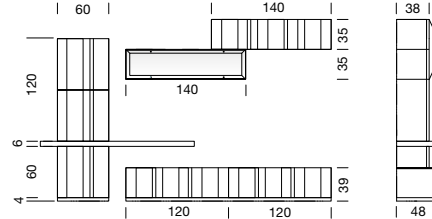
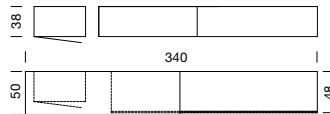

1	<b>DOC3171K</b>	ZOCCOLO L 240 P 45 PLINTH W 240 D 45	<b>349</b>
2	<b>DOC1066K</b>	BASE CESTONE L 120 P 48 DOGA LEGNO LISCIA BASE UNIT WITH BASKET W 120 D 48 PLAIN WOODEN SLAT	<b>2.706</b>
1	<b>DOC5101K</b>	TOP L 240 P 45 TOP W 240 D 45	<b>349</b>
1	<b>DOC3231K</b>	ZOCCOLO L 60 P 35 PLINTH W 60 D 35	<b>181</b>
1	<b>DOC2316K</b>	PENSILE ANTA SX L 60 H 60 DOGA LEGNO LISCIA WALL UNIT WITH DOOR LH W 60 H 60 PLAIN WOODEN SLAT	<b>1.215</b>
1	<b>DOC2686K</b>	PENSILE VERTICALE 2 ANTE SX L 60 H 120 DOGA LEGNO LISCIA VERTICAL WALL UNIT WITH 2 DOORS RH W 60 H 120 PLAIN WOODEN SLAT	<b>2.146</b>
1	<b>DOC3741K</b>	MENSOLONE L 180 P 50 LARGE SHELF W 180 D 50	<b>668</b>
1	<b>DOC2196K</b>	PENSILE VASISTAS L 140 DOGA LEGNO LISCIA WALL UNIT WITH LIFT-UP DOOR W 140 PLAIN WOODEN SLAT	<b>1.473</b>
1	<b>DOC2161K</b>	PENSILE RIBALTA ANTA VETRO L 140 WALL UNIT WITH GLASS DROP-DOWN DOOR W 140	<b>1.401</b>
<b>PREZZO TOT. COMPOSIZIONE</b> TOTAL PRICE FOR COMPOSITION			<b>10.488</b>

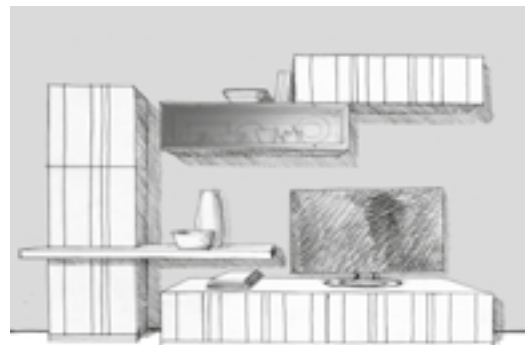

L. W. 340  
P. D. 38/48

#### COMPOSIZIONE 74

#### COMPOSITION 74

PAG. 32 CATALOGO "PROPOSTE ARREDATIVE"  
PAGE 32 "FURNISHING PROPOSALS" CATALOGUE

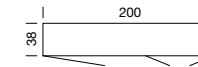

1	<b>DOC3301K</b>	ZOCCOLO L 200 P 35 PLINTH W 200 D 35	<b>326</b>
1	<b>DOC1376K</b>	BASE CESTONE L 120 P 38 DOGA LEGNO LISCIA BASE UNIT WITH BASKET W 120 D 38 PLAIN WOODEN SLAT	<b>1.341</b>
1	<b>DOC2621K</b>	PENSILE VERTICALE 2 ANTE VETRO L 80 H 105 VERTICAL WALL UNIT WITH 2 GLASS DOORS W 80 H 105	<b>2.116</b>
1	<b>DOC2541K</b>	PENSILE ORIZZONTALE ANTA LEGNO SX L 80 H 70 HORIZONTAL WALL UNIT WITH WOODEN DOOR LH W 80 H 70	<b>981</b>
1	<b>DOC2741K</b>	PENSILE A GIORNO L 40 H 105 OPEN TALL UNIT W 40 H 105	<b>662</b>
1	<b>DOC2096K</b>	PENSILE RIBALTA L 80 DOGA LEGNO LISCIA WALL UNIT WITH DROP-DOWN DOOR W 80 PLAIN WOODEN SLAT	<b>1.167</b>
1	<b>DOC2771K</b>	PENSILE A GIORNO CON CORNICE L 80 P 38 OPEN WALL UNIT WITH FRAME W 80 D 38	<b>722</b>
1	<b>DOC5371K</b>	TOP PER PENSILI L 200 P 38 TOP W 200 D 38	<b>289</b>
<b>PREZZO TOT. COMPOSIZIONE</b> TOTAL PRICE FOR COMPOSITION			<b>7.604</b>



L. W. 200  
P. D. 38

## COMPOSIZIONI A CATALOGO CATALOGUE COMPOSITIONS

### COMPOSIZIONE 76 COMPOSITION 76

PAG. 33 CATALOGO "PROPOSTE ARREDATIVE"  
PAGE 33 "FURNISHING PROPOSALS" CATALOGUE

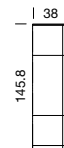
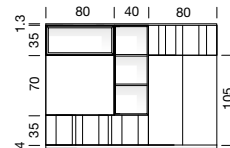
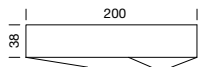

1	<b>DOC3301K</b>	ZOCCOLO L 200 P 35 PLINTH W 200 D 35	<b>326</b>
1	<b>DOC1376K</b>	BASE CESTONE L 120 P 38 DOGA LEGNO LISCIA BASE UNIT WITH BASKET W 120 D 38 PLAIN WOODEN SLAT	<b>1.341</b>
1	<b>DOC2971K</b>	PENSILE VERTICALE 2 ANTE LEGNO L 80 H 105 VERTICAL WALL UNIT WITH 2 WOODEN DOORS W 80 H 105	<b>1.852</b>
1	<b>DOC2541K</b>	PENSILE ORIZZONTALE ANTA LEGNO SX L 80 H 70 HORIZONTAL WALL UNIT WITH WOODEN DOOR LH W 80 H 70	<b>981</b>
1	<b>DOC2741K</b>	PENSILE A GIORNO L 40 H 105 OPEN TALL UNIT W 40 H 105	<b>662</b>
1	<b>DOC2096K</b>	PENSILE RIBALTA L 80 DOGA LEGNO LISCIA WALL UNIT WITH DROP-DOWN DOOR W 80 PLAIN WOODEN SLAT	<b>1.167</b>
1	<b>DOC2771K</b>	PENSILE A GIORNO CON CORNICE L 80 P 38 OPEN WALL UNIT WITH FRAME W 80 D 38	<b>722</b>
1	<b>DOC5371K</b>	TOP PER PENSILI L 200 P 38 TOP W 200 D 38	<b>289</b>
<b>PREZZO TOT. COMPOSIZIONE</b> TOTAL PRICE FOR COMPOSITION			<b>7.340</b>



L. W. 200  
P. D. 38

### COMPOSIZIONE 78 COMPOSITION 78

PAG. 34 CATALOGO "PROPOSTE ARREDATIVE"  
PAGE 34 "FURNISHING PROPOSALS" CATALOGUE

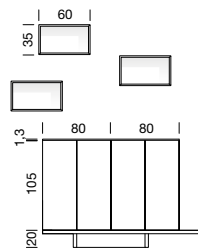
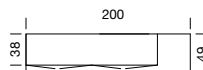

1	<b>DOC3001K</b>	PEDANA L 200 P 49 PLATFORM W 200 D 49	<b>692</b>
2	<b>DOC2971K</b>	PENSILE VERTICALE 2 ANTE LEGNO L 80 H 105 VERTICAL WALL UNIT WITH 2 WOODEN DOORS W 80 H 105	<b>3.704</b>
1	<b>DOC5351K</b>	TOP PER MADIE COMPONIBILI L 160 P 38 TOP FOR MODULAR CUPBOARDS W 160 D 38	<b>253</b>
3	<b>DOC2721K</b>	PENSILE A GIORNO L 60 H 35 OPEN WALL UNIT W 60 H 35	<b>1.461</b>
<b>PREZZO TOT. COMPOSIZIONE</b> TOTAL PRICE FOR COMPOSITION			<b>6.110</b>



L. W. 200  
P. D. 38/49

### COMPOSIZIONE 80 COMPOSITION 80

PAG. 35 CATALOGO "PROPOSTE ARREDATIVE"  
PAGE 35 "FURNISHING PROPOSALS" CATALOGUE

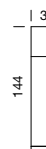
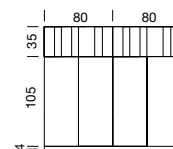
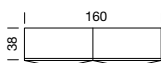

1	<b>DOC3281K</b>	ZOCCOLO L 160 P 35 PLINTH W 160 D 35	<b>259</b>
2	<b>DOC2971K</b>	PENSILE VERTICALE 2 ANTE LEGNO L 80 H 105 VERTICAL WALL UNIT WITH 2 WOODEN DOORS W 80 H 105	<b>3.704</b>
2	<b>DOC2096K</b>	PENSILE RIBALTA L 80 DOGA LEGNO LISCIA WALL UNIT WITH DROP-DOWN DOOR W 80 PLAIN WOODEN SLAT	<b>2.334</b>
<b>PREZZO TOT. COMPOSIZIONE</b> TOTAL PRICE FOR COMPOSITION			<b>6.297</b>

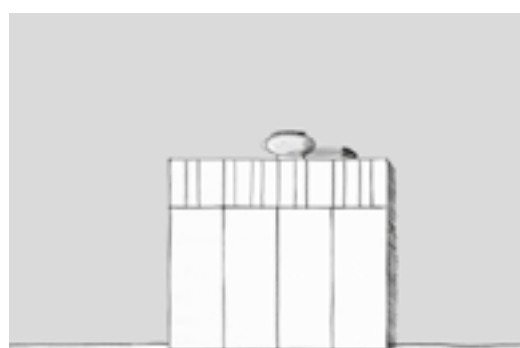

L. W. 180  
P. D. 38





**PREZZI DA APPLICARE PER PRODOTTI FUORI STANDARD O "SU MISURA"**

**COSA SI DEVE INTENDERE PER FUORI STANDARD:**

SI INTENDONO TUTTI I PRODOTTI A LISTINO CON DIMENSIONI INFERIORI RISPETTO A QUANTO ESPOSTO NEL MEDESIMO.

PER TALI PRODOTTI DOVRANNO ESSERE APPLICATE LE SEGUENTI MAGGIORAZIONI:

- + 30 %** RISPETTO AL PREZZO DI LISTINO PER UN SOLO TAGLIO (ES: LARGHEZZA, PROFONDITÀ O ALTEZZA)
- + 40 %** RISPETTO AL PREZZO DI LISTINO SE LE RIDUZIONI SONO DI 2 O 3 TAGLI (ES: LARGHEZZA E PROFONDITÀ O LARGHEZZA E ALTEZZA ECC)

**PER RICHIESTE DI PRODOTTI CON DIMENSIONI SUPERIORI RISPETTO A QUELLE STANDARD DEL LISTINO DEVE ESSERE RICHIESTO IL PREVENTIVO ALL'AZIENDA, IN QUANTO COMPORTA MOLTE VARIABILI.**

**PER MODIFICHE RELATIVE ALLA LUCIDATURA DOVRANNO ESSERE CONSIDERATE LE SEGUENTI MAGGIORAZIONI:**

- + 10 %** PER LACCATO OPACO COPRENTE COLORI DA CAMPIONARIO MODO10
- + 10 %** PER FINITURA VERNICIATA A CAMPIONE

**GLI ORDINI CON MISURE SPECIALI, ACCETTATI DALL'AZIENDA, SI DEVONO RITENERE IRREVOCABILI.**

**SI RICHIEDE INOLTRE PER GLI STESSI UN PAGAMENTO ANTICIPATO ALL'ORDINE PARI AL 30% DELL'IMPORTO DOVUTO.**

**PER CONSEGNE DI IMPORTI INFERIORI A 600 EURO NETTI A MEZZO BIANCHINI SRL, È PREVISTO UN CONTRIBUTO SPESE DI TRASPORTO PARI A 60 EURO.**

**PER CONSEGNE DI IMPORTI INFERIORI A 600 EURO NETTI A MEZZO CORRIERE ESPRESSO, VERRÀ CALCOLATO IL PREZZO DEL CORRIERE**

**PER IMBALLO IN CASSE DI LEGNO CALCOLARE UNA MAGGIORAZIONE SUL PREZZO DI LISTINO DI +15%**

**PRICES FOR OUT OF STANDARD OR "MADE-TO-MEASURE" PRODUCTS**

**WHAT DO YOU MEAN FOR OUT OF STANDARD:**

THIS REFERS TO ALL PRODUCTS IN THE PRICE LIST WITH SMALLER DIMENSIONS THAT THOSE GIVEN.

FOR THESE PRODUCTS THE FOLLOWING SURCHARGES ARE APPLICABLE:

- + 30 %** ON THE LIST PRICE FOR A SINGLE CUTTING OPERATION (E.G. WIDTH, DEPTH OR HEIGHT).
- + 40 %** ON THE LIST PRICE IF THERE ARE 2 OR 3 CUTTING OPERATIONS (E.G. WIDTH AND DEPTH OR WIDTH AND HEIGHT, ETC.)

**FOR PRODUCTS BIGGER THAN STANDARD IN THE PRICE LIST, PLEASE APPLY TO THE COMPANY FOR AN ESTIMATE, AS MANY VARIABLES ARE INVOLVED.**

**FOR POLISHING MODIFICATIONS CONSIDER THE FOLLOWING SURCHARGES:**

- + 10 %** FOR ONE-COAT PAINTED FINISH IN MATT MODO10 SAMPLER
- + 10 %** FOR SAMPLE PAINTED FINISH

**WHEN ORDERS FOR SPECIAL MEASUREMENTS ARE ACCEPTED BY THE COMPANY, THEY ARE IRREVOCABLE.**

**WHEN SUCH ORDERS ARE PLACED AN ADVANCE PAYMENT OF 30% OF THE AMOUNT DUE IS REQUIRED.**

**FOR DELIVERIES AMOUNTING TO LESS THAN 600 EURO (NET PRICE), A 60 EURO CONTRIBUTION TO THE TRANSPORT COSTS IS FORESEEN.**

**FOR DELIVERIES OF AMOUNTS LESS THAN 600 EUROS NET BY EXPRESS COURIER, THE COURIER PRICE WILL BE CALCULATED**

**FOR PACKAGING IN WOODEN CRATES CALCULATE AN INCREASE ON THE LIST PRICE OF + 15%**

## CONDIZIONI GENERALI DI VENDITA

---

VALIDITÀ: IL PRESENTE LISTINO ANNULLA E SOSTITUISCE TUTTI I PRECEDENTI A DECORRE DAL 15 NOVEMBRE 2022.

LA BIANCHINI S.R.L. SI RISERVA IL DIRITTO DI APPORTARVI IN QUALUNQUE MOMENTO E SENZA PREAVVISO TUTTE LE MODIFICHE CHE SI RENDONO OPPORTUNE, DECLINANDO OGNI RESPONSABILITÀ PER EVENTUALI INESATTEZZE IN ESSO CONTENUTE, SE DERIVANTI DA ERRORI DI STAMPA O TRASCRIZIONE.

I PREZZI, ESPRESSI IN EURO SI INTENDONO AL PUBBLICO ESCLUSA IVA.

LE MISURE SONO ESPRESSE IN CM.

I DISEGNI DELLE SCHEDE TECNICHE E DEL LISTINO VENDITA E LE FOTO DELLE COMPOSIZIONI SONO INDICATIVE E NON RAPPRESENTANO L'EFFETTIVA ESTETICA DEL PRODOTTO. LA BIANCHINI S.R.L. SI RISERVA DI MODIFICARE, PER NECESSITÀ TECNICHE O MIGLIORAMENTI, I PRODOTTI SENZA PREAVVISO. NON SARÀ ACCETTATA ALCUNA CONTESTAZIONE PER L'INTERPRETAZIONE DI DISEGNI O PER LE MODIFICHE APPORTATE AD OGNI SINGOLO ELEMENTO.

OGGETTO: L'OGGETTO DELLA FORNITURA E IL PREZZO DELLA STESSA VENGONO ESPRESSAMENTE INDICATI DALLA PRESENTE SCRITTURA. TUTTO QUANTO NON SPECIFICAMENTE INDICATO S'INTENDE ESCLUSO. LA MODIFICA ANCHE DI UNA SOLA VOCE, SALVO PATTO CONTRARIO, FA DECADERE DA OGNI IMPEGNATIVA DI PREZZO ED OGNI VARIAZIONE O AGGIUNTA RISPETTO A QUANTO NOMINATO, SARÀ IN OGNI CASO A CARICO DEL CLIENTE.

ORDINI: GLI ORDINI SONO ACCETTATI SALVO APPROVAZIONE DELL'AZIENDA. LA BIANCHINI S.R.L. AD ORDINE ACCETTATO INVIERÀ UNA CONFERMA D'ORDINE AL CLIENTE. TRASCORSI 5 GIORNI DAL RICEVIMENTO DI QUEST'ULTIMA, L'ORDINE SI RITERRÀ VALIDO IN TUTTE LE SUE PARTI, PERTANTO NON SARANNO PIÙ ACCETTATI ANNULLAMENTI O MODIFICHE.

CONSEGNA: I TERMINI DI CONSEGNA ASSUMONO PER L'AZIENDA VALORE PURAMENTE INDICATIVO E NON VINCOLANTE.

PRODOTTO: I DATI TECNICI RELATIVI AI PRODOTTI RIPORTATI NEL PRESENTE LISTINO SONO PURAMENTE INDICATIVI. LA BIANCHINI S.R.L. SI RISERVA LA FACOLTÀ DI APPORTARE TUTTE LE MODIFICHE CHE RITERRÀ OPPORTUNE E NECESSARIE.

BOX CAMPIONARI: NON DEVE INTENDERSI IN SENSO TASSATIVO, IN QUANTO SUSSISTONO MARGINI DI TOLLERANZA DOVUTI A VARIAZIONI DEL PRODOTTO (COLORI, MATERIALI, MISURE, ECC.) OPPURE PRINCIPALMENTE DA FATTORI AMBIENTALI (UMIDITÀ, LUCE, ECC.).

CARATTERISTICHE DEL PRODOTTO: IL PRINCIPALE COMPONENTE UTILIZZATO NELLA COSTRUZIONE DEGLI ARREDI È IL LEGNO. IL LEGNO ESSENDO UN PRODOTTO NATURALE PUÒ CONTENERE DELLE DIFFORMITÀ DI VENATURA E DI TONALITÀ CHE SONO GARANZIA PROPRIA DEL MATERIALE STESSO E QUINDI NON DEVONO ESSERE INTESI COME DIFETTOSITÀ.

LA BIANCHINI S.R.L. NON GARANTISCE L' UNIFORMITÀ DELLA VENATURA DEL LEGNO E/O DEL COLORE PER MOBILI DI COLLEZIONI DIFFERENTI CHE VENGONO ABBINATI E NON SI ASSUME LA RESPONSABILITÀ DELLE DIFFERENZE CROMATICHE POSSIBILI IN CASO DI ORDINI PER COMPLETAMENTO O SOSTITUZIONE.

CONSISTENZA DELLE PARETI MURARIE: LA TENUTA DEI DISPOSITIVI DI FISSAGGIO È SUBORDINATA ALLA CONSISTENZA DELLE PARETI MURARIE/SOFFITTI/PAVIMENTI A CUI GLI STESSI SONO APPLICATI.

INSTALLAZIONE: È IMPORTANTE CHE VENGA ESEGUITA DA PERSONE REALMENTE COMPETENTI; SI DECLINA OGNI RESPONSABILITÀ PER ERRATI MONTAGGI DA PARTE DEL RIVENDITORE O DI TERZI E PER GLI EVENTUALI DANNI CONSEGUENTI.

NESSUN DANNO DIRETTO O INDIRETTO PUÒ ESSERE RICHIESTO PER MANCATA O RITARDATA CONSEGNA.

TRASPORTO: LA MERCE SE VENDUTA FRANCO FABBRICA VIAGGIA A RISCHIO E PERICOLO DEL CLIENTE MENTRE, SE VENDUTA FRANCO DESTINO, VIAGGIA A RISCHIO E PERICOLO DELL'AZIENDA FIN DOVE ARRIVANO GLI AUTOMEZZI SU SPONDA CAMION. VERRANNO ADDEBITATI GLI EVENTUALI COSTI DI FACCHINAGGIO PER IL POSIZIONAMENTO DELLA MERCE NEL MAGAZZINO DEL CLIENTE.

RECLAMI: I RECLAMI SONO AMMESSI SOLO SE FATTI ENTRO OTTO GIORNI DALLA DATA DI CONSEGNA. TRASCORSO TALE PERIODO L'AZIENDA DECLINA OGNI RESPONSABILITÀ. PER EVENTUALI DANNI CAUSATI ALLA MERCE DURANTE IL TRASPORTO, O COLLI MANCANTI, I RECLAMI DOVRANNO ESSERE MANIFESTATI AL VETTORE AL RICEVIMENTO DELLA MERCE. IL DOCUMENTO DI TRASPORTO FIRMATO AL MOMENTO DELLO SCARICO VALE COME DICHIARAZIONE DI ESATTA CORRISPONDENZA DI QUANTO IN ESSO CONTENUTO.

PAGAMENTI: PER NESSUN MOTIVO ED A NESSUN TITOLO IL CLIENTE PUÒ DIFFERIRE O SOSPENDERE I PAGAMENTI OLTRE LE SCADENZE PATTUITE IN FATTURA; IL MANCATO O RITARDATO PAGAMENTO ANCHE DI UNA SOLA RATA COMPORTERÀ LA DECADENZA DAL BENEFICIO DI TUTTI I TERMINI PATTUITI, RENDENDO IMMEDIATAMENTE ESIGIBILE L'INTERO CREDITO CON L'ADDEBITO DEGLI INTERESSI DI MORA PREVISTI PER LEGGE. IN QUALSIASI FORMA SIA CONVENUTO IL PAGAMENTO, SONO A CARICO DEL CLIENTE TUTTE LE SPESE PER GLI ONERI RELATIVI, COSÌ COME I RISCHI PER FURTI E/O SMARRIMENTI DEI TITOLI DURANTE LA CIRCOLAZIONE POSTALE E/O BANCARIA. GLI EFFETTI SONO DA NOI ACCETTATI SALVO BUON FINE E NON COSTITUISCONO NOVAZIONE DI CREDITO.

RESI: NON SI ACCETTANO RESI DI MERCE SE NON AUTORIZZATI DALL'AZIENDA. I RESI ACCETTATI DALL'AZIENDA DEVONO ESSERE INTEGRI, IMBALLATI E ACCOMPAGNATI DA REGOLARE DOCUMENTO DI TRASPORTO. IL TRASPORTO È A CARICO DEL CLIENTE. I PRODOTTI RESI VENGONO ACCREDITATI ALLO STESSO PREZZO PAGATO IN FATTURA AL MOMENTO DELL'ACQUISTO, ADDEBITANDO LE EVENTUALI PARTI DANNEGGIATE O DIFETTATE. SI PRECISA CHE NON VERRANNO ACCETTATI RESI DI ELEMENTI REALIZZATI SU MISURA.

LEGGE APPLICABILE E FORO COMPETENTE: LE VENDITE SOTTOPOSTE ALLE PRESENTI CONDIZIONI GENERALI SONO REGOLATE DAL DIRITTO ITALIANO, E, OVE APPLICABILE, DALLA CONVENZIONE DI VIENNA DELL'11 APRILE 1980, SULLA VENDITA INTERNAZIONALE. OGNI CONTROVERSIA TRA LE PARTI IN RELAZIONE ALLE VENDITE SARÀ DI COMPETENZA DEL FORO DI VERONA (ITALIA).



## GENERAL CONDITIONS OF SALE

---

VALIDITY: THIS PRICE LIST REPEALS AND REPLACES ALL PREVIOUS ONES STARTING FROM 15 NOVEMBER 2022.

BIANCHINI S.R.L. RESERVES THE RIGHT TO MAKE ANY NECESSARY CHANGE AT ANY TIME AND WITHOUT PRIOR NOTICE AND DOES NOT TAKE ANY RESPONSIBILITY FOR ANY INACCURACY WHEN CAUSED BY TYPING OR TRANSCRIPTION ERRORS

PRICES, EXPRESSED IN EUROS ARE INTENDED TO THE PUBLIC EXCLUDED VAT.

DIMENSIONS ARE IN CM.

THE DRAWINGS IN THE TECHNICAL SHEETS AND THE PRICE LIST AS WELL AS THE PHOTOS OF THE COMPOSITIONS ARE INDICATIVE AND DO NOT REPRESENT THE ACTUAL LOOK OF THE PRODUCT. BIANCHINI S.R.L. RESERVES THE RIGHT TO MODIFY THE PRODUCTS, FOR TECHNICAL REASONS OR FOR IMPROVEMENT, WITHOUT PRIOR NOTICE. NO CLAIM SHALL BE ACCEPTED ON THE INTERPRETATION OF DRAWINGS OR ON THE CHANGES MADE TO EACH SINGLE ITEM.

OBJECT: THE GOODS TO BE DELIVERED AND THEIR PRICE ARE EXPRESSLY MENTIONED IN THIS DOCUMENT. ANYTHING THAT IS NOT SPECIFIED SHALL BE UNDERSTOOD AS NOT INCLUDED.

THE CHANGE OF EVEN ONE SINGLE ITEM, IF NOT AGREED OTHERWISE, SHALL MAKE VOID ANY PRICE AGREEMENT AND EACH SINGLE VARIATION OR ADDITION TO WHAT IS LISTED WILL BE IN ANY CASE CHARGED TO THE CUSTOMER.

ORDERS: ORDERS ARE ACCEPTED ONLY ON APPROVAL BY THE COMPANY. AFTER ACCEPTING THE ORDER, BIANCHINI S.R.L. WILL SEND A CONFIRMATION OF ORDER TO THE CUSTOMER. AFTER 5 DAYS FROM RECEPTION OF THE CONFIRMATION OF ORDER, THE ORDER WILL BE CONSIDERED VALID IN ALL ITS PARTS AND THEREFORE NON CANCELLATIONS OR CHANGES WILL BE ACCEPTED ANY LONGER.

DELIVERY: THE DELIVERY TERM IS MERELY INDICATIVE FOR THE COMPANY AND IS NOT BINDING.

PRODUCT: THE TECHNICAL DATA CONCERNING THE PRODUCTS AND PROVIDED IN THIS PRICE LIST ARE MERELY INDICATIVE. BIANCHINI S.R.L. RESERVES THE RIGHT TO MAKE ANY CHANGE IT WILL CONSIDER APPROPRIATE AND NECESSARY.

SAMPLES BOX: IT SHALL NOT BE UNDERSTOOD IN ABSOLUTE TERMS SINCE THERE ARE TOLERANCES LINKED TO SLIGHT DIFFERENCES IN THE PRODUCTS – COLOURS, MATERIALS, SIZE, ETC. – OR MAINLY DUE TO ENVIRONMENTAL FACTORS SUCH AS HUMIDITY, LIGHT, ETC.

PRODUCT CHARACTERISTICS: THE MAIN MATERIAL USED TO MAKE THE FURNITURE IS WOOD. WOOD IS A NATURAL PRODUCT AND THEREFORE CAN SHOW DIFFERENT GRAINS AND COLOUR SHADES THAT ARE A GUARANTEE OF THE MATERIAL AND MUST NOT BE CONSIDERED AS DEFECTS.

BIANCHINI S.R.L. DOES NOT GUARANTEE UNIFORM WOOD GRAIN AND/OR COLOUR FOR FURNITURE UNITS BELONGING TO DIFFERENT COLLECTIONS AND THAT ARE PUT IN THE SAME COMPOSITION. MOREOVER, IT DOES NOT TAKE ANY RESPONSIBILITY FOR DIFFERENCES IN COLOUR THAT CAN EMERGE IN CASE OF ORDERS MADE TO COMPLETE A COMPOSITION OR TO REPLAC AN ITEM.

COMPACTNESS OF WALLS: THE HOLD OF THE FASTENING DEVICES DEPENDS ON THE COMPACTNESS OF WALLS/CEILINGS/FLOORS TO WHICH THE DEVICES ARE APPLIED.

INSTALLATION: IT IS IMPORTANT THAT THE ASSEMBLY IS PERFORMED BY SKILLED PERSONNEL. NO LIABILITY IS TAKEN FOR WRONG ASSEMBLY BY THE DEALER OR THIRD PARTIES AND FOR ANY DAMAGE DERIVING FROM IT.

NO DIRECT OR INDIRECT DAMAGE CLAIM CAN BE RAISED FOR LATE OR NO DELIVERY.

TRASPORT: WHEN THE GOODS ARE DELIVERED EX WORKS, THE TRANSPORT RISKS ARE BORNE BY THE CUSTOMER. WHEN THE GOODS ARE DELIVERED FREE AT DESTINATION, THE TRANSPORT RISKS ARE BORNE BY THE COMPANY UP TO THE POINT WHERE THE TRUCK CAN REACH. ANY COSTS FOR UNLOADING AND POSITIONING THE GOODS IN THE CUSTOMER'S WAREHOUSE WILL BE CHARGED TO THE CUSTOMER.

COMPLAINTS: CLAIMS ARE POSSIBLE ONLY IF RAISED WITHIN EIGHT DAYS FROM THE DATE OF DELIVERY.

AFTER THE EXPIRATION OF THIS TERM, THE COMPANY SHALL NOT TAKE ANY LIABILITY.

IN CASE OF DAMAGE CAUSED TO THE GOODS DURING TRANSPORTATION OR FOR MISSING ITEMS, CLAIMS SHALL BE RAISED TO THE CARRIER WHEN RECEIVING THE GOODS. THE TRASNPOT DOCUMENT THAT SHALL BE SIGNED WHEN UNLOADING THE GOODS AND SHALL BE CONSIDERED AS A DECLARATION THAT THE GOODS EXACTLY CORRESPOND TO WHAT IS LISTED ON THE DOCUMENT.

PAYMENTS: FOR NO REASON THE CUSTOMER HAS THE RIGHT TO DELAY OR SUSPEND PAYMENTS BEYOND THE TERMS AGREED IN THE INVOICE.

THE DELAYED PAYMENT OR NON-PAYMENT OF EVEN ONE SINGLE INSTALMENT SHALL CAUSE THE LOSS OF ELIGIBILITY TO THE CONDITIONS AGREED AND THE ENTIRE AMOUNT SHALL BE IMMEDIATELY PAYABLE WITH THE ADDITION OF THE LATE PAYMENT INTERESTS ENVISAGED BY THE LAW.

IRRESPECTIVE OF THE TYPE OF PAYMENT AGREED, ALL COSTS AND RELATED BURDENS ARE BORNE BY THE CUSTOMER AS WELL AS THE RISK OF THEFT AND/OR LOSS OF THE TITLES WHEN IN THE POST AND/OR BANK CIRCUIT.

BANKER'S DRAFTS ARE ACCEPTED SUBJECT TO COLLECTION AND ARE NOT CONSIDERED AS A RENEWAL OF CREDIT.

RETURNS: THE GOODS CANNOT BE RETURNED WITHOUT COMPANY AUTHORISATION.

RETURNED GOODS AUTHORISED BY THE COMPANY SHALL BE UNDAMAGED, PACKED AND ACCOMPANIED BY THE TRANSPORT DOCUMENT ENVISAGED BY THE LAW. THE TRANSPORT SHALL BE CHARGED TO THE CUSTOMER.

RETURNED GOODS ARE REIMBURSED AT THE SAME PRICE FEATURING IN THE SALE INVOICE.

THE COSTS RELATED TO ANY DAMAGED OR DEFECT PARTS SHALL BE CHARGED TO THE CUSTOMER. MADE-TO-MEASURE ITEMS CANNOT BE RETURNED.

APPLICABLE LAW AND COMPETENT JURISDICTION: THE SALES REGULATED BY THESE GENERAL CONDITIONS ARE GOVERNED BY THE ITALIAN LAW AND, WHERE APPLICABLE, BY THE VIENNA CONVENTION OF 11 APRIL 1980 ON INTERNATIONAL SALES. ANY DISPUTE BETWEEN THE PARTIES CONCERNING THE SALES WILL BE UNDER THE JURISDICTION OF THE COURT OF VERONA (ITALY).

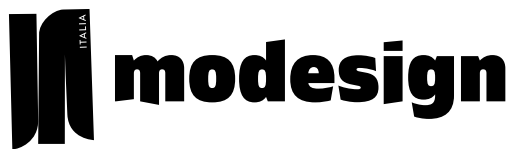

## MODESIGN

VIA G. AMENDOLA, 25 37052 CASALEONE (VR) ITALIA

PHONE +39.0442.333219 FAX +39.0442.330694

[www.modesignitalia.it](http://www.modesignitalia.it)

[info@modesignitalia.it](mailto:info@modesignitalia.it)

MARCHIO DI PROPRIETÀ: BIANCHINI S.R.L.



Materiali certificati e garantiti dal marchio VERO LEGNO.

All materials are certified and guaranteed by the VERO LEGNO (real wood) trademark.

FOLLOW US:



Le foto devono essere considerate come indicative e non costituiscono impegno per il produttore e/o Distributore. Per ragioni tecniche il produttore si riserva di modificare le caratteristiche dei prodotti senza preavviso.

The pictures are to be considered as illustrative only and are not binding for the Manufacturer and/or the Distributor. For technical reasons, the Manufacturer reserves the right to modify the characteristics of the products without previous notice.

**TESSUTI E PELLI**  
**FABRICS AND LEATHER**

**ECOPELLE | ECOLEATHER** H. 140 | 69% PVC, 10% CO, 20% PES, 1% PU | Senza ftalati - phthalate free | PVC made in Italy, ignifugo classe (1IM) - Made in Italy PVC, fire resistant class (1IM) **CAT. A**



**ECONABUK** **MADE IN ITALY** H. 140 | 55% POL, 35% PU, 10% CO | Idrorepellente, facile da pulire - Water repellent, easy to clean **CAT. A**

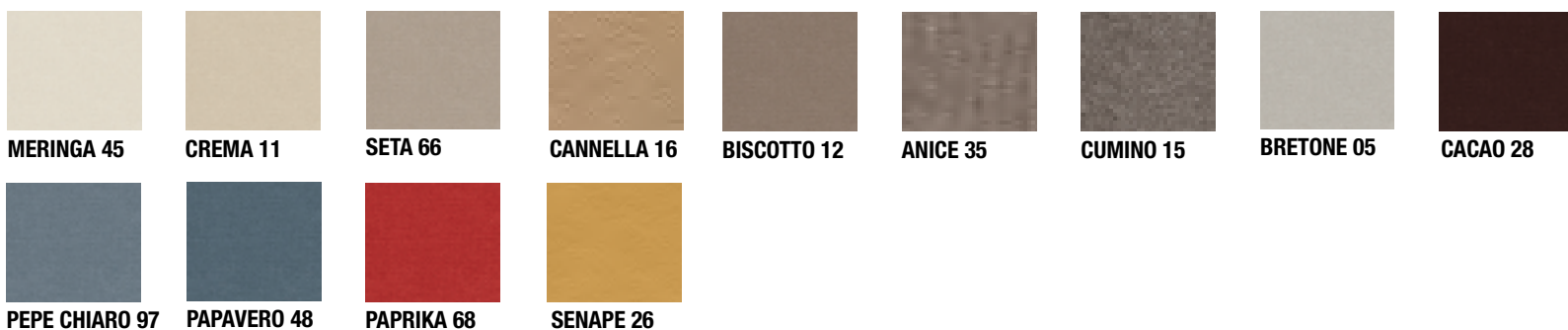

**VELLUTO | VELVET** **MADE IN ITALY** H. 140 | 100% PL accoppiato cotone | Idrorepellente - Water repellent |  **CAT. B**



**LINO | LINEN** **MADE IN ITALY** H. 140 | 100% LI | Prelavato - Prewashed |  **CAT. B**



**PELLE | LEATHER** **MADE IN ITALY** **CAT. C**



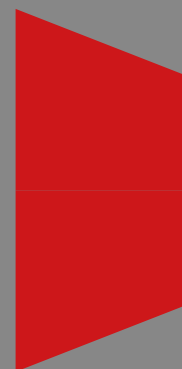

[WWW.MODESIGNITALIA.IT](http://WWW.MODESIGNITALIA.IT)