



**modesign**

**LISTINO PREZZI / PRICE LIST**

**2024**

## ESSENZE, MANIGLIE E VETRI ESSENCES, HANDLES AND GLASSES

### NOCE CANALETTO | AMERICAN WALNUT

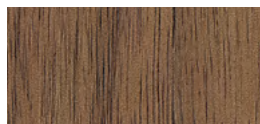

HAVANA

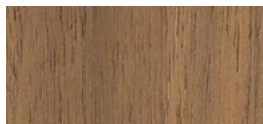

OLIO



ORIGINE



OLMO



GESSO



PANAMA

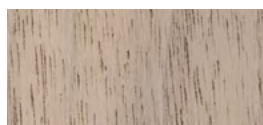

NATURA

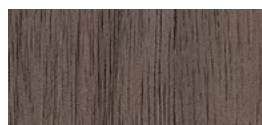

CIOCCOLATO

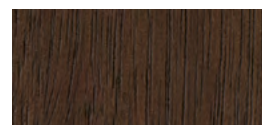

TORBA

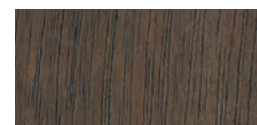

GRIGIO



ANTRACITE



BLU



ROSSO



GIALLO

### VETRI | GLASSES



TRASPARENTE



FUMÉ



CANNETÉ TRASPARENTE

### CERAMICHE 3D DA 1,2 CM. | FULL BODY CERAMIC 1,2 CM.



CALACATTA VECCHIA MACCHIA



KUROCA

### FINITURE METALLICHE | METAL FINISHES

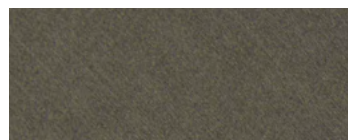

GRAFITE INCROCIATO

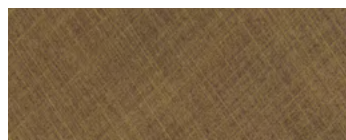

BRONZO INCROCIATO

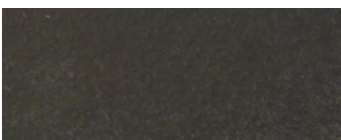

LAVA

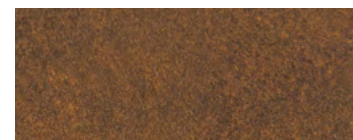

RAME

### MARMI | MARBLES - PER COLLEZIONE | FOR COLLECTION: DOMINO

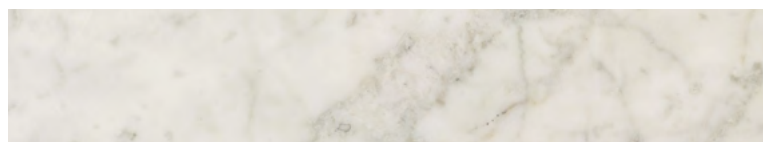

BIANCO CARRARA



EMPERADOR DARK

### MANIGLIE | HANDLES - PER COLLEZIONE | FOR COLLECTION: DOMINO



BRONZO

MANIGLIA GRANDE  
LARGE HANDLE 16.7X2  
MANIGLIA PICCOLA  
SMALL HANDLE 11.7X2



NICKEL

MANIGLIA GRANDE  
LARGE HANDLE 16.7X2  
MANIGLIA PICCOLA  
SMALL HANDLE 11.7X2



CANNA FUCILE

MANIGLIA GRANDE  
LARGE HANDLE 16.7X2  
MANIGLIA PICCOLA  
SMALL HANDLE 11.7X2

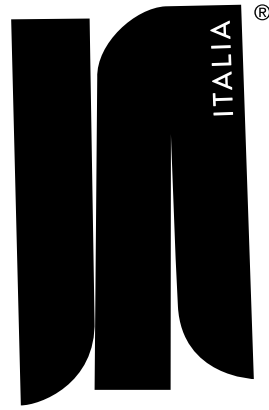

**modesign**



## 03 \_ GIORNO E NOTTE DAY AND NIGHT

107 \_ SISTEMA COMPONIBILE BOOK  
BOOK MODULAR SYSTEM

127 \_ SISTEMA COMPONIBILE DOMINO  
DOMINO MODULAR SYSTEM

179 \_ DIVANO COMPONIBILE PENTA  
PENTA MODULAR SOFA

04 GUIDA ALLE SPECIFICHE ORDINE  
GUIDE TO ORDER SPECIFICATIONS

05 CARATTERISTICHE TECNICHE  
TECHNICAL CHARACTERISTICS

40 CREDENZE, PORTA TV, VETRINE E MADIE  
SIDEBOARDS, TV UNITS, DISPLAY UNITS AND CUPBOARDS

46 TAVOLI E SEDIE  
TABLES AND CHAIRS

55 SPECCHIERE  
MIRRORS

57 TAVOLINI E CONSOLLE  
SMALL TABLES AND CONSOLLE

62 SCRIVANIE E POLTRONE  
DESKS AND ARMCHAIRS

64 COMODINI, COMÒ, CASSETTIERE  
BEDSIDE TABLES, CHEST OF DRAWERS, DRAWER UNITS

69 POLTRONA, POUF E PANCHETTE  
ARMCHAIR, POUF AND BENCHES

71 LETTI  
BEDS

102 ARMADI  
WARDROBES

106 BOISERIE  
WALL PANELS

# GUIDA ALLE SPECIFICHE ORDINE GUIDE TO ORDER SPECIFICATIONS

AL MOMENTO DELL'ORDINE SPECIFICARE SEMPRE LA FINITURA DELLA STRUTTURA E DEL FRONTALE ED EVENTUALI MULTICOLORE SU TESSUTI DI RIVESTIMENTO

WHEN ORDERING SPECIFY THE CARCASE AND FRONT FINISH AND MULTICOLOUR UPHOLSTERY FABRICS, IF APPLICABLE.

## ESEMPI PER IL CALCOLO PREZZO EXAMPLES FOR PRICE CALCULATION

### MULTICOLORE SU RIVESTIMENTO DOGHE MULTICOLOR ON SLAT COVER

STRUTTURA: FINITURA CANALETTO OLMO  
STRUCTURE: ELM CANALETTO FINISH

PANNELLO RIVESTITO CON DOGHE MULTICOLORE CAT. B  
PANEL COVERED WITH MULTICOLOR SLATS CAT. B

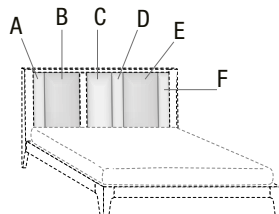
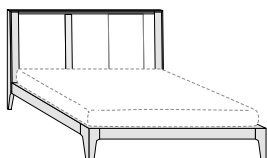

"A-C-E" FINITURA LINO BEIGE  
"B-D-F" FINITURA LINO JEANS  
"A-C-E" BEIGE LINEN FINISH  
"B-D-F" JEANS LINEN FINISH

NEL CASO DI FINITURE DIVERSE ANCHE SE DELLA STESSA CATEGORIA TESSUTO COME NELL'ESEMPIO (A,C,E LINO BEIGE E B,D,F LINO JEANS), IL PREZZO DEVE ESSERE MAGGIORATO AL +10% COME MULTICOLORE TENENDO IN CONSIDERAZIONE CHE, IN PRESENZA DI TESSUTI, SI DEVE FAR RIFERIMENTO ANCHE ALLA CATEGORIA TESSUTO SCELTA.

FOR DIFFERENT FINISHES, EVEN IF THEY ARE IN THE SAME FABRIC CATEGORY, AS IN THE EXAMPLE (A, C, E BEIGE LINEN AND B, D, F LINEN DENIM), ADD 10% TO THE PRICE AS MULTICOLOUR, AND WHEN FABRICS ARE INVOLVED REMEMBER TO INDICATE THE CHOSEN FABRIC CATEGORY.

	CAT. A ECOPELLE/ECONABUK FAUX LEATHER/ECONABUK	CAT. B LINO/VELLUTO LINEN/VELVET	CAT. C PELLE LEATHER
CANALETTO	2.573	2.709	3.224
Multicolor	+ 10 %		
	mc 0,25 – Kg 65		

### MULTICOLORE SU FRONTALE MULTICOLOR ON FRONT

STRUTTURA: CANALETTO ANTRACITE  
STRUCTURE: CANALETTO ANTHRACITE

FRONTALI: CANALETTO MULTICOLORE  
FRONTS: CANALETTO MULTICOLOR

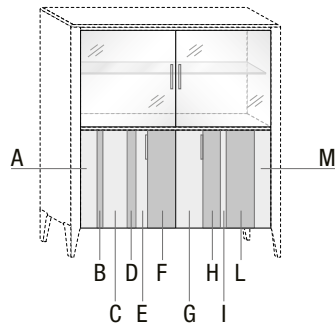
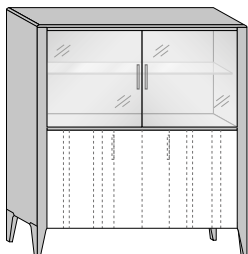

"A-C-E-G-I-M" CANALETTO ANTRACITE  
"B-D-F-H-L" CANALETTO GRIGIO  
"A-C-E-G-I-M" CANALETTO ANTHRACITE  
"B-D-F-H-L" CANALETTO GREY

NEL CASO DI FINITURE DIVERSE TRA FRONTALE E FRONTALE, IL PREZZO DEVE ESSERE MAGGIORATO AL +10% COME MULTICOLORE.

IF FRONT FINISHES ARE DIFFERENT FROM EACH OTHER, ADD 10% TO THE PRICE AS MULTICOLOUR.

CANALETTO	3.528
Multicolor	+ 10 %
	mc 1,13 – Kg 60

### MULTICOLORE SU FRONTALE MULTICOLOR ON FRONT

STRUTTURA: CANALETTO HAVANA  
STRUCTURE: CANALETTO HAVANA

FRONTALI: CANALETTO MULTICOLORE  
DOGA (Z): RIVESTITA CAT.A ECONABUK  
FRONTS: CANALETTO MULTICOLOR  
SLAT (Z): COVERED CAT.A ECONABUK

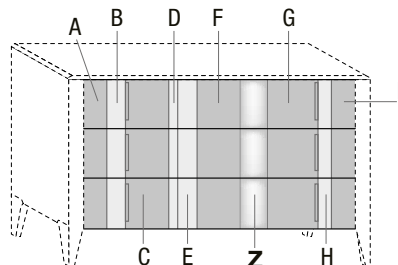
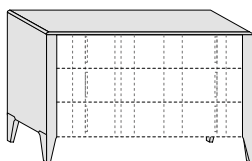

"A-C-F-G-I" CANALETTO OLMO  
"B-D-E-H" CANALETTO BLU  
"A-C-F-G-I" CANALETTO ELM  
"B-D-E-H" CANALETTO BLUE

NEL CASO DI FINITURA FRONTALI DIVERSA DALLA FINITURA STRUTTURA, IL PREZZO DEVE ESSERE MAGGIORATO AL +10% COME MULTICOLORE TENENDO IN CONSIDERAZIONE CHE, IN PRESENZA DI TESSUTI, SI DEVE FAR RIFERIMENTO ANCHE ALLA CATEGORIA TESSUTO SCELTA.

IF FRONT FINISH IS DIFFERENT FROM THE STRUCTURE FINISH, ADD 10% TO THE PRICE AS MULTICOLOUR AND WHEN FABRICS ARE INVOLVED REMEMBER TO INDICATE THE CHOSEN FABRIC CATEGORY.

	CAT. A ECOPELLE/ECONABUK FAUX LEATHER/ECONABUK	CAT. B LINO/VELLUTO LINEN/VELVET	CAT. C PELLE LEATHER
CANALETTO	2.231		
Multicolor	+ 10 %		
	mc 0,69 – Kg 70		

**CREDENZE E PORTA TV**  
**SIDEBOARDS AND TV UNIT**

**CREDENZA 3 ANTE**  
**SIDEBOARD WITH 3 DOORS**

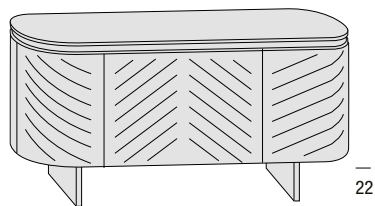

**CREDENZA 4 ANTE**  
**SIDEBOARD WITH 4 DOORS**

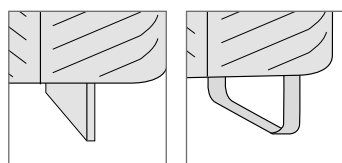
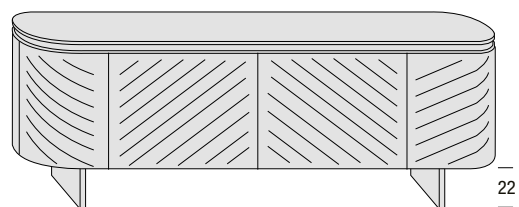

PIEDE VETRO  
GLASS FEET

PIEDE METALLO  
METAL FEET

OPERA

**CREDENZA 3 E 4 ANTE**

- STRUTTURA:** PANNELLO IN MDF IMPIALLACCIATO NOCE CANALETTO
- TOP:** LEGNO SP 1 CM , PANNELLO DI MULTISTRATO DI NOCE CANALETTO
- ANTE LEGNO:** MULTISTRATO DI LEGNO IMPIALLACCIATO NOCE CANALETTO SP.2.6 CM
- MANIGLIA:** MANIGLIA A GOLA IN LEGNO
- RIPIANI:** VETRO
- OPTIONAL PIANI:** CERAMICA 3D SP. 1,2 CM
- GAMBE:** VETRO TRASPARENTE TEMPERATO O METALLO VERNICIATO

**SIDEBOARD WITH 3 AND 4 DOORS**

- STRUCTURE:** CANALETTO WALNUT VENEERED MDF PANEL
- TOP:** 1 CM THICK WOOD, CANALETTO WALNUT MULTILAYER PANEL
- WOODEN DOORS:** CANALETTO WALNUT VENEERED MULTILAYER WOOD THICKNESS 2.6 CM
- HANDLE:** WOODEN GROOVE HANDLE
- SHELVES:** GLASS
- TOP OPTIONAL:** FULL BODY CERAMIC H. 1,2 CM
- LEGS:** TEMPERED TRANSPARENT GLASS OR PAINTED METAL

**CREDENZA 3 ANTE**  
**SIDEBOARD WITH 3 DOORS**

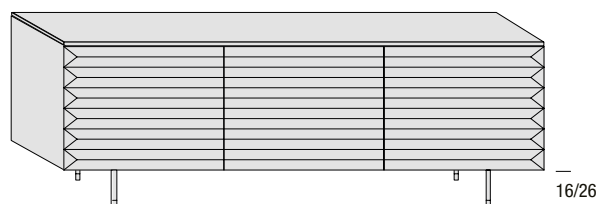

YORK

**CREDENZA 3 ANTE**

- STRUTTURA:** PANNELLO DI LISTELLARE DI NOCE CANALETTO
- ANTE LEGNO:** PANNELLO IN MDF IMPIALLACCIATO NOCE CANALETTO
- MANIGLIA:** MANIGLIA A GOLA IN LEGNO
- OPTIONAL PIANI:** CERAMICA 3D SP. 1,2 CM
- NELLA VERSIONE FINITURA METALLO LA STRUTTURA CAMBIA IN PANNELLO DI MDF VERNICIATO EFFETTO METALLO

**SIDEBOARD WITH 3 DOORS**

- STRUCTURE:** CANALETTO WALNUT BLOCKBOARD PANEL
- WOODEN DOORS:** CANALETTO WALNUT MULTILAYER PANEL
- OPENING:** WOODEN GROOVE HANDLE
- TOP OPTIONAL:** FULL BODY CERAMIC H. 1,2 CM
- IN THE METAL LACQUERED FINISH VERSION THE STRUCTURE CHANGES TO METAL EFFECT PAINTED MDF PANEL

### CREDENZE E PORTA TV SIDEBOARDS AND TV UNIT

#### CREDENZA 3 ANTE SIDEBOARD WITH 3 DOORS

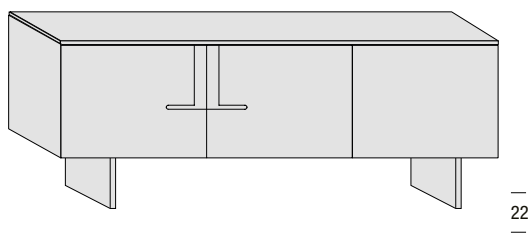

#### CREDENZA 4 ANTE SIDEBOARD WITH 4 DOORS

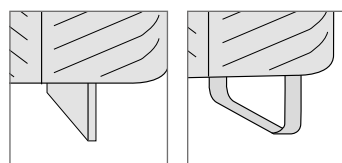
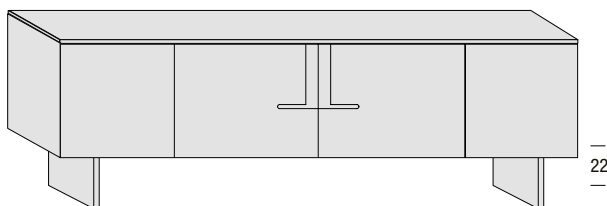

PIEDE VETRO  
GLASS FEET

PIEDE METALLO  
METAL FEET

BOOK

#### CREDENZA 3 E 4 ANTE

<b>STRUTTURA:</b>	PANNELLO DI LISTELLARE DI NOCE CANALETTO
<b>ANTE LEGNO:</b>	PANNELLO IN MDF IMPIALLACCIATO NOCE CANALETTO
<b>MANIGLIA:</b>	PUSH PULL SU ANTA LISCIA E MANIGLIA IN MULTISTRATO IMPIALLACCIATO NOCE CANALETTO SU ALTRE ANTE
<b>OPTIONAL PIANI:</b>	CERAMICA 3D SP. 1,2 CM
<b>GAMBE:</b>	VETRO TRASPARENTE TEMPERATO O METALLO VERNICIATO

#### SIDEBOARD WITH 3 AND 4 DOORS

<b>STRUCTURE:</b>	CANALETTO WALNUT BLOCKBOARD PANEL
<b>WOODEN DOORS:</b>	CANALETTO WALNUT MULTILAYER PANEL
<b>OPENING:</b>	PUSH PULL ON SMOOTH DOOR AND CANALETTO WALNUT VENEERED MULTILAYER HANDLE ON OTHER DOORS
<b>TOP OPTIONAL:</b>	FULL BODY CERAMIC H. 1,2 CM
<b>LEGS:</b>	TEMPERED TRANSPARENT GLASS OR PAINTED METAL

#### CREDENZA 2 ANTE SIDEBOARD WITH 2 DOORS

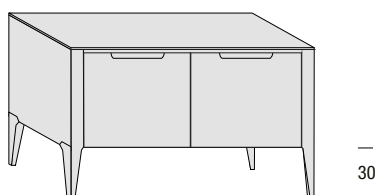

#### CREDENZA 3 ANTE SIDEBOARD WITH 3 DOORS

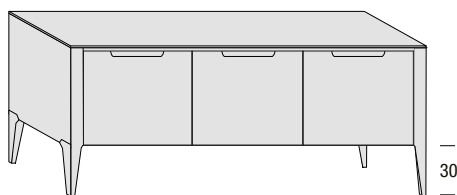

CANNAREGGIO

#### CREDENZA 2 E 3 ANTE

<b>STRUTTURA:</b>	PANNELLO DI LISTELLARE ESTERNO RIVESTITO IN NOCE CANALETTO E INTERNO RIVESTITO IN NOCE TANGANICA
<b>TOP:</b>	PANNELLO DI LISTELLARE RIVESTITO E BORDATO IN NOCE CANALETTO SP. 1.8
<b>ANTE LEGNO:</b>	PANNELLO DI LISTELLARE RIVESTITO E BORDATO IN NOCE CANALETTO SP. CM 1.8 LISTELLI ORIZZONTALI IN MASSELLO DI NOCE CANALETTO.
<b>SPALLE:</b>	LEGNO FJ RIVESTITO NOCE CANALETTO SEZIONE 60/70X25
<b>PIEDI POSTERIORI:</b>	MASSELLO DI NOCE CANALETTO
<b>SCHIENALI:</b>	PANNELLO DI MULTISTRATO NOCE TANGANICA
<b>MANIGLIA:</b>	IN METALLO VERNICIATO METAL GREY
<b>RIPIANI:</b>	VETRO
<b>OPTIONAL PIANI:</b>	CERAMICA 3D SP. 1,2 CM

#### SIDEBOARD WITH 2, 3 DOORS AND TV UNIT

<b>STRUCTURE:</b>	BLOCKBOARD PANEL: OUTSIDE COVERED IN CANALETTO WALNUT, INSIDE COVERED IN TANGANICA WALNUT
<b>TOP:</b>	STRIP PANEL COATED AND EDGED IN CANALETTO WALNUT SP. CM 1.8
<b>WOODEN DOORS:</b>	STRIP PANEL COVERED AND EDGED IN CANALETTO WALNUT SP. CM 1.8 HORIZONTAL STRIPS IN SOLID CANALETTO WALNUT.
<b>SUPPORT PANELS:</b>	FJ WOOD COVERED IN CANALETTO WALNUT 60/70X25 SECTION
<b>BACK FEET:</b>	SOLID CANALETTO WALNUT
<b>BACK PANELS:</b>	MULTILAYER PANEL IN TANGANICA WALNUT
<b>HANDLE:</b>	METAL HANDLE PAINTED METAL GREY
<b>SHELVES:</b>	GLASS
<b>TOP OPTIONAL:</b>	FULL BODY CERAMIC H. 1,2 CM



CARATTERISTICHE TECNICHE  
TECHNICAL CHARACTERISTICS

CREDENZE E PORTA TV  
SIDEBOARDS AND TV UNIT

CREDENZA 2 E 3 ANTE  
SIDEBOARD WITH 2 AND 3 DOORS

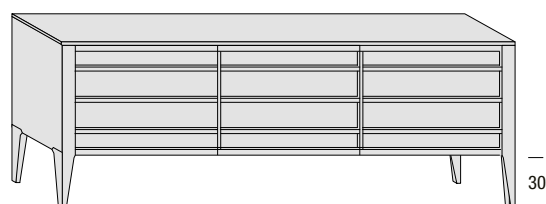

PORTA TV  
TV UNIT

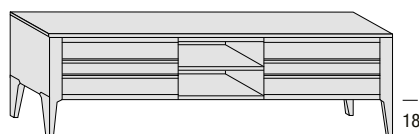

SHANGHAI

CREDENZA 2, 3 ANTE E PORTA TV

<b>STRUTTURA:</b>	PANNELLO DI LISTELLARE ESTERNO RIVESTITO IN NOCE CANALETTO E INTERNO RIVESTITO IN NOCE TANGANICA
<b>TOP:</b>	PANNELLO DI LISTELLARE RIVESTITO E BORDATO IN NOCE CANALETTO SP. 1.8
<b>ANTE LEGNO:</b>	PANNELLO DI LISTELLARE RIVESTITO E BORDATO IN NOCE CANALETTO SP. CM 1,8 LISTELLI ORIZZONTALI IN MASSELLO DI NOCE CANALETTO.
<b>SPALLE:</b>	LEGNO FJ RIVESTITO NOCE CANALETTO SEZIONE 60/70X25
<b>PIEDI POSTERIORI:</b>	MASSELLO DI NOCE CANALETTO
<b>SCHIENALI:</b>	PANNELLO DI MULTISTRATO NOCE TANGANICA
<b>MANIGLIA:</b>	IN MASSELLO DI NOCE CANALETTO INTEGRATA NEL FRONTALE
<b>RIPIANI:</b>	VETRO
<b>OPTIONAL PIANI:</b>	CERAMICA SP. 1,2 CM

SIDEBOARD WITH 2, 3 DOORS AND TV UNIT

<b>STRUCTURE:</b>	BLOCKBOARD PANEL: OUTSIDE COVERED IN CANALETTO WALNUT, INSIDE COVERED IN TANGANICA WALNUT
<b>TOP:</b>	STRIP PANEL COATED AND EDGED IN CANALETTO WALNUT SP. CM 1.8
<b>WOODEN DOORS:</b>	STRIP PANEL COVERED AND EDGED IN CANALETTO WALNUT SP. CM 1.8 HORIZONTAL STRIPS IN SOLID CANALETTO WALNUT.
<b>SUPPORT PANELS:</b>	FJ WOOD COVERED IN CANALETTO WALNUT 60/70X25 SECTION
<b>BACK FEET:</b>	SOLID CANALETTO WALNUT
<b>BACK PANELS:</b>	MULTILAYER PANEL IN TANGANICA WALNUT
<b>HANDLE:</b>	SOLID CANALETTO WALNUT HANDLE INTEGRATED IN THE FRONT
<b>SHELVES:</b>	GLASS
<b>TOP OPTIONAL:</b>	CERAMIC TH. 1,2 CM

CREDENZA 2 E 3 ANTE  
SIDEBOARD WITH 2 AND 3 DOORS

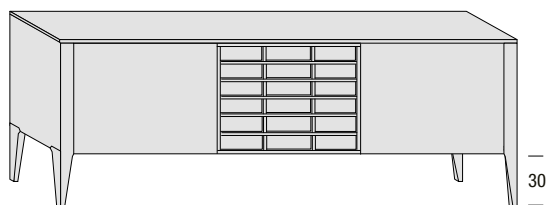
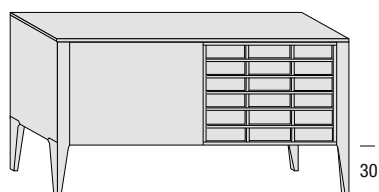

SINGAPORE

CREDENZA 2 E 3 ANTE

<b>STRUTTURA:</b>	PANNELLO DI LISTELLARE ESTERNO RIVESTITO IN NOCE CANALETTO E INTERNO RIVESTITO IN NOCE TANGANICA
<b>TOP:</b>	PANNELLO DI LISTELLARE RIVESTITO E BORDATO IN NOCE CANALETTO SP. 1.8
<b>ANTE LEGNO:</b>	PANNELLO DI LISTELLARE RIVESTITE E BORDATE IN NOCE CANALETTO SP. CM 1,8 LISTELLI ORIZZONTALI IN MASSELLO DI NOCE CANALETTO.
<b>SPALLE:</b>	LEGNO FJ RIVESTITO NOCE CANALETTO SEZIONE 60/70X25
<b>PIEDI POSTERIORI:</b>	MASSELLO DI NOCE CANALETTO
<b>SCHIENALI:</b>	PANNELLO DI MULTISTRATO NOCE TANGANICA
<b>APERTURE:</b>	MANIGLIA IN MASSELLO DI NOCE CANALETTO INTEGRATA SU ANTA DECORATA E PUSH-PULL SU ANTA LISCIA
<b>RIPIANI:</b>	VETRO
<b>OPTIONAL PIANI:</b>	CERAMICA SP. 1,2 CM

SIDEBOARD WITH 2 AND 3 DOORS

<b>STRUCTURE:</b>	BLOCKBOARD PANEL: OUTSIDE COVERED IN CANALETTO WALNUT, INSIDE COVERED IN TANGANICA WALNUT
<b>TOP:</b>	PANNELLO DI LISTELLARE RIVESTITO E BORDATO IN NOCE CANALETTO SP. CM 1.8
<b>WOODEN DOORS:</b>	STRIP PANEL COVERED AND EDGED IN CANALETTO WALNUT SP. CM 1.8 HORIZONTAL STRIPS IN SOLID CANALETTO WALNUT.
<b>SUPPORT PANELS:</b>	FJ WOOD COVERED IN CANALETTO WALNUT 60/70X25 SECTION
<b>BACK FEET:</b>	SOLID CANALETTO WALNUT
<b>BACK PANELS:</b>	MULTILAYER PANEL IN TANGANICA WALNUT
<b>OPENING:</b>	SOLID CANALETTO WALNUT HANDLE INTEGRATED ON DECORATED DOOR AND PUSH-PULL ON SMOOTH DOOR
<b>SHELVES:</b>	GLASS
<b>TOP OPTIONAL:</b>	CERAMIC TH. 1,2 CM

### CREDENZE E PORTA TV SIDEBOARDS AND TV UNIT

#### CREDENZA 2 E 3 ANTE SIDEBOARD WITH 2 AND 3 DOORS

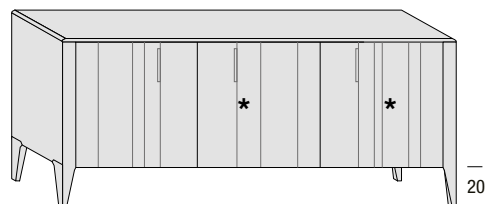
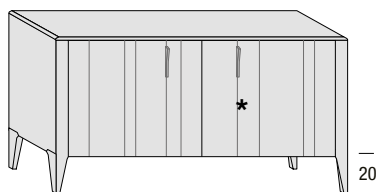

#### PORTA TV 2 ANTE LEGNO E VANO A GIORNO TV UNIT WITH 2 WOODEN DOORS AND OPEN COMPARTMENT

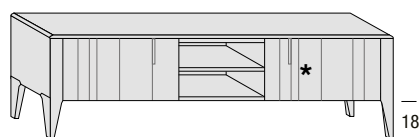

DOMINO



\* DOGA LEGNO LISCIA  
PLAIN WOODEN SLAT



\* DOGA RIGHE  
STRIPED SLAT



\* DOGA QUADRO LEGNO  
WOODEN SQUARE SLAT

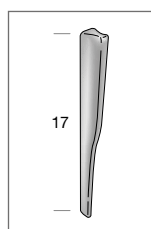

MANIGLIA GRANDE  
LARGE HANDLE

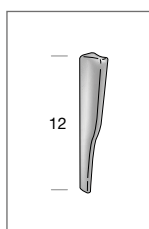

MANIGLIA PICCOLA  
SMALL HANDLE

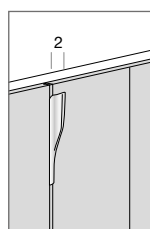

INCASTRO MANIGLIA  
HANDLE JOINT

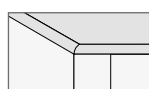

DETTAGLIO TOP SAGOMATO  
SHAPED TOP DETAIL

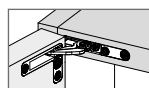

CERNIERA AIR  
AIR HINGE

#### CREDENZA 2 E 3 ANTE

<b>STRUTTURA:</b>	PANNELLO DI LISTELLARE ESTERNO RIVESTITO IN NOCE CANALETTO E INTERNO RIVESTITO IN NOCE TANGANICA
<b>TOP:</b>	PANNELLO DI LISTELLARE RIVESTITO NOCE CANALETTO E STRUTTURA PERIMETRALE IN MASSELLO DI NOCE CANALETTO, SP. 1.8
<b>ANTE LEGNO:</b>	PANNELLO DI LISTELLARE RIVESTITE INTERNAMENTE IN NOCE CANALETTO ED ESTERNAMENTE IN NOCE TANGANICA SP. 2.9 CM – CON DOGE IN MULTISTRATI RIVESTITTE NOCE CANALETTO E LATI IN MASSELLO DI NOCE CANALETTO SP. 0.3 CM – RIPIANI INTERNI VETRO
<b>SPALLE:</b>	LEGNO FJ RIVESTITO NOCE CANALETTO SEZIONE 60/70X25
<b>PIEDI POSTERIORI:</b>	MASSELLO DI NOCE CANALETTO
<b>SCHIENALI:</b>	PANNELLO DI MULTISTRATO NOCE TANGANICA
<b>MANIGLIA:</b>	MANIGLIA DOMINO SU DISEGNO

#### SIDEBOARD WITH 2 AND 3 DOORS

<b>STRUCTURE:</b>	BLOCKBOARD PANEL: OUTSIDE COVERED IN CANALETTO WALNUT, INSIDE COVERED IN TANGANICA WALNUT
<b>TOP:</b>	BLOCKBOARD PANEL COVERED IN CANALETTO WALNUT AND PERIMETRIC STRUCTURE IN SOLID CANALETTO WALNUT, TH. 1.8
<b>WOODEN DOORS:</b>	BLOCKBOARD PANEL COVERED INSIDE IN CANALETTO WALNUT AND OUTSIDE IN TANGANICA WALNUT TH. 2.9 CM – WITH MULTILAYER SLAT COVERED IN CANALETTO WALNUT AND SIDES IN SOLID CANALETTO WALNUT TH. 0.3 CM – INSIDE GLASS SHELVES
<b>SUPPORT PANELS:</b>	FJ WOOD COVERED IN CANALETTO WALNUT 60/70X25 SECTION
<b>BACK FEET:</b>	SOLID CANALETTO WALNUT
<b>BACK PANELS:</b>	MULTILAYER PANEL IN TANGANICA WALNUT
<b>HANDLE:</b>	DOMINO HANDLE AS IN THE DRAWING

#### PORTA TV 2 ANTE E VANO A GIORNO

<b>STRUTTURA:</b>	PANNELLO DI LISTELLARE ESTERNO RIVESTITO IN NOCE CANALETTO E INTERNO RIVESTITO IN NOCE TANGANICA
<b>TOP:</b>	PANNELLO DI LISTELLARE RIVESTITO NOCE CANALETTO E STRUTTURA PERIMETRALE IN MASSELLO DI NOCE CANALETTO, SP. 1.8
<b>ANTE LEGNO:</b>	PANNELLO DI LISTELLARE RIVESTITE INTERNAMENTE IN NOCE CANALETTO ED ESTERNAMENTE IN NOCE TANGANICA SP. 2.9 CM – CON DOGE IN MULTISTRATI RIVESTITTE NOCE CANALETTO E LATI IN MASSELLO DI NOCE CANALETTO SP. 0.3 CM – RIPIANI INTERNI VETRO
<b>SPALLE:</b>	LEGNO FJ RIVESTITO NOCE CANALETTO SEZIONE 60/70X25
<b>PIEDI POSTERIORI:</b>	MASSELLO DI NOCE CANALETTO
<b>SCHIENALI:</b>	PANNELLO DI MULTISTRATO NOCE CANALETTO
<b>MANIGLIA:</b>	MANIGLIA DOMINO SU DISEGNO

#### TV UNIT WITH 2 DOORS AND OPEN COMPARTMENT

<b>STRUCTURE:</b>	BLOCKBOARD PANEL: OUTSIDE COVERED IN CANALETTO WALNUT, INSIDE COVERED IN TANGANICA WALNUT
<b>TOP:</b>	BLOCKBOARD PANEL COVERED IN CANALETTO WALNUT AND PERIMETRIC STRUCTURE IN SOLID CANALETTO WALNUT, TH. 1.8
<b>WOODEN DOORS:</b>	BLOCKBOARD PANEL COVERED INSIDE IN CANALETTO WALNUT AND OUTSIDE IN TANGANICA WALNUT TH. 2.9 CM – WITH MULTILAYER SLAT COVERED IN CANALETTO WALNUT AND SIDES IN SOLID CANALETTO WALNUT TH. 0.3 CM – INSIDE GLASS SHELVES
<b>SUPPORT PANELS:</b>	FJ WOOD COVERED IN CANALETTO WALNUT 60/70X25 SECTION
<b>BACK FEET:</b>	SOLID CANALETTO WALNUT
<b>BACK PANELS:</b>	MULTILAYER PANEL IN CANALETTO WALNUT
<b>HANDLE:</b>	DOMINO HANDLE AS IN THE DRAWING

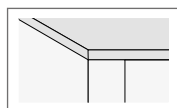
**CARATTERISTICHE TECNICHE**  
**TECHNICAL CHARACTERISTICS**
**MADIE E VETRINE**  
**DISPLAY UNITS**
**MADIA 2 ANTE LEGNO**  
**DISPLAY UNIT WITH 2 WOODEN DOORS**

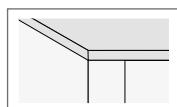
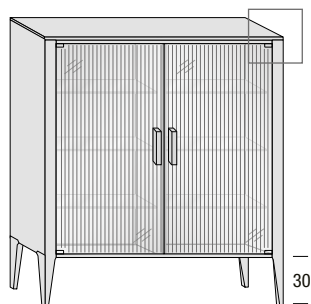
**DETTAGLIO TOP DRITTO**  
 STRAIGHT TOP DETAIL

**VETRINA 2 ANTE VETRO**  
**DISPLAY UNIT WITH 2 GLASS DOORS**

**DETTAGLIO TOP DRITTO**  
 STRAIGHT TOP DETAIL

**MADIA 2 ANTE**

<b>STRUTTURA:</b>	PANNELLO DI LISTELLARE ESTERNO RIVESTITO IN NOCE CANALETTO E INTERNO RIVESTITO IN NOCE TANGANICA
<b>TOP:</b>	PANNELLO DI LISTELLARE RIVESTITO E BORDATO IN NOCE CANALETTO SP. 1.8
<b>ANTE LEGNO:</b>	PANNELLO DI LISTELLARE RIVESTITE E BORDATE IN NOCE CANALETTO SP. CM 1,8 LISTELLI ORIZZONTALI IN MASSELLO DI NOCE CANALETTO.
<b>SPALLE:</b>	LEGNO FJ RIVESTITO NOCE CANALETTO SEZIONE 60/70X25
<b>PIEDI POSTERIORI:</b>	MASSELLO DI NOCE CANALETTO
<b>SCHIENALI:</b>	PANNELLO DI MULTISTRATO NOCE TANGANICA
<b>MANIGLIA:</b>	IN MASSELLO DI NOCE CANALETTO INTEGRATA NEL FRONTALE
<b>RIPIANI:</b>	VETRO

**DISPLAY UNIT 2 DOORS**

<b>STRUCTURE:</b>	BLOCKBOARD PANEL: OUTSIDE COVERED IN CANALETTO WALNUT, INSIDE COVERED IN TANGANICA WALNUT
<b>TOP:</b>	STRIP PANEL COATED AND EDGED IN CANALETTO WALNUT SP. CM 1.8
<b>WOODEN DOORS:</b>	STRIP PANEL COVERED AND EDGED IN CANALETTO WALNUT SP. CM 1.8 HORIZONTAL STRIPS IN SOLID CANALETTO WALNUT.
<b>SUPPORT PANELS:</b>	FJ WOOD COVERED IN CANALETTO WALNUT 60/70X25 SECTION
<b>BACK FEET:</b>	SOLID CANALETTO WALNUT
<b>BACK PANELS:</b>	MULTILAYER PANEL IN TANGANICA WALNUT
<b>OPENING:</b>	SOLID CANALETTO WALNUT HANDLE INTEGRATED IN THE FRONT
<b>SHELVES:</b>	GLASS

**VETRINA 2 ANTE**

<b>STRUTTURA:</b>	PANNELLO DI LISTELLARE ESTERNO RIVESTITO IN NOCE CANALETTO E INTERNO RIVESTITO IN NOCE TANGANICA
<b>TOP:</b>	PANNELLO DI LISTELLARE RIVESTITO E BORDATO IN NOCE CANALETTO SP. 1.8
<b>ANTE VETRO:</b>	VETRO CANNETÉ TRASPARENTE TEMPERATO SP CM 0,6
<b>SPALLE:</b>	LEGNO FJ RIVESTITO NOCE CANALETTO SEZIONE 60/70X25
<b>PIEDI POSTERIORI:</b>	MASSELLO DI NOCE CANALETTO
<b>SCHIENALE:</b>	SCHIENALE IN MULTISTRATI IMPIALLACCIATO NOCE CANALETTO
<b>MANIGLIA:</b>	IN MASSELLO DI NOCE CANALETTO SU DISEGNO
<b>RIPIANI:</b>	VETRO
<b>OPTIONAL:</b>	STRISCIA LED SUL TOP

**DISPLAY UNIT 2 DOORS**

<b>STRUCTURE:</b>	BLOCKBOARD PANEL: OUTSIDE COVERED IN CANALETTO WALNUT, INSIDE COVERED IN TANGANICA WALNUT
<b>TOP:</b>	STRIP PANEL COATED AND EDGED IN CANALETTO WALNUT SP. CM 1.8
<b>GLASS DOORS:</b>	TRANSPARENT TEMPERED CANNETÉ GLASS, 0.6 CM TH
<b>SUPPORT PANELS:</b>	FJ WOOD COVERED IN CANALETTO WALNUT 60/70X25 SECTION
<b>BACK FEET:</b>	SOLID CANALETTO WALNUT
<b>BACK PANEL:</b>	BACK PANEL IN MULTILAYER CANALETTO WALNUT
<b>HANDLE:</b>	SOLID CANALETTO WALNUT HANDLE ON DRAWING
<b>SHELVES:</b>	GLASS
<b>OPTIONAL:</b>	LED STRIP ON THE TOP

**VETRINA 2 E 3 ANTE**

<b>STRUTTURA:</b>	PANNELLO DI LISTELLARE DI NOCE CANALETTO
<b>ANTE:</b>	PROFILO IN MASSELLO DI NOCE CANALETTO E PARTI IN METALLO VERNICIATO METAL GRAY
<b>PIEDI:</b>	CILINDRO IN METALLO VERNICIATO E PUNTALE IN LEGNO MASSELLO DI NOCE CANALETTO
<b>MANIGLIA:</b>	MANIGLIA INTEGRATA IN LEGNO MASSELLO DI NOCE CANALETTO
<b>RIPIANI:</b>	2 RIPIANI IN VETRO
<b>OPTIONAL:</b>	STRISCE LED SUI FIANCHI

**DISPLAY UNIT WITH 2 AND 3 DOORS**

<b>STRUCTURE:</b>	CANALETTO WALNUT BLOCKBOARD PANEL
<b>DOORS:</b>	PROFILE IN SOLID CANALETTO WALNUT AND PARTS IN METAL GREY PAINTED
<b>FEET:</b>	PAINTED METAL CYLINDER AND SOLID CANALETTO WALNUT WOOD TIP
<b>HANDLE:</b>	INTEGRATED HANDLE IN SOLID CANALETTO WALNUT
<b>SHELVES:</b>	2 GLASS SHELVES
<b>OPTIONAL:</b>	LED STRIPES ON THE SIDES

SHANGHAI

YORK

### VETRINE DISPLAY UNITS

#### VETRINA 2 ANTE LEGNO E 2 ANTE VETRO DISPLAY UNIT WITH 2 WOODEN DOORS AND 2 GLASS DOORS

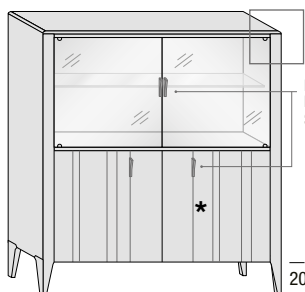

MANIGLIA DOMINO  
PICCOLA  
SMALL DOMINO HANDLE

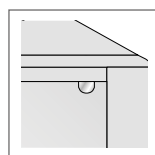

CERNIERA CHIUSURA  
ACCOMPAGNATA  
SOFT CLOSE HINGE



\* DOGA LEGNO LISCIA  
PLAIN WOODEN SLAT



\* DOGA RIGHE  
STRIPED SLAT



\* DOGA QUADRO LEGNO  
WOODEN SQUARE SLAT

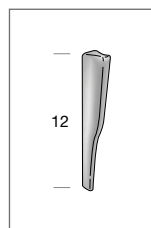

MANIGLIA PICCOLA  
SMALL HANDLE

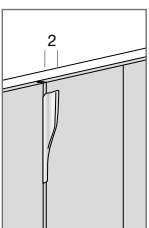

INCASTRO MANIGLIA  
HANDLE JOINT

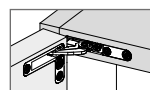

CERNIERA AIR  
AIR HINGE

#### VETRINA 2 ANTE VETRO DISPLAY UNIT WITH 2 GLASS DOORS

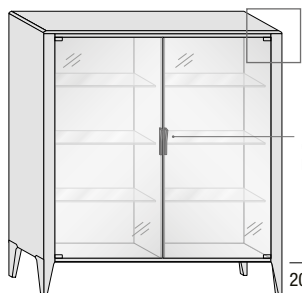

MANIGLIA DOMINO  
GRANDE  
LARGE DOMINO HANDLE

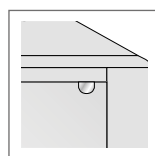

CERNIERA CHIUSURA  
ACCOMPAGNATA  
SOFT CLOSE HINGE

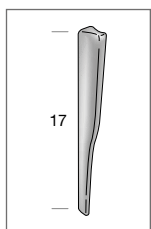

MANIGLIA GRANDE  
LARGE HANDLE

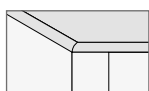

DETTAGLIO TOP SAGOMATO  
SHAPED TOP DETAIL

#### VETRINA 2 ANTE LEGNO E 2 ANTE VETRO

<b>STRUTTURA:</b>	PANNELLO DI LISTELLARE ESTERNO RIVESTITO IN NOCE CANALETTO, INTERNO ANTE LEGNO RIVESTITO IN NOCE TANGANICA, INTERNO ANTE VETRO RIVESTITO IN NOCE CANALETTO
<b>TOP:</b>	PANNELLO DI LISTELLARE IMPIALLACCIATO NOCE CANALETTO E STRUTTURA PERIMETRALE IN MASSELLO DI NOCE CANALETTO, SP. 1.8
<b>ANTE LEGNO:</b>	PANNELLO DI LISTELLARE IMPIALLACCIATA INTERNAMENTE IN NOCE CANALETTO ED ESTERNAMENTE IN NOCE TANGANICA SP. 2.9 CM - CON DOGE IN MULTISTRATI IMPIALLACCIATO NOCE CANALETTO E LATI IN MASSELLO DI NOCE CANALETTO SP. 0.3 CM
<b>ANTE VETRO:</b>	VETRO TEMPERATO S.P 0.6 CM - RIPIANI INTERNI VETRO
<b>SPALLE:</b>	LEGNO FJ RIVESTITO NOCE CANALETTO SEZIONE 60/70X25
<b>PIEDI POSTERIORI:</b>	MASSELLO DI NOCE CANALETTO
<b>SCHIENALI:</b>	SCHIENALE INTERNO ANTE LEGNO IN MULTISTRATO NOCE TANGANICA SCHIENALE INTERNO ANTE VETRO IN MULTISTRATI DI NOCE CANALETTO
<b>APERTURA:</b>	MANIGLIA DOMINO SU DISEGNO IN ZAMA VERNICIATO

#### DISPLAY UNIT WITH 2 WOODEN DOORS AND 2 GLASS DOORS

<b>STRUCTURE:</b>	BLOCKBOARD PANEL: OUTSIDE COVERED IN CANALETTO WALNUT, INSIDE OF WOODEN DOOR COVERED IN TANGANICA WALNUT, INSIDE OF GLASS DOORS COVERED IN CANALETTO WALNUT
<b>TOP:</b>	BLOCKBOARD PANEL VENEERED IN CANALETTO WALNUT AND PERIMETRIC STRUCTURE IN SOLID CANALETTO WALNUT, TH. 1.8
<b>WOODEN DOORS:</b>	BLOCKBOARD PANEL: INSIDE VENEERED IN CANALETTO WALNUT AND OUTSIDE IN TANGANICA WALNUT TH. 2.9 CM - WITH MULTILAYER SLAT VENEERED IN CANALETTO WALNUT AND SIDES IN SOLID CANALETTO WOOD TH 0.3 CM
<b>GLASS DOORS:</b>	TEMPREDE GLASS TH. 0.6 CM - INTERNAL GLASS SHELVES
<b>SUPPORT PANELS:</b>	FJ WOOD COVERED IN CANALETTO WALNUT 60/70X25 SECTION
<b>BACK FEET:</b>	SOLID CANALETTO WALNUT
<b>BACK PANELS:</b>	BACK PANEL INSIDE WOODEN DOOR IN MULTILAYER TANGANICA WALNUT BACK PANEL INSIDE GLASS DOORS IN MULTILAYER CANALETTO WALNUT
<b>OPENING:</b>	DOMINO HANDLE IN METAL PAINTED ZAMAK

#### VETRINA 2 ANTE VETRO

<b>STRUTTURA:</b>	PANNELLO DI LISTELLARE RIVESTITO IN NOCE CANALETTO
<b>TOP:</b>	PANNELLO DI LISTELLARE IMPIALLACCIATO NOCE CANALETTO E STRUTTURA PERIMETRALE IN MASSELLO DI NOCE CANALETTO SP. 1.8
<b>ANTE VETRO:</b>	VETRO TEMPERATO S.P 0.6 CM - RIPIANI INTERNI VETRO
<b>SPALLE:</b>	LEGNO FJ RIVESTITO NOCE CANALETTO SEZIONE 60/70X25
<b>PIEDI POSTERIORI:</b>	MASSELLO DI NOCE CANALETTO
<b>SCHIENALI:</b>	SCHIENALE IN MULTISTRATI DI NOCE CANALETTO
<b>APERTURA:</b>	MANIGLIA DOMINO SU DISEGNO IN ZAMA VERNICIATO METALLO

#### DISPLAY UNIT WITH 2 GLASS DOORS

<b>STRUCTURE:</b>	BLOCKBOARD PANEL COVERED IN CANALETTO WALNUT
<b>TOP:</b>	BLOCKBOARD PANEL VENEERED IN CANALETTO WALNUT AND PERIMETRIC STRUCTURE IN SOLID CANALETTO WALNUT, TH. 1.8
<b>GLASS DOORS:</b>	TEMPREDE GLASS TH. 0.6 CM - INTERNAL GLASS SHELVES
<b>SUPPORT PANELS:</b>	FJ WOOD COVERED IN CANALETTO WALNUT 60/70X25 SECTION
<b>BACK FEET:</b>	SOLID CANALETTO WALNUT
<b>BACK PANELS:</b>	BACK PANEL IN MULTILAYER CANALETTO WALNUT
<b>OPENING:</b>	DOMINO HANDLE IN METAL PAINTED ZAMAK

CARATTERISTICHE TECNICHE  
TECHNICAL CHARACTERISTICS

**TAVOLO HOLE**  
HOLE TABLE

**PIANO IN LEGNO**  
WOODEN TOP

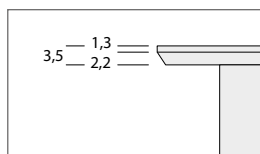
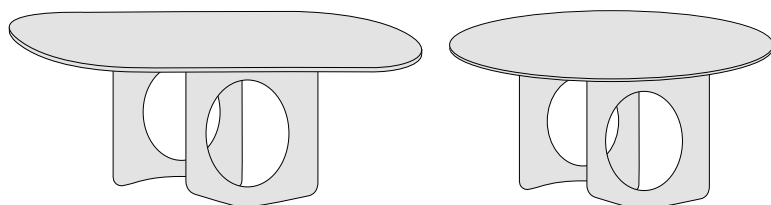

**PROFILO PIANO LEGNO**  
WOODEN TOP PROFILE

**PIANO IN LEGNO SPINATO**  
HERRINGBONE WOODEN TOP

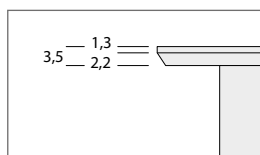
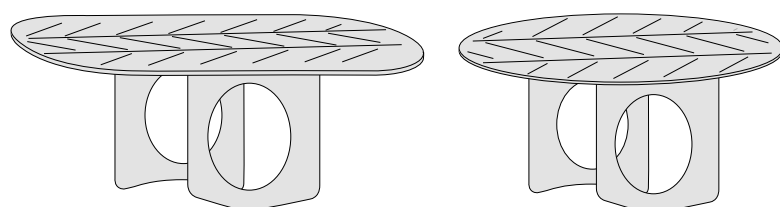

**PROFILO PIANO LEGNO**  
WOODEN TOP PROFILE

**PIANO IN CERAMICA**  
CERAMIC TOP

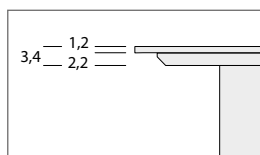
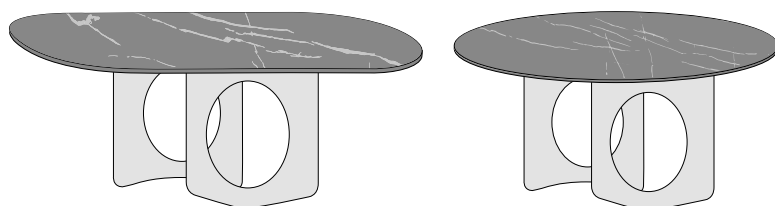

**PROFILO PIANO CERAMICA**  
CERAMIC TOP PROFILE

**TAVOLO LEGNO**

**TOP:** TOP SUPERIORE IN PANNELLO DI MDF IMPIALLACCIATO IN NOCE CANALETTO SP.1,3 CM - E PARTE INFERIORE IN PANNELLO DI MDF VERNICIATO

**GAMBE:** GAMBE IN METALLO VERNICIATO SP. 0,8 CM

**WOODEN TABLE**

**TOP:** UPPER TOP IN MDF PANEL VENEERED IN CANALETTO WALNUT 1.3 CM THICK - AND LOWER PART IN PAINTED MDF PANEL

**LEGS:** LEGS IN PAINTED METAL THICK. 0.8 CM

**TAVOLO LEGNO SPINATO**

**TOP:** TOP SUPERIORE IN MASSELLO DI NOCE CANALETTO SPAZZOLATO SP.1,3 CM - E PARTE INFERIORE IN PANNELLO DI MDF VERNICIATO

**GAMBE:** GAMBE IN METALLO VERNICIATO SP. 0,8 CM

**HERRINGBONE WOODEN TABLE**

**TOP:** UPPER TOP IN MDF PANEL VENEERED IN CANALETTO WALNUT 1.3 CM THICK - AND LOWER PART IN PAINTED MDF PANEL

**LEGS:** LEGS IN PAINTED METAL THICK. 0.8 CM

**TAVOLO CERAMICA**

**TOP:** TOP SUPERIORE IN CERAMICA 3D SP. 1,2 CM - E PARTE INFERIORE IN PANNELLO DI MDF VERNICIATO - TOT SP. 3,5 CM

**GAMBE:** GAMBE IN METALLO VERNICIATO SP. 0,8 CM

**CERAMIC TABLE**

**TOP:** FULL BODY CERAMIC TOP THICK. 1.2 CM - AND BOTTOM PART IN PANEL PAINTED MDF - TOT TH. 3.5 CM

**LEGS:** LEGS IN PAINTED METAL THICK. 0.8 CM

HOLE

### TAVOLO TWIST TWIST TABLE

#### PIANO IN LEGNO WOODEN TOP

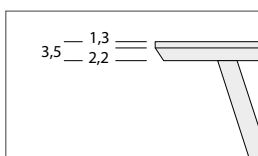
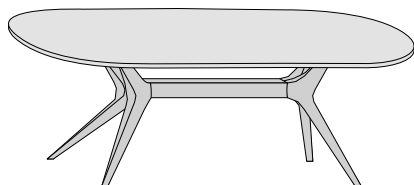

PROFILO PIANO LEGNO  
WOODEN TOP PROFILE

#### PIANO IN LEGNO SPINATO herringbone WOODEN TOP

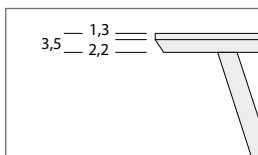
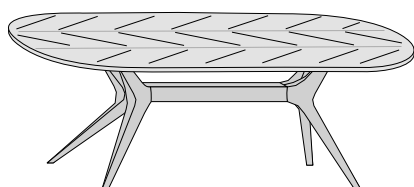

PROFILO PIANO LEGNO  
WOODEN TOP PROFILE

#### PIANO IN CERAMICA CERAMIC TOP

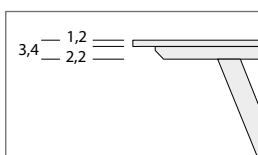
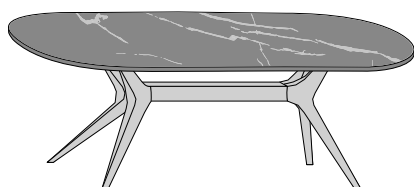

PROFILO PIANO CERAMICA  
CERAMIC TOP PROFILE

#### TAVOLO LEGNO

**TOP:** TOP SUPERIORE IN PANNELLO DI MDF IMPIALLACCIATO IN NOCE CANALETTO SP.1,3 CM - E PARTE INFERIORE IN PANNELLO DI MDF VERNICIATO

**GAMBE:** MASSELLO IN MASSELLO DI FAGGIO O MASSELLO DI NOCE CANALETTO

#### WOODEN TABLE

**TOP:** UPPER TOP IN MDF PANEL VENEERED IN CANALETTO WALNUT 1.3 CM THICK - AND LOWER PART IN PAINTED MDF PANEL

**LEGS:** SOLID BEECH OR CANALETTO WALNUT AND WITH PAINTED STEEL PLATES

#### TAVOLO LEGNO SPINATO

**TOP:** TOP SUPERIORE IN MASSELLO DI NOCE CANALETTO SPAZZOLATO SP.1,3 CM E PARTE INFERIORE IN PANNELLO DI MDF VERNICIATO

**GAMBE:** MASSELLO IN MASSELLO DI FAGGIO O MASSELLO DI NOCE CANALETTO

#### HERRINGBONE WOODEN TABLE

**TOP:** UPPER TOP IN MDF PANEL VENEERED IN CANALETTO WALNUT 1.3 CM THICK - AND LOWER PART IN PAINTED MDF PANEL

**LEGS:** SOLID BEECH OR CANALETTO WALNUT AND WITH PAINTED STEEL PLATES

#### TAVOLO CERAMICA

**TOP:** TOP SUPERIORE IN CERAMICA SP. 1,2 CM - E PARTE INFERIORE IN PANNELLO DI MDF VERNICIATO - TOT SP. 3,5 CM

**GAMBE:** MASSELLO IN MASSELLO DI FAGGIO O MASSELLO DI NOCE CANALETTO

#### CERAMIC TABLE

**TOP:** FULL BODY CERAMIC TOP THICK. 1.2 CM - AND BOTTOM PART IN PANEL PAINTED MDF - TOT TH. 3.5 CM

**LEGS:** SOLID BEECH OR CANALETTO WALNUT AND WITH PAINTED STEEL PLATES

CARATTERISTICHE TECNICHE  
TECHNICAL CHARACTERISTICS

**TAVOLO YORK**  
YORK TABLE

PIANO IN LEGNO  
WOODEN TOP

RETTANGOLARE  
RECTANGULAR

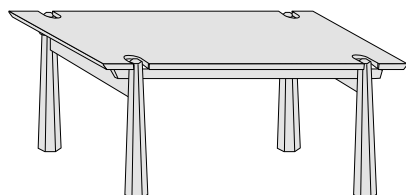

A BOTTE  
BARREL SHAPED

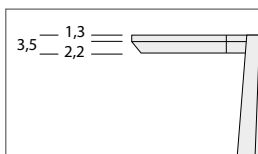
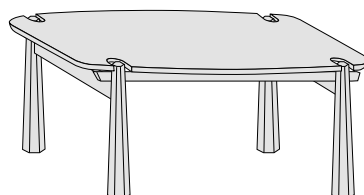

PROFILO PIANO LEGNO  
WOODEN TOP PROFILE

PIANO IN VETRO  
GLASS TOP

RETTANGOLARE  
RECTANGULAR

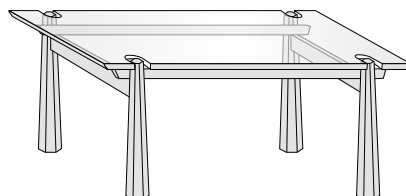

A BOTTE  
BARREL SHAPED

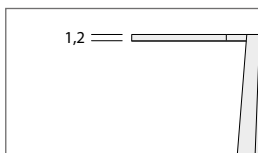
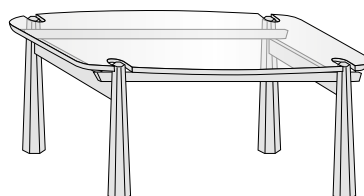

PROFILO PIANO VETRO  
GLASS TOP PROFILE

PIANO IN CERAMICA  
CERAMIC TOP

RETTANGOLARE  
RECTANGULAR

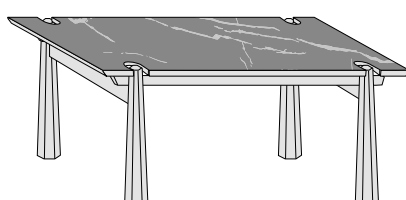

A BOTTE  
BARREL SHAPED

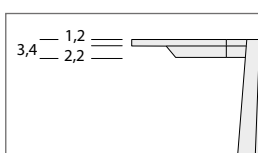
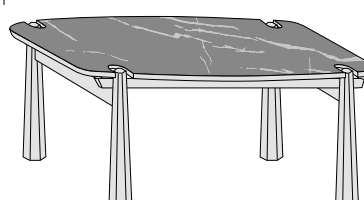

PROFILO PIANO CERAMICA  
CERAMIC TOP PROFILE

**TAVOLO LEGNO**

**TOP:** TOP SUPERIORE IN PANNELLO DI MDF IMPIALLACCIATO IN NOCE CANALETTO SP.1,3 CM - E PARTE INFERIORE IN PANNELLO DI MDF VERNICIATO

**GAMBE:** IN MDF IMPIALLACCIATO NOCE CANALETTO

**WOODEN TABLE**

**TOP:** UPPER TOP IN MDF PANEL VENEERED IN CANALETTO WALNUT 1.3 CM THICK - AND LOWER PART IN PAINTED MDF PANEL

**LEGS:** IN CANALETTO WALNUT VENEERED MDF

**PIANO IN VETRO**

**TOP:** VETRO EXTRA CHIARO TEMPERATO SP. 1.2 CON PIASTRE IN ACCIAIO VERNICIATO

**GAMBE:** IN MDF IMPIALLACCIATO NOCE CANALETTO

**GLASS TOP**

**TOP:** TEMPERED EXTRA-CLEAR GLASS TH. 1.2 WITH PAINTED STEEL PLATES

**LEGS:** IN CANALETTO WALNUT VENEERED MDF

**PIANO IN CERAMICA**

**TOP:** TOP SUPERIORE IN CERAMICA SP. 1,2 CM - E PARTE INFERIORE IN PANNELLO DI PARTICELLE DI LEGNO

**GAMBE:** IN MDF IMPIALLACCIATO NOCE CANALETTO

**CERAMIC TOP**

**TOP:** THICK CERAMIC TOP TOP. 1.2 CM - AND BOTTOM PART IN PANEL WOOD PARTICLES

**LEGS:** IN CANALETTO WALNUT VENEERED MDF

YORK

### TAVOLO FOSTER

#### FOSTER TABLE

PIANO IN LEGNO  
WOODEN TOP

RETTANGOLARE  
RECTANGULAR

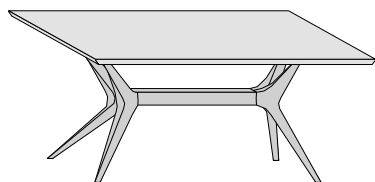

A BOTTE  
BARREL SHAPED

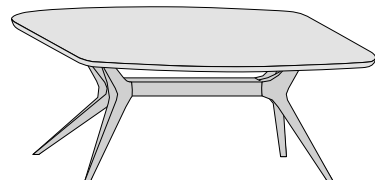

ROTONDO  
ROUND



ELLITTICO  
ELLIPTICAL

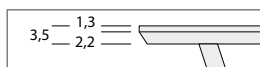

PROFILO PIANO LEGNO  
WOODEN TOP PROFILE

PIANO IN CRISTALLO  
GLASS TOP

RETTANGOLARE  
RECTANGULAR

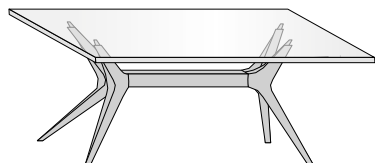

A BOTTE  
BARREL SHAPED

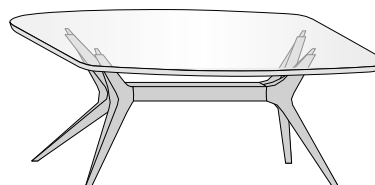

ROTONDO  
ROUND



ELLITTICO  
ELLIPTICAL

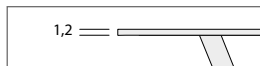

PROFILO PIANO LEGNO  
WOODEN TOP PROFILE

PIANO IN CERAMICA  
CERAMIC TOP

RETTANGOLARE  
RECTANGULAR

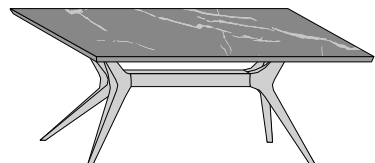

A BOTTE  
BARREL SHAPED

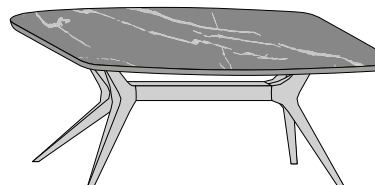

ROTONDO  
ROUND



ELLITTICO  
ELLIPTICAL

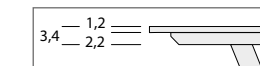

PROFILO PIANO LEGNO  
WOODEN TOP PROFILE

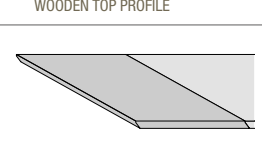
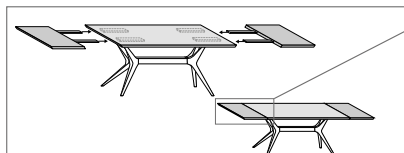

OPTIONAL: KIT 2 ALLUNGHE DA 45 DA ALLOGGIARE ESTERNAMENTE AL TAVOLO (FORNITE IN OPPOSITA BORSA IN TESSUTO IN DOTAZIONE)

### TAVOLO LEGNO

**TOP:** PANNELLO DI LISTELLARE RIVESTITO NOCE CANALETTO E STRUTTURA PERIMETRALE IN MASSELLO DI NOCE CANALETTO SP. 3

**ALLUNGHE:** (OPTIONAL) PER TAVOLO RETTANGOLARE: N.2 ALLUNGHE DA 45 CON GUIDE IN LEGNO IN PANNELLO DI LISTELLARE RIVESTITO NOCE CANALETTO E STRUTTURA PERIMETRALE IN MASSELLO DI NOCE CANALETTO SP. 3

**GAMBE:** MASSELLO DI FAGGIO O MASSELLO DI NOCE CANALETTO

**MISURE DISPONIBILI:** TAVOLO RETTANGOLARE: 180 X 100 CM. - 200 X 100 CM.  
TAVOLO ROTONDO: Ø 130, 140, 150, 160 CM.

### WOODEN TABLE

**TOP:** BLOCKBOARD PANEL COVERED IN CANALETTO WALNUT AND PERIMETRIC STRUCTURE IN SOLID CANALETTO WALNUT TH. 3

**EXTENSIONS:** (OPTIONAL) FOR RECTANGULAR TABLE: 2X45 CM WIDE EXTENSIONS WITH WOODEN GUIDES, IN BLOCKBOARD PANEL COVERED IN CANALETTO WALNUT AND PERIMETRIC STRUCTURE IN SOLID CANALETTO WALNUT TH. 3

**LEGS:** SOLID BEECH OR CANALETTO WALNUT

**AVAILABLE DIM.:** RECTANGULAR TABLE: 180 X 100 CM. - 200 X 100 CM.  
ROUND TABLE: Ø 130, 140, 150, 160 CM.

### TAVOLO VETRO

**TOP:** VETRO EXTRA CHIARO TEMPERATO SP. 1.2 CON PIASTRE IN ACCIAIO VERNICIATO

**GAMBE:** MASSELLO DI FAGGIO O MASSELLO DI NOCE CANALETTO E CON PIASTRE IN METALLO VERNICIATO

**MISURE DISPONIBILI:** TAVOLO RETTANGOLARE: 180 X 100 CM. - 200 X 100 CM.  
TAVOLO ROTONDO: Ø 130, 140, 150, 160 CM.

**VARIANTE DISPONIBILE:** VETRO FUMÉ

### GLASS TABLE

**TOP:** TEMPERED EXTRA-CLEAR GLASS TH. 1.2 WITH PAINTED STEEL PLATES

**LEGS:** SOLID BEECH OR CANALETTO WALNUT AND WITH PAINTED STEEL PLATES

**AVAILABLE DIM.:** RECTANGULAR TABLE: 180 X 100 CM. - 200 X 100 CM.  
ROUND TABLE: Ø 130, 140, 150, 160 CM.

**VARIANT AVAILABLE:** SMOKED GLASS

### TAVOLO CERAMICA

**TOP:** TOP SUPERIORE IN CERAMICA SP. 1,2 CM - E PARTE INFERIORE IN PANNELLO DI MDF VERNICIATO - TOT SP. 3,5 CM

**GAMBE:** MASSELLO IN MASSELLO DI FAGGIO O MASSELLO DI NOCE CANALETTO

### CERAMIC TABLE

**TOP:** FULL BODY CERAMIC TOP THICK. 1.2 CM - AND BOTTOM PART IN PANEL PAINTED MDF - TOT TH. 3.5 CM

**LEGS:** SOLID BEECH OR CANALETTO WALNUT AND WITH PAINTED STEEL PLATES



CARATTERISTICHE TECNICHE  
TECHNICAL CHARACTERISTICS

**TAVOLO NORMAN**  
NORMAN TABLE

PIANO VETRO EFFETTO MARMO  
GLASS TOP WITH MARBLE EFFECT

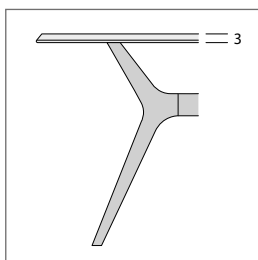
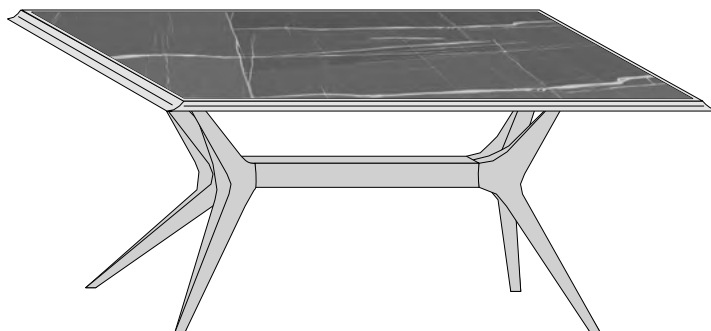

PROFILO PIANO  
TOP PROFILE

**TAVOLO LEGNO PIANO SAHARA NOIRE O KALACATTA**

**TOP:** PANNELLO DI LISTELLARE RIVESTITO NOCE CANALETTO SCAVATO E STRUTTURA PERIMETRALE IN MASSELLO DI NOCE CANALETTO SP. 3. INSERTO IN VETRO OPACO STAMPATO EFFETTO MARMO.

**GAMBE:** MASSELLO DI FAGGIO O MASSELLO DI NOCE CANALETTO  
NON SONO PREVISTE ALLUNGHE

**MISURE DISPONIBILI:** TAVOLO RETTANGOLARE: 180 X 100 CM. - 200 X 100 CM.

**WOODEN TABLE WITH SAHARA NOIRE OR KALACATTA TOP**

**TOP:** STRIP PANEL COVERED IN CANALETTO WALNUT AND STRUCTURE PERIMETER IN SOLID CANALETTO WALNUT SP. 3. INSERT IN PRINTED MATT GLASS MARBLE EFFECT.

**LEGS:** SOLID BEECH OR SOLID CANALETTO WALNUT

**AVAILABLE DIM.:** RECTANGULAR TABLE: 180 X 100 CM. - 200 X 100 CM.

### SEDIE CHAIRS

#### SHANGHAI

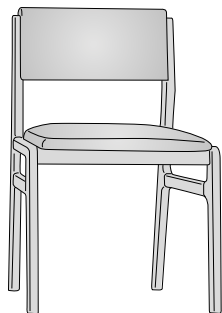

SENZA BRACCIOLO  
WITHOUT ARMREST

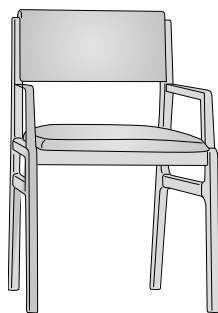

CON BRACCIOLO  
WITH ARMREST

#### SEDIA SHANGHAI

**FUSTO:** MASSELLO DI NOCE CANALETTO VERNICIATO

**SEDUTA:** PANNELLO IN MULTISTRATI PIOPPO IMBOTTITO IN GOMMAPIUMA E RIVESTITO CON TESSUTI DA CAMPIONARIO

#### DOMINO CHAIR

**CARCASE:** SOLID VARNISHED CANALETTO WALNUT

**SEAT:** POPLAR MULTILAYER PANEL UPHOLSTERED IN FOAM RUBBER AND COVERED WITH SAMPLE FABRICS

#### DOMINO

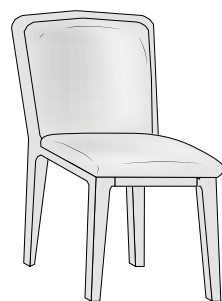

#### SEDIA DOMINO

**FUSTO:** MASSELLO DI NOCE CANALETTO O MASSELLO DI FAGGIO

**SEDUTA:** PANNELLO IN MULTISTRATI PIOPPO IMBOTTITO IN GOMMAPIUMA E RIVESTITO CON TESSUTI DA CAMPIONARIO

#### DOMINO CHAIR

**CARCASE:** SOLID CANALETTO WALNUT OR SOLID BEECH WOOD

**SEAT:** POPLAR MULTILAYER PANEL UPHOLSTERED IN FOAM RUBBER AND COVERED WITH SAMPLE FABRICS

#### BARCELONA



#### SEDIA BARCELONA

**FUSTO:** MASSELLO DI FAGGIO

**SEDUTA:** PANNELLO IN MULTISTRATI PIOPPO IMBOTTITO IN GOMMAPIUMA E RIVESTITO CON TESSUTI DA CAMPIONARIO

#### BARCELONA CHAIR

**CARCASE:** SOLID BEECH

**SEAT:** POPLAR MULTILAYER PANEL UPHOLSTERED IN FOAM RUBBER AND COVERED WITH SAMPLE FABRICS

#### BOLOGNA

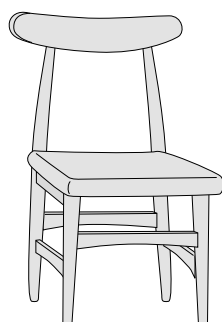

#### SEDIA BOLOGNA

**FUSTO:** MASSELLO DI NOCE CANALETTO O FAGGIO

**SEDUTA:** PANNELLO IN MULTISTRATI PIOPPO IMBOTTITO IN GOMMAPIUMA E RIVESTITO CON TESSUTI DA CAMPIONARIO

#### BOLOGNA CHAIR

**CARCASE:** SOLID CANALETTO WALNUT OR BEECH

**SEAT:** POPLAR MULTILAYER PANEL UPHOLSTERED IN FOAM RUBBER AND COVERED WITH SAMPLE FABRICS

#### CANWAREGIO

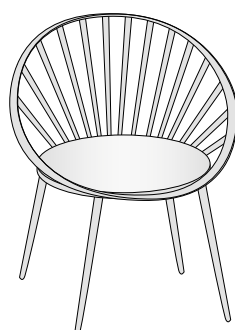

#### SEDIA VENEZIA

**FUSTO:** MASSELLO DI NOCE CANALETTO O FRASSINO

**OPTIONAL:** CUSCINO DA APPOGGIO IN GOMMAPIUMA E RIVESTITO CON TESSUTI DA CAMPIONARIO

#### VENEZIA CHAIR

**CARCASE:** SOLID CANALETTO WALNUT OR ASH

**OPTIONAL:** SUPPORT CUSHION IN FOAM RUBBER AND COVERED WITH FABRICS FROM THE SAMPLE BOOK

CARATTERISTICHE TECNICHE  
TECHNICAL CHARACTERISTICS

CONSOLLE  
CONSOLE

YORK

PIANO IN LEGNO  
WOODEN TOP

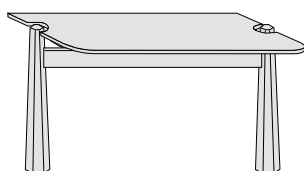

PIANO IN VETRO  
GLASS TOP

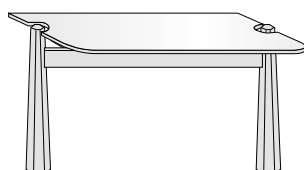

PIANO IN CERAMICA  
CERAMIC TOP

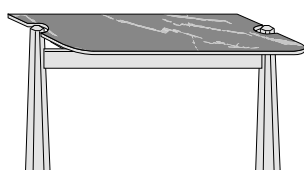

NON AUTOPORTANTE,  
NECESSARIO FISSAGGIO A MURO  
NOT SELF SUPPORTING,  
WALL MOUNTING NECESSARY

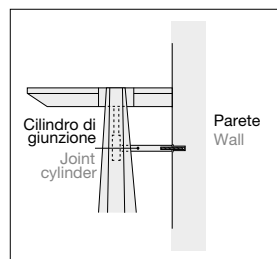

CONSOLLE LEGNO

TOP: TOP SUPERIORE IN PANNELLO DI MDF IMPIALLACCIATO IN NOCE CANALETTO SP.1,3 CM - E PARTE INFERIORE IN PANNELLO DI MDF VERNICIATO

GAMBE: IN MDF IMPIALLACCIATO NOCE CANALETTO

WOODEN CONSOLE

TOP: UPPER TOP IN MDF PANEL VENEERED IN CANALETTO WALNUT 1.3 CM THICK - AND LOWER PART IN PAINTED MDF PANEL

LEGS: IN CANALETTO WALNUT VENEERED MDF

CONSOLLE VETRO

TOP: VETRO EXTRA CHIARO TEMPERATO SP. 1.2 CON PIASTRE IN ACCIAIO VERNICIATO

GAMBE: IN MDF IMPIALLACCIATO NOCE CANALETTO

GLASS CONSOLE

TOP: TEMPERED EXTRA-CLEAR GLASS TH. 1.2 WITH PAINTED STEEL PLATES

LEGS: IN CANALETTO WALNUT VENEERED MDF

CONSOLLE CERAMICA

TOP: TOP SUPERIORE IN CERAMICA SP. 1,2 CM - E PARTE INFERIORE IN PANNELLO DI PARTICELLE DI LEGNO

GAMBE: IN MDF IMPIALLACCIATO NOCE CANALETTO

CERAMIC CONSOLE

TOP: THICK CERAMIC TOP TOP. 1.2 CM - AND BOTTOM PART IN PANEL WOOD PARTICLES

LEGS: IN CANALETTO WALNUT VENEERED MDF

HOLE

AUTOPORTANTE,  
SELF SUPPORTING,

PIANO IN LEGNO OVALE  
OVAL WOODEN TOP

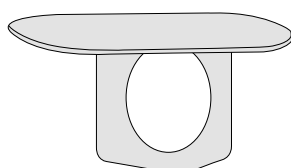

PIANO IN LEGNO SPINATO OVALE  
OVAL HERRINGBONE WOODEN TOP

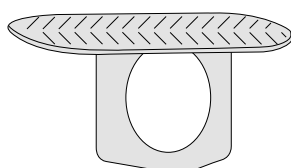

PIANO IN VETRO OVALE  
OVAL GLASS TOP

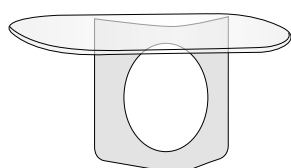

PIANO IN VETRO RETTANGOLARE  
RECTANGULAR GLASS TOP

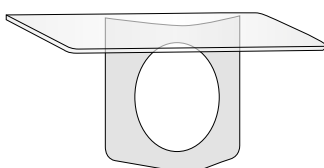

PIANO IN CERAMICA OVALE  
OVAL CERAMIC TOP

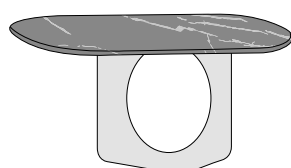

PIANO IN CERAMICA RETTANGOLARE  
RECTANGULAR CERAMIC TOP

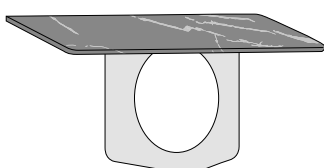

CONSOLLE LEGNO

TOP: TOP SUPERIORE IN PANNELLO DI MDF IMPIALLACCIATO IN NOCE CANALETTO SP.1,3 CM - E PARTE INFERIORE IN PANNELLO DI MDF VERNICIATO

GAMBE: GAMBE IN METALLO VERNICIATO SP. 0,8 CM

WOODEN CONSOLE

TOP: UPPER TOP IN MDF PANEL VENEERED IN CANALETTO WALNUT 1.3 CM THICK - AND LOWER PART IN PAINTED MDF PANEL

LEGS: LEGS IN PAINTED METAL THICK. 0.8 CM

CONSOLLE LEGNO SPINATO

TOP: TOP SUPERIORE IN MASSELLO DI NOCE CANALETTO SPAZZOLATO SP.1,3 CM - E PARTE INFERIORE IN PANNELLO DI MDF VERNICIATO

GAMBE: GAMBE IN METALLO VERNICIATO SP. 0,8 CM

HERRINGBONE WOODEN CONSOLE

TOP: UPPER TOP IN MDF PANEL VENEERED IN CANALETTO WALNUT 1.3 CM THICK - AND LOWER PART IN PAINTED MDF PANEL

LEGS: LEGS IN PAINTED METAL THICK. 0.8 CM

CONSOLLE CERAMICA

TOP: TOP SUPERIORE IN CERAMICA 3D SP. 1,2 CM - E PARTE INFERIORE IN PANNELLO DI MDF VERNICIATO - TOT SP. 3,5 CM

GAMBE: GAMBE IN METALLO VERNICIATO SP. 0,8 CM

CERAMIC CONSOLE

TOP: FULL BODY CERAMIC TOP THICK. 1.2 CM - AND BOTTOM PART IN PANEL PAINTED MDF - TOT TH. 3.5 CM

LEGS: LEGS IN PAINTED METAL THICK. 0.8 CM

### CONSOLE E SCRITTOI CONSOLE AND WRITING DESKS

SCRITTOIO E CONSOLE 1 CASSETTO  
1 DRAWER WRITING DESKS AND CONSOLE

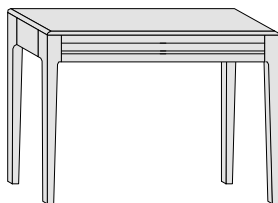

SHANGHAI

#### CONSOLE E SCRITTOIO

<b>STRUTTURA:</b>	PANNELLO DI LISTELLARE ESTERNO RIVESTITO IN NOCE CANALETTO E INTERNO RIVESTITO IN NOCE TANGANICA
<b>TOP:</b>	PANNELLO DI MDF IMPIALLACCIATO E BORDATO IN NOCE CANALETTO
<b>FRONTALE CASSETTO LEGNO:</b>	PANNELLO DI LISTELLARE RIVESTITO IN NOCE CANALETTO E IN NOCE TANGANICA SP. 2.9 CM – CON LISTELLI ORIZZONTALI IN MASSELLO DI NOCE CANALETTO
<b>CASSETTO:</b>	STRUTTURA IN PANNELLO DI MULTISTRATI BETULLA SPESSORE 1.5 CM , FONDO CASSETTO MULTISTRATI IMPIALLACCIATO FRASSINO SPESSORE 0.8 CM
<b>SPALLE:</b>	LEGNO FJ RIVESTITO NOCE CANALETTO SEZIONE 60/70X25
<b>PIEDI POSTERIORI:</b>	MASSELLO DI NOCE CANALETTO
<b>SCHIENALI:</b>	MULTISTRATO PIOPPO SPESSORE 0.8 CM.
<b>GUIDE:</b>	AMMORTIZZATE REGOLABILI IN ALTEZZA
<b>APERTURA</b>	MANIGLIA INTEGRATA IN LEGNO
<b>OPTIONAL PIANI:</b>	CERAMICA 3D SP. 1,2 CM

#### CONSOLE AND WRITING DESK

<b>STRUCTURE:</b>	BLOCKBOARD PANEL: OUTSIDE COVERED IN CANALETTO WALNUT, INSIDE COVERED IN TANGANICA WALNUT
<b>TOP:</b>	VENEERED MDF PANEL EDGED IN CANALETTO WALNUT
<b>WOODEN DRAWER FRONT:</b>	MULTILAYER PANEL COVERED IN CANALETTO WALNUT AND TANGANICA WALNUT SP. 2.9 CM - WITH HORIZONTAL STRIPS IN SOLID CANALETTO WALNUT
<b>DRAWER:</b>	STRUCTURE IN MULTILAYER BIRCH PANEL TH. 1.5 CM, DRAWER BOTTOM IN MULTILAYER ASHWOOD VENEERED TH. 0.8 CM
<b>SUPPORT PANELS:</b>	FJ WOOD COVERED IN CANALETTO WALNUT 60/70X25 SECTION
<b>BACK FEET:</b>	SOLID CANALETTO WALNUT
<b>BACK PANELS:</b>	POPLAR MULTILAYER TH. 0.8 CM.
<b>GUIDES:</b>	HEIGHT ADJUSTABLE SOFT-CLOSE GUIDES
<b>OPENING</b>	INTEGRATED WOODEN HANDLE
<b>OPTIONAL TOP:</b>	FULL BODY CERAMIC THICKNESS 1,2 CM

SCRITTOIO E CONSOLE 1 CASSETTO  
1 DRAWER WRITING DESKS AND CONSOLE

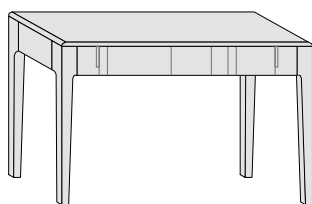

DOMINO

#### CONSOLE E SCRITTOIO

<b>STRUTTURA:</b>	PANNELLO DI LISTELLARE ESTERNO RIVESTITO IN NOCE CANALETTO E INTERNO RIVESTITO IN NOCE TANGANICA
<b>TOP:</b>	PANNELLO DI LISTELLARE RIVESTITO NOCE CANALETTO E STRUTTURA PERIMETRALE IN MASSELLO DI NOCE CANALETTO, SP 1.8
<b>FRONTALE CASSETTO LEGNO:</b>	PANNELLO DI LISTELLARE RIVESTITO INTERNAMENTE IN NOCE CANALETTO ED ESTERNAMENTE IN NOCE TANGANICA SP. 2.9 CM – CON DOGHE IN MULTISTRATI RIVESTITE NOCE CANALETTO E LATI IN MASSELLO DI NOCE CANALETTO SP. 0.3 CM
<b>CASSETTO:</b>	STRUTTURA IN PANNELLO DI MULTISTRATI BETULLA SPESSORE 1.5 CM , FONDO CASSETTO MULTISTRATI IMPIALLACCIATO FRASSINO SPESSORE 0.8 CM
<b>SPALLE:</b>	LEGNO FJ RIVESTITO NOCE CANALETTO SEZIONE 60/70X25
<b>PIEDI POSTERIORI:</b>	MASSELLO DI NOCE CANALETTO
<b>SCHIENALI:</b>	MULTISTRATO PIOPPO SPESSORE 0.8 CM.
<b>GUIDE:</b>	AMMORTIZZATE REGOLABILI IN ALTEZZA
<b>APERTURA</b>	MANIGLIA DOMINO SU DISEGNO
<b>OPTIONAL:</b>	PIANO IN MARMO

#### CONSOLE AND WRITING DESK

<b>STRUCTURE:</b>	BLOCKBOARD PANEL: OUTSIDE COVERED IN CANALETTO WALNUT, INSIDE COVERED IN TANGANICA WALNUT
<b>TOP:</b>	BLOCKBOARD PANEL COVERED IN CANALETTO WALNUT AND PERIMETRIC STRUCTURE IN SOLID CANALETTO WALNUT, TH 1.8
<b>WOODEN DRAWER FRONT:</b>	BLOCKBOARD PANEL COVERED INSIDE IN CANALETTO WALNUT, OUTSIDE IN TANGANICA WALNUT TH. 2.9 CM – WITH MULTILAYER SLATS COVERED IN CANALETTO WALNUT AND SIDES IN SOLID CANALETTO WALNUT TH. 0.3 CM
<b>DRAWER:</b>	STRUCTURE IN MULTILAYER BIRCH PANEL TH. 1.5 CM, DRAWER BOTTOM IN MULTILAYER ASHWOOD VENEERED TH. 0.8 CM
<b>SUPPORT PANELS:</b>	FJ WOOD COVERED IN CANALETTO WALNUT 60/70X25 SECTION
<b>BACK FEET:</b>	SOLID CANALETTO WALNUT
<b>BACK PANELS:</b>	POPLAR MULTILAYER TH. 0.8 CM.
<b>GUIDES:</b>	HEIGHT ADJUSTABLE SOFT-CLOSE GUIDES
<b>OPENING:</b>	DOMINO HANDLE AS IN THE DRAWING
<b>OPTIONAL:</b>	MARBLE TOP

CARATTERISTICHE TECNICHE  
TECHNICAL CHARACTERISTICS

TAVOLINI  
SMALL TABLES

YORK

PIANO IN LEGNO  
WOODEN TOP

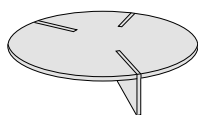

PIANO IN CERAMICA  
CERAMIC TOP

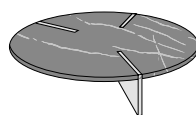

PIANO IN LEGNO

TOP: PANNELLO DI LISTELLARE IMPIALLACCIATO NOCE DA 4 CM E VERNICIATO

GAMBE: VETRO TEMPERATO TRASPARENTE O FUMÉ

WOODEN TOP

TOP: 4 CM WALNUT VENEERED AND PAINTED BLOCKBOARD PANEL

LEGS: TRANSPARENT OR SMOKED TEMPERED GLASS

PIANO IN CERAMICA

TOP: CERAMICA 3D SP. 1,2 CM

GAMBE: VETRO TEMPERATO TRASPARENTE O FUMÉ

CERAMIC TOP

TOP: FULL BODY CERAMIC THICKNESS 1,2 CM

LEGS: TRANSPARENT OR SMOKED TEMPERED GLASS

A TU PER TU

PIANO IN LEGNO E CERAMICA  
WOOD AND CERAMIC TOP

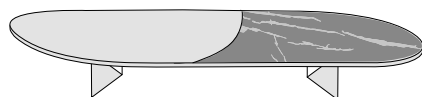

PIANO IN LEGNO  
WOODEN TOP



PIANO IN VETRO  
GLASS TOP

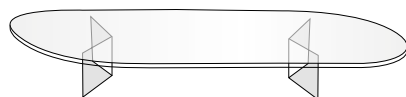

PIANO IN CERAMICA  
CERAMIC TOP



PIANO IN LEGNO E CERAMICA

TOP: CERAMICA 3D SP 1,2 CM E PANNELLO MULTISTRATO DI NOCE CANALETTO VERNICIATO

GAMBE: VETRO TEMPERATO TRASPARENTE O FUMÉ

WOOD AND CERAMIC TOP

TOP: FULL BODY CERAMIC THICKNESS 1,2 CM AND PAINTED CANALETTO WALNUT MULTILAYER PANEL

LEGS: TRANSPARENT OR SMOKED TEMPERED GLASS

PIANO IN LEGNO

TOP: PANNELLO DI MULTISTRATO DI NOCE CANALETTO SP. 1,2 CM VERNICIATO

GAMBE: VETRO TEMPERATO TRASPARENTE O FUMÉ

WOODEN TOP

TOP: CANALETTO WALNUT MULTILAYER PANEL THICK. 1.2 CM PAINTED

LEGS: TRANSPARENT OR SMOKED TEMPERED GLASS

PIANO IN VETRO

TOP: VETRO TEMPERATO TRASPARENTE O FUMÉ

GAMBE: VETRO TEMPERATO TRASPARENTE O FUMÉ

GLASS TOP

TOP: TRANSPARENT OR SMOKED TEMPERED GLASS

LEGS: TRANSPARENT OR SMOKED TEMPERED GLASS

PIANO IN CERAMICA

TOP: CERAMICA 3D SP 1,2 CM

GAMBE: VETRO TEMPERATO TRASPARENTE O FUMÉ

CERAMIC TOP

TOP: FULL BODY CERAMIC THICKNESS 1,2 CM

LEGS: TRANSPARENT OR SMOKED TEMPERED GLASS

### TAVOLINI SMALL TABLES

SHANGHAI

TAVOLINO QUADRATO  
SQUARE TABLE

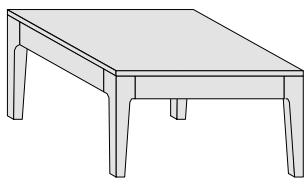

80 X 80 H. 40 CM.

TAVOLINO QUADRATO ALTO  
HIGH SQUARE TABLE

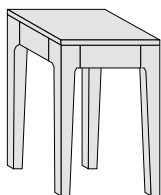

38 X 38 H. 60 CM.

TAVOLINO RETTANGOLARE  
RECTANGULAR TABLE

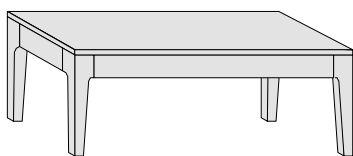

120 X 50 H. 40 CM.

### TAVOLINO QUADRATO E RETTANGOLARE

**TOP:** PANNELLO DI LISTELLARE RIVESTITO E BORDATO NOCE CANALETTO SP.1.8

**COLLETO:** PANNELLO DI LISTELLARE IMPIALLACCIATO IN NOCE CANALETTO

**GAMBE:** MASSELLO DI NOCE CANALETTO

**OPTIONAL PIANI:** VETRO EFFETTO MARMO (SAHARA NOIRE O KALACATTA) SP. 3 MM

### SQUARE AND RECTANGULAR TABLE

**TOP:** BLOCKBOARD PANEL COVERED IN CANALETTO WALNUT TH.1.8

**BAND:** BLOCKBOARD PANEL VENEERED IN CANALETTO WALNUT

**LEGS:** SOLID CANALETTO WALNUT

**TOP OPTIONAL:** GLASS MARBLE EFFECT (SAHARA NOIRE OR KALACATTA) TH. 3 MM

DOMINO

TAVOLINO QUADRATO  
SQUARE TABLE

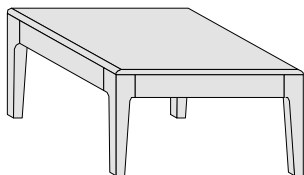

80 X 80 H. 40 CM.

TAVOLINO QUADRATO ALTO  
HIGH SQUARE TABLE

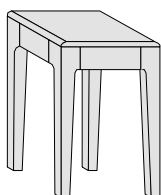

38 X 38 H. 60 CM.

TAVOLINO RETTANGOLARE  
RECTANGULAR TABLE

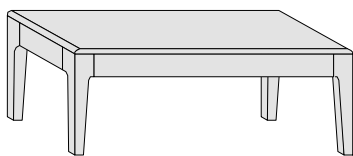

120 X 50 H. 40 CM.

### TAVOLINO QUADRATO E RETTANGOLARE

**TOP:** PANNELLO DI LISTELLARE RIVESTITO NOCE CANALETTO E STRUTTURA PERIMETRALE IN MASSELLO DI NOCE CANALETTO SP.1.8

**COLLETO:** PANNELLO DI LISTELLARE IMPIALLACCIATO IN NOCE CANALETTO

**GAMBE:** MASSELLO DI NOCE CANALETTO

**OPTIONAL PIANI:** MARMO SP. 20 MM

### SQUARE AND RECTANGULAR TABLE

**TOP:** BLOCKBOARD PANEL COVERED IN CANALETTO WALNUT AND PERIMETRIC STRUCTURE IN SOLID CANALETTO WALNUT TH.1.8

**BAND:** BLOCKBOARD PANEL VENEERED IN CANALETTO WALNUT

**LEGS:** SOLID CANALETTO WALNUT

**TOP OPTIONAL:** MARBLE TH. 20 MM

**CARATTERISTICHE TECNICHE**  
**TECHNICAL CHARACTERISTICS**
**SPECCHIERE**  
**MIRRORS**

**YORK**

PICCOLA  
SMALL

MEDIA  
MEDIUM

GRANDE  
LARGE

SPECCHIO ARGENTO  
SILVER MIRROR

VERTICALE  
VERTICAL

**SPECCHIERA**  
STRUTTURA IN LEGNO MASSELLO DI NOCE CANALETTO SP. 3 CM E VERNICIATO

**MIRROR**  
STRUCTURE IN SOLID CANALETTO WALNUT WOOD THICKNESS. 3 CM AND PAINTED

**DORIAN GRAY**

PICCOLA  
SMALL

MEDIA  
MEDIUM

GRANDE  
LARGE

SPECCHIO ARGENTO  
SILVER MIRROR

**SPECCHIERA**  
STRUTTURA IN METALLO SP. 0,5 CM VERNICIATO A POLVERI  
OPTIONAL: LUCE LED PERIMETRALE

**MIRROR**  
THICK METAL STRUCTURE. 0.5 CM POWDER COATED  
OPTIONAL: PERIMETER LED LIGHT

**DOMINO**

SPECCHIO FUMÈ  
SMOKED GREY MIRROR

SPECCHIO ARGENTO  
SILVER MIRROR

SPECCHIO BRONZO  
BRONZE MIRROR

POSIZIONAMENTO ORIZZONTALE O VERTICALE  
HORIZONTAL OR VERTICAL POSITION

**SPECCHIERA**  
PANNELLO DI MDF SP.1.8, LACCATO NERO. SPECCHI ARGENTO, BRONZO, FUMÈ.  
POSIZIONAMENTO ORIZZONTALE O VERTICALE  
SPECCHIO SPESSORE SP. CM. 0.4.

**MIRROR**  
MDF PANEL TH.1.8, BLACK LACQUERED. SILVER, BRONZE, FUME MIRRORS.  
HORIZONTAL OR VERTICAL POSITION.  
MIRROR THICKNESS TH. CM. 0.4.

**PEDRERA**

SPECCHIO ARGENTO  
SILVER MIRROR

**SPECCHIERA**  
PANNELLO DI MDF SP.1.8, LACCATO NERO. SPECCHI ARGENTO  
SPECCHIO SPESSORE SP. CM. 0.4.

**MIRROR**  
MDF PANEL TH.1.8, BLACK LACQUERED. SILVER MIRRORS.  
MIRROR THICKNESS TH. CM. 0.4.

**SHANGHAI**

BORDO IN LEGNO VERNICIATO  
PAGLIA DI VIENNA NATURALE  
E SPECCHIO ARGENTO  
PAINTED WOODEN EDGE  
NATURAL 'PAGLIA DI VIENNA'  
AND SILVER MIRROR

**SPECCHIERA**  
PANNELLO DI MDF IMPIALLACCIATO NOCE CANALETTO FINITURA NATURALE.  
RIVESTIMENTO IN MIDOLLINO INTRECCIATO "PAGLIA DI VIENNA"  
SPECCHIO ARGENTO

**MIRROR**  
CANALETTO WALNUT VENEER PANEL NATURAL FINISH. "VIENNA STRAW"  
WOVEN WICKER COVERING SILVER MIRROR

### SPECCHIERE MIRRORS

SINGAPORE

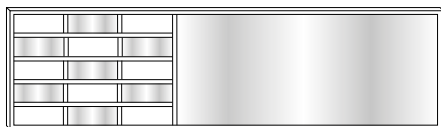

VERSIONE SPECCHIO ARGENTO E LEGNO  
SILVER MIRROR AND WOOD VERSION

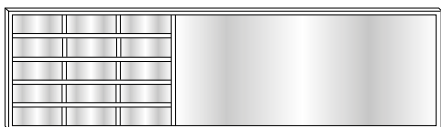

VERSIONE TUTTO SPECCHIO ARGENTO  
ALL SILVER MIRROR VERSION

#### SPECCHIERA

PANNELLO DI LISTELLARE IMPIALLACCIATO NOCE CANALETTO E BORDATO SP. CM 3.  
SPECCHIO ARGENTO  
VERSIONE SPECCHIO E LEGNO: ELEMENTI DECORATIVI IN LEGNO MASSELLO DI NOCE CANALETTO E PANNELLI IN MULTISTRATO IMPIALLACCIATO NOCE CANALETTO  
VERSIONE TUTTO SPECCHIO: ELEMENTI DECORATIVI IN LEGNO MASSELLO DI NOCE CANALETTO.

#### MIRROR

STRIP PANEL VENEERED CANALETTO WALNUT AND EDGED TH. CM 3.  
SILVER MIRROR  
MIRROR AND WOOD VERSION: DECORATIVE ELEMENTS IN SOLID CANALETTO WALNUT AND PANELS IN CANALETTO WALNUT VENEERED MULTILAYER  
FULL MIRROR VERSION: DECORATIVE ELEMENTS IN SOLID CANALETTO WALNUT.

THAI

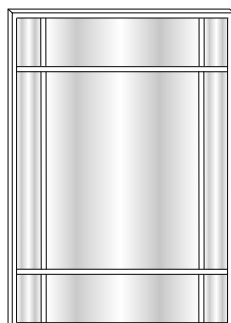

POSIZIONAMENTO ORIZZONTALE O VERTICALE  
HORIZONTAL OR VERTICAL POSITION

#### SPECCHIERA

PANNELLO DI LISTELLARE IMPIALLACCIATO NOCE CANALETTO E BORDATO.  
ELEMENTI DECORATIVI IN LEGNO MASSELLO DI NOCE CANALETTO.  
SPECCHIO ARGENTO

#### MIRROR

CANALETTO WALNUT VENEERED AND EDGED BLOCKBOARD PANEL.  
DECORATIVE ELEMENTS IN SOLID CANALETTO WALNUT WOOD.  
SILVER MIRROR

### COMÒ E COMODINI

#### CHEST OF DRAWERS AND BEDSIDE TABLES

OPERA

#### COMÒ 2 CASSETTI CHEST OF DRAWERS WITH 2 DRAWERS

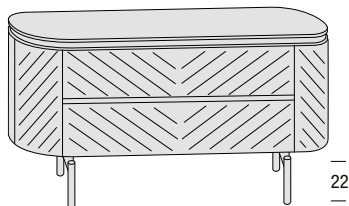

22

#### COMODINO 1 CASSETTO CON BASE METALLO BEDSIDE TABLE WITH 1 DRAWER AND METAL BASE

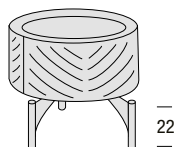

22

#### COMÒ E COMODINO CON BASE IN METALLO

- STRUTTURA:** PANNELLO IN MDF IMPIALLACCIATO NOCE CANALETTO  
**TOP:** LEGNO SP 1 CM, PANNELLO DI MULTISTRATO DI NOCE CANALETTO  
**FRONTALI CASSETTO:** MULTISTRATO DI LEGNO IMPIALLACCIATO NOCE CANALETTO SP.2.6 CM  
**MANIGLIA:** A GOLA IN LEGNO  
**PIEDI:** METALLO VERNICIATO  
**OPTIONAL PIANI:** CERAMICA 3D SP. 1,2 CM

#### CHEST OF DRAWERS AND BEDSIDE TABLE WITH METAL BASE

- STRUCTURE:** CANALETTO WALNUT VENEERED MDF PANEL  
**TOP:** 1 CM THICK WOOD, CANALETTO WALNUT MULTILAYER PANEL  
**DRAWER FRONTS:** MULTILAYER WOOD VENEERED WITH CANALETTO WALNUT THICKNESS 2.6 CM  
**HANDLE:** WOODEN GROOVE HANDLE  
**FEET:** PAINTED METAL  
**TOP OPTIONAL:** FULL BODY CERAMIC THICKNESS 1,2 CM

HARIBO

#### COMODINO 1 CASSETTO BEDSIDE TABLE WITH 1 DRAWER

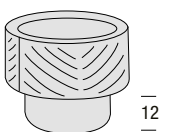

12

#### COMODINO 2 CASSETTI BEDSIDE TABLE WITH 2 DRAWERS

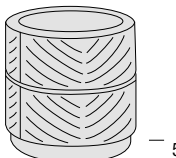

5

#### COMODINI CON BASE IN LEGNO

- STRUTTURA:** PANNELLO IN MDF IMPIALLACCIATO NOCE CANALETTO  
**TOP:** LEGNO SP 1 CM, PANNELLO DI MULTISTRATO DI NOCE CANALETTO  
**FRONTALI CASSETTO:** MULTISTRATO DI LEGNO IMPIALLACCIATO NOCE CANALETTO SP.2.6 CM  
**MANIGLIA:** A GOLA IN LEGNO  
**OPTIONAL PIANI:** CERAMICA 3D SP. 1,2 CM

#### BEDSIDE TABLES WITH WOODEN BASE

- STRUCTURE:** CANALETTO WALNUT VENEERED MDF PANEL  
**TOP:** 1 CM THICK WOOD, CANALETTO WALNUT MULTILAYER PANEL  
**DRAWER FRONTS:** MULTILAYER WOOD VENEERED WITH CANALETTO WALNUT THICKNESS 2.6 CM  
**HANDLE:** WOODEN GROOVE HANDLE  
**TOP OPTIONAL:** FULL BODY CERAMIC THICKNESS 1,2 CM



CARATTERISTICHE TECNICHE  
TECHNICAL CHARACTERISTICS

CANNAREGIO

**COMODINO 2 CASSETTI**  
BEDSIDE TABLE WITH 2 DRAWERS

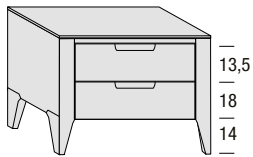

**COMÒ 3 CASSETTI**  
CHEST OF DRAWERS WITH 3 DRAWERS

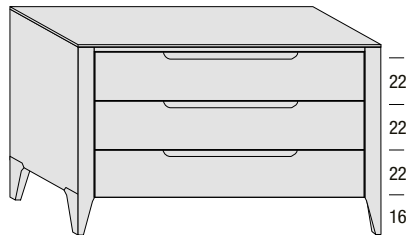

**COMODINO E COMÒ**

- STRUTTURA:** PANNELLO DI LISTELLARE ESTERNO RIVESTITO IN NOCE CANALETTO E INTERNO RIVESTITO IN NOCE TANGANICA
- TOP:** PANNELLO DI MDF IMPIALLACCIATO E BORDATO IN NOCE CANALETTO
- FRONTALE CASSETTO LEGNO:** PANNELLO DI LISTELLARE RIVESTITO IN NOCE CANALETTO E IN NOCE TANGANICA SP. 2.9 CM - CON LISTELLI ORIZZONTALI IN MASSELLO DI NOCE CANALETTO
- CASSETTO:** STRUTTURA IN PANNELLO DI MULTISTRATI BETULLA SPESSORE 1.5 CM , FONDO CASSETTO MULTISTRATI IMPIALLACCIATO FRASSINO SPESSORE 0.8 CM
- SPALLE:** LEGNO FJ RIVESTITO NOCE CANALETTO SEZIONE 60/70X25
- PIEDI POSTERIORI:** MASSELLO DI NOCE CANALETTO
- SCHIENALI:** MULTISTRATO PIOPPO SPESSORE 0.8 CM.
- GUIDE:** AMMORTIZZATE REGOLABILI IN ALTEZZA
- APERTURA** MANIGLIA IN METALLO FINITURA METAL GRAY
- OPTIONAL PIANI:** CERAMICA 3D SP. 1,2 CM

**BEDSIDE TABLE AND CHEST OF DRAWERS**

- STRUCTURE:** BLOCKBOARD PANEL: OUTSIDE COVERED IN CANALETTO WALNUT, INSIDE COVERED IN TANGANICA WALNUT
- TOP:** VENEERED MDF PANEL EDGED IN CANALETTO WALNUT
- WOODEN DRAWER FRONT:** MULTILAYER PANEL COVERED IN CANALETTO WALNUT AND TANGANICA WALNUT SP. 2.9 CM - WITH HORIZONTAL STRIPS IN SOLID CANALETTO WALNUT
- DRAWER:** STRUCTURE IN MULTILAYER BIRCH PANEL TH. 1.5 CM, DRAWER BOTTOM IN MULTILAYER ASHWOOD VENEERED TH. 0.8 CM
- SUPPORT PANELS:** FJ WOOD COVERED IN CANALETTO WALNUT 60/70X25 SECTION
- BACK FEET:** SOLID CANALETTO WALNUT
- BACK PANELS:** POPLAR MULTILAYER TH. 0.8 CM.
- GUIDES:** HEIGHT ADJUSTABLE SOFT-CLOSE GUIDES
- OPENING** METAL HANDLE IN METAL GRAY FINISH
- OPTIONAL TOP:** FULL BODY CERAMIC THICKNESS 1,2 CM

BOOK

**COMODINO 2 CASSETTI**  
BEDSIDE TABLE WITH 2 DRAWERS

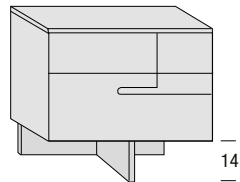

**COMÒ 3 CASSETTI**  
CHEST OF DRAWERS WITH 3 DRAWERS

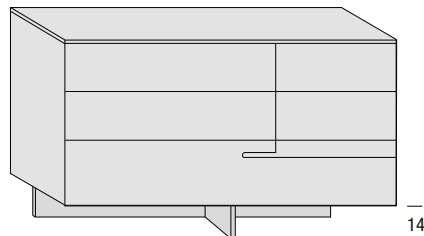

**COMODINO E COMÒ**

- STRUTTURA:** PANNELLO DI LISTELLARE ESTERNO RIVESTITO IN NOCE CANALETTO E INTERNO RIVESTITO IN NOCE TANGANICA
- TOP:** PANNELLO DI MDF IMPIALLACCIATO E BORDATO IN NOCE CANALETTO
- FRONTALE CASSETTO LEGNO:** PANNELLO DI LISTELLARE RIVESTITO IN NOCE CANALETTO E IN NOCE TANGANICA SP. 2.9 CM - CON LISTELLI ORIZZONTALI IN MASSELLO DI NOCE CANALETTO
- CASSETTO:** STRUTTURA IN PANNELLO DI MULTISTRATI BETULLA SPESSORE 1.5 CM , FONDO CASSETTO MULTISTRATI IMPIALLACCIATO FRASSINO SPESSORE 0.8 CM
- PIEDI POSTERIORI:** MASSELLO DI NOCE CANALETTO
- SCHIENALI:** MULTISTRATO PIOPPO SPESSORE 0.8 CM.
- GUIDE:** AMMORTIZZATE REGOLABILI IN ALTEZZA
- APERTURA** MANIGLIA INTEGRATA IN LEGNO
- OPTIONAL PIANI:** CERAMICA 3D SP. 1,2 CM

**BEDSIDE TABLE AND CHEST OF DRAWERS**

- STRUCTURE:** BLOCKBOARD PANEL: OUTSIDE COVERED IN CANALETTO WALNUT, INSIDE COVERED IN TANGANICA WALNUT
- TOP:** VENEERED MDF PANEL EDGED IN CANALETTO WALNUT
- WOODEN DRAWER FRONT:** MULTILAYER PANEL COVERED IN CANALETTO WALNUT AND TANGANICA WALNUT SP. 2.9 CM - WITH HORIZONTAL STRIPS IN SOLID CANALETTO WALNUT
- DRAWER:** STRUCTURE IN MULTILAYER BIRCH PANEL TH. 1.5 CM, DRAWER BOTTOM IN MULTILAYER ASHWOOD VENEERED TH. 0.8 CM
- BACK FEET:** SOLID CANALETTO WALNUT
- BACK PANELS:** POPLAR MULTILAYER TH. 0.8 CM.
- GUIDES:** HEIGHT ADJUSTABLE SOFT-CLOSE GUIDES
- OPENING** INTEGRATED WOODEN HANDLE
- OPTIONAL TOP:** FULL BODY CERAMIC THICKNESS 1,2 CM

### COMODINO 1 CASSETTO BEDSIDE TABLE WITH 1 DRAWER

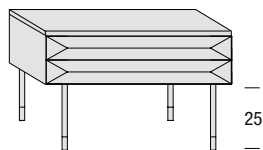

### COMÒ 3 CASSETTI CHEST OF DRAWERS WITH 3 DRAWERS

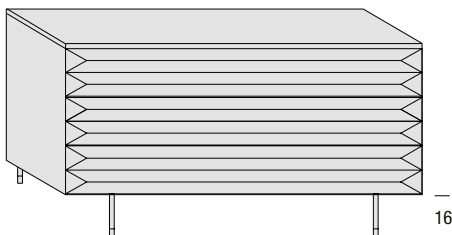

### COMODINO E COMÒ

<b>STRUTTURA:</b>	PANNELLO DI LISTELLARE ESTERNO RIVESTITO IN NOCE CANALETTO E INTERNO RIVESTITO IN NOCE TANGANICA
<b>TOP:</b>	PANNELLO DI MDF IMPIALLACCIATO E BORDATO IN NOCE CANALETTO
<b>FRONTALE CASSETTO LEGNO:</b>	PANNELLO DI LISTELLARE RIVESTITO IN NOCE CANALETTO E IN NOCE TANGANICA SP. 2.9 CM - CON LISTELLI ORIZZONTALI IN MASSELLO DI NOCE CANALETTO
<b>CASSETTO:</b>	STRUTTURA IN PANNELLO DI MULTISTRATI BETULLA SPESSORE 1.5 CM , FONDO CASSETTO MULTISTRATI IMPIALLACCIATO FRASSINO SPESSORE 0.8 CM
<b>PIEDI POSTERIORI:</b>	MASSELLO DI NOCE CANALETTO
<b>SCHIENALI:</b>	MULTISTRATO PIOPPO SPESSORE 0.8 CM.
<b>GUIDE:</b>	AMMORTIZZATE REGOLABILI IN ALTEZZA
<b>APERTURA</b>	MANIGLIA IN METALLO FINITURA METAL GRAY
<b>OPTIONAL PIANI:</b>	CERAMICA 3D SP. 1,2 CM

### BEDSIDE TABLE AND CHEST OF DRAWERS

<b>STRUCTURE:</b>	BLOCKBOARD PANEL: OUTSIDE COVERED IN CANALETTO WALNUT, INSIDE COVERED IN TANGANICA WALNUT
<b>TOP:</b>	VENEERED MDF PANEL EDGED IN CANALETTO WALNUT
<b>WOODEN DRAWER FRONT:</b>	MULTILAYER PANEL COVERED IN CANALETTO WALNUT AND TANGANICA WALNUT SP. 2.9 CM - WITH HORIZONTAL STRIPS IN SOLID CANALETTO WALNUT
<b>DRAWER:</b>	STRUCTURE IN MULTILAYER BIRCH PANEL TH. 1.5 CM, DRAWER BOTTOM IN MULTILAYER ASHWOOD VENEERED TH. 0.8 CM
<b>BACK FEET:</b>	SOLID CANALETTO WALNUT
<b>BACK PANELS:</b>	POPLAR MULTILAYER TH. 0.8 CM.
<b>GUIDES:</b>	HEIGHT ADJUSTABLE SOFT-CLOSE GUIDES
<b>OPENING</b>	METAL HANDLE IN METAL GRAY FINISH
<b>OPTIONAL TOP:</b>	FULL BODY CERAMIC THICKNESS 1,2 CM

YORK

### COMODINO 2 CASSETTI BEDSIDE TABLE WITH 2 DRAWERS

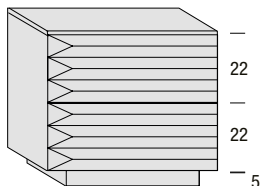

### COMÒ 3 CASSETTI CHEST OF DRAWERS WITH 3 DRAWERS

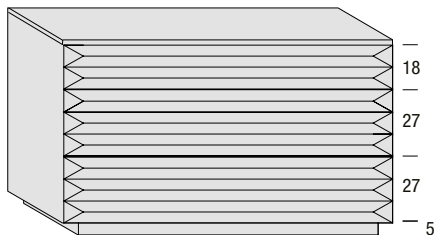

### COMÒ 6 CASSETTI CHEST OF DRAWERS WITH 6 DRAWERS

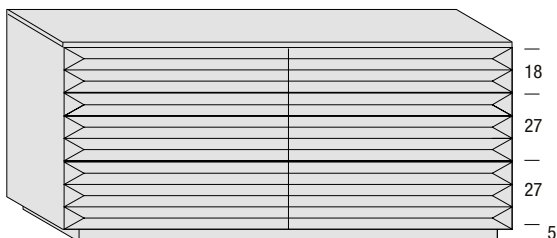

### COMODINO E COMÒ

<b>STRUTTURA:</b>	PANNELLO DI LISTELLARE ESTERNO RIVESTITO IN NOCE CANALETTO E INTERNO RIVESTITO IN NOCE TANGANICA
<b>TOP:</b>	PANNELLO DI MDF IMPIALLACCIATO E BORDATO IN NOCE CANALETTO
<b>FRONTALE CASSETTO LEGNO:</b>	PANNELLO DI LISTELLARE RIVESTITO IN NOCE CANALETTO E IN NOCE TANGANICA SP. 2.9 CM - CON LISTELLI ORIZZONTALI IN MASSELLO DI NOCE CANALETTO
<b>CASSETTO:</b>	STRUTTURA IN PANNELLO DI MULTISTRATI BETULLA SPESSORE 1.5 CM , FONDO CASSETTO MULTISTRATI IMPIALLACCIATO FRASSINO SPESSORE 0.8 CM
<b>PIEDI POSTERIORI:</b>	MASSELLO DI NOCE CANALETTO
<b>SCHIENALI:</b>	MULTISTRATO PIOPPO SPESSORE 0.8 CM.
<b>GUIDE:</b>	AMMORTIZZATE REGOLABILI IN ALTEZZA
<b>APERTURA</b>	MANIGLIA INTEGRATA IN LEGNO
<b>OPTIONAL PIANI:</b>	CERAMICA 3D SP. 1,2 CM

### BEDSIDE TABLE AND CHEST OF DRAWERS

<b>STRUCTURE:</b>	BLOCKBOARD PANEL: OUTSIDE COVERED IN CANALETTO WALNUT, INSIDE COVERED IN TANGANICA WALNUT
<b>TOP:</b>	VENEERED MDF PANEL EDGED IN CANALETTO WALNUT
<b>WOODEN DRAWER FRONT:</b>	MULTILAYER PANEL COVERED IN CANALETTO WALNUT AND TANGANICA WALNUT SP. 2.9 CM - WITH HORIZONTAL STRIPS IN SOLID CANALETTO WALNUT
<b>DRAWER:</b>	STRUCTURE IN MULTILAYER BIRCH PANEL TH. 1.5 CM, DRAWER BOTTOM IN MULTILAYER ASHWOOD VENEERED TH. 0.8 CM
<b>BACK FEET:</b>	SOLID CANALETTO WALNUT
<b>BACK PANELS:</b>	POPLAR MULTILAYER TH. 0.8 CM.
<b>GUIDES:</b>	HEIGHT ADJUSTABLE SOFT-CLOSE GUIDES
<b>OPENING</b>	INTEGRATED WOODEN HANDLE
<b>OPTIONAL TOP:</b>	FULL BODY CERAMIC THICKNESS 1,2 CM

MODI

CARATTERISTICHE TECNICHE  
TECHNICAL CHARACTERISTICS

SHANGHAI

**COMODINO 2 CASSETTI**  
BEDSIDE TABLE WITH 2 DRAWERS

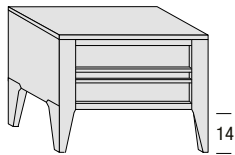

**COMÒ 3 CASSETTI**  
CHEST OF DRAWERS WITH 3 DRAWERS

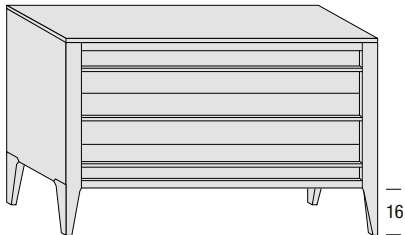

**CASSETTIERA 5 CASSETTI**  
5-DRAWER UNIT

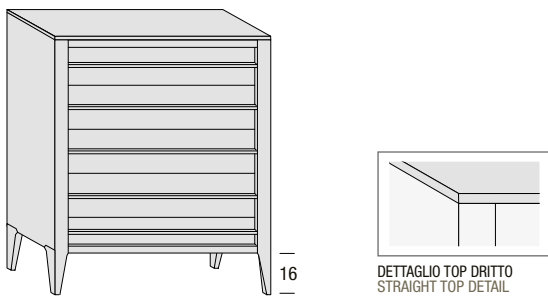

**COMODINO, COMÒ E CASSETTIERA**

- STRUTTURA:** PANNELLO DI LISTELLARE ESTERNO RIVESTITO IN NOCE CANALETTO E INTERNO RIVESTITO IN NOCE TANGANICA
- TOP:** PANNELLO DI MDF IMPIALLACCIATO E BORDATO IN NOCE CANALETTO
- FRONTALE CASSETTO LEGNO:** PANNELLO DI LISTELLARE RIVESTITO IN NOCE CANALETTO E IN NOCE TANGANICA SP. 2.9 CM - CON LISTELLI ORIZZONTALI IN MASSELLO DI NOCE CANALETTO
- CASSETTO:** STRUTTURA IN PANNELLO DI MULTISTRATI BETULLA SPESSORE 1.5 CM , FONDO CASSETTO MULTISTRATI IMPIALLACCIATO FRASSINO SPESSORE 0.8 CM
- SPALLE:** LEGNO FJ RIVESTITO NOCE CANALETTO SEZIONE 60/70X25
- PIEDI POSTERIORI:** MASSELLO DI NOCE CANALETTO
- SCHIENALI:** MULTISTRATO PIOPPO SPESSORE 0.8 CM.
- GUIDE:** AMMORTIZZATE REGOLABILI IN ALTEZZA
- APERTURA** MANIGLIA INTEGRATA IN LEGNO
- OPTIONAL PIANI:** CERAMICA 3D SP. 1,2 CM

**BEDSIDE TABLE, CHEST OF DRAWERS AND DRAWERS UNIT**

- STRUCTURE:** BLOCKBOARD PANEL: OUTSIDE COVERED IN CANALETTO WALNUT, INSIDE COVERED IN TANGANICA WALNUT
- TOP:** VENEERED MDF PANEL EDGED IN CANALETTO WALNUT
- WOODEN DRAWER FRONT:** MULTILAYER PANEL COVERED IN CANALETTO WALNUT AND TANGANICA WALNUT SP. 2.9 CM - WITH HORIZONTAL STRIPS IN SOLID CANALETTO WALNUT
- DRAWER:** STRUCTURE IN MULTILAYER BIRCH PANEL TH. 1.5 CM, DRAWER BOTTOM IN MULTILAYER ASHWOOD VENEERED TH. 0.8 CM
- SUPPORT PANELS:** FJ WOOD COVERED IN CANALETTO WALNUT 60/70X25 SECTION
- BACK FEET:** SOLID CANALETTO WALNUT
- BACK PANELS:** POPLAR MULTILAYER TH. 0.8 CM.
- GUIDES:** HEIGHT ADJUSTABLE SOFT-CLOSE GUIDES
- OPENING** INTEGRATED WOODEN HANDLE
- OPTIONAL TOP:** FULL BODY CERAMIC THICKNESS 1,2 CM

MEMPHIS

**COMODINO 2 CASSETTI**  
BEDSIDE TABLE WITH 2 DRAWERS

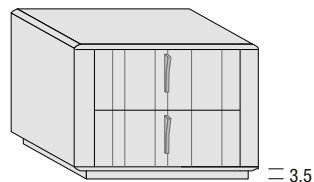

**COMÒ 3 CASSETTI**  
CHEST OF DRAWERS WITH 3 DRAWERS

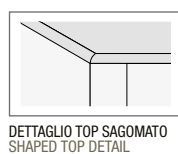
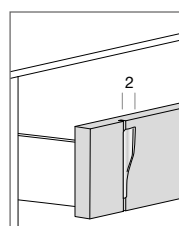
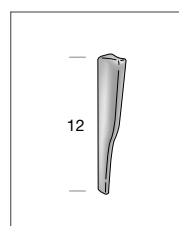
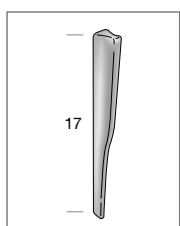
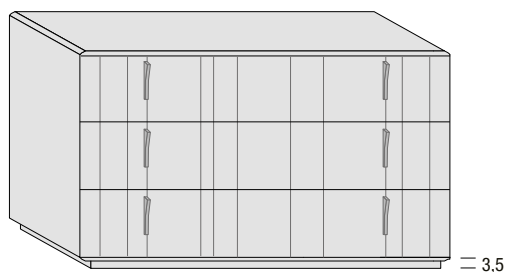

**COMODINO, COMÒ**

- STRUTTURA:** PANNELLO DI LISTELLARE ESTERNO RIVESTITO IN NOCE CANALETTO E INTERNO RIVESTITO IN NOCE TANGANICA
- TOP:** PANNELLO DI LISTELLARE RIVESTITO NOCE CANALETTO E STRUTTURA PERIMETRALE IN MASSELLO DI NOCE CANALETTO, SP. 1.8
- FRONTALE CASSETTO LEGNO:** PANNELLO DI LISTELLARE RIVESTITO INTERNAMENTE IN NOCE CANALETTO ED ESTERNAMENTE IN NOCE TANGANICA SP. 2.9 CM - CON DOGE IN MULTISTRATI RIVESTITE NOCE CANALETTO E LATI IN MASSELLO DI NOCE CANALETTO SP. 0.3 CM
- CASSETTO:** STRUTTURA IN PANNELLO DI MULTISTRATI BETULLA SPESSORE 1.5 CM , FONDO CASSETTO MULTISTRATI IMPIALLACCIATO FRASSINO SPESSORE 0.8 CM
- SPALLE:** LEGNO FJ RIVESTITO NOCE CANALETTO SEZIONE 60/70X25
- SCHIENALI:** MULTISTRATO PIOPPO SPESSORE 0.8 CM.
- ZOCCOLO:** PANNELLO DI MULTISTRATI PIOPPO SPESSORE 1.8 CM E STRUTTURA PERIMETRALE IN MASSELLO DI NOCE CANALETTO
- GUIDE:** AMMORTIZZATE REGOLABILI IN ALTEZZA
- APERTURA:** MANIGLIA DOMINO SU DISEGNO
- OPTIONAL:** PIANO IN MARMO SP. 2 CM

**BEDSIDE TABLE, CHEST OF DRAWERS**

- STRUCTURE:** BLOCKBOARD PANEL: OUTSIDE COVERED IN CANALETTO WALNUT, INSIDE COVERED IN TANGANICA WALNUT
- TOP:** BLOCKBOARD PANEL COVERED IN CANALETTO WALNUT AND PERIMETRIC STRUCTURE IN SOLID CANALETTO WALNUT, SP. 1.8
- WOODEN DRAWER FRONT:** BLOCKBOARD PANEL COVERED INSIDE IN CANALETTO WALNUT AND OUTSIDE IN TANGANICA WALNUT TH. 2.9 CM - WITH MULTILAYER SLATS COVERED IN CANALETTO WALNUT AND SIDES IN SOLID CANALETTO WALNUT TH. 0.3 CM
- DRAWER:** STRUCTURE IN BIRCH MULTILAYER PANEL TH. 1.5 CM , ASHWOOD VENEERED MULTILAYER DRAWER BOTTOM TH. 0.8 CM
- SUPPORT PANELS:** FJ WOOD COVERED IN CANALETTO WALNUT 60/70X25 SECTION
- BACK PANELS:** POPLAR MULTILAYER TH. 0.8 CM.
- PLINTH:** POPLAR MULTILAYER PANEL TH. 1.8 CM AND PERIMETRIC STRUCTURE IN SOLID CANALETTO WALNUT
- GUIDES:** HEIGHT ADJUSTABLE SOFT-CLOSE GUIDES
- OPENING:** DOMINO HANDLE AS IN THE DRAWING
- OPTIONAL:** MARBLE TOP TH. 2,0 CM.

### COMODINO 2 CASSETTI BEDSIDE TABLE WITH 2 DRAWERS

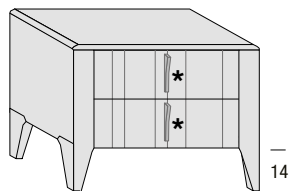

### COMÒ 3 CASSETTI CHEST OF DRAWERS WITH 3 DRAWERS

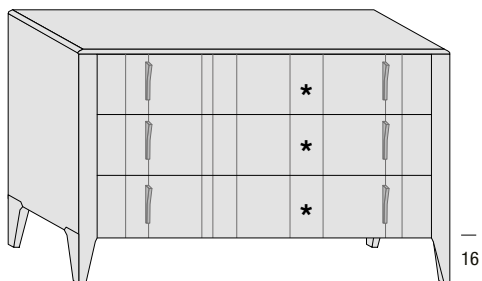

### CASSETTIERA 5 CASSETTI 5-DRAWER UNIT

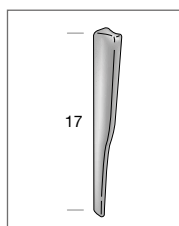
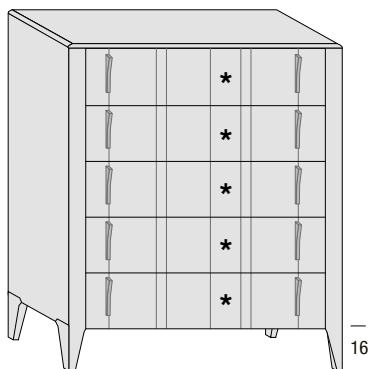

MANIGLIA GRANDE  
LARGE HANDLE

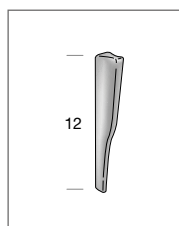

MANIGLIA PICCOLA  
SMALL HANDLE

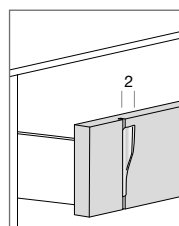

INCASTRO MANIGLIA  
HANDLE JOINT

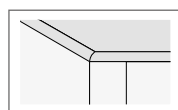

DETTAGLIO TOP SAGOMATO  
SHAPED TOP DETAIL



\* DOGA LEGNO LISCIA  
PLAIN WOODEN SLAT



\* DOGA RIGHE  
STRIPED SLAT



\* DOGA QUADRO LEGNO  
WOODEN SQUARE SLAT

### COMODINO, COMÒ E CASSETTIERA

<b>STRUTTURA:</b>	PANNELLO DI LISTELLARE ESTERNO RIVESTITO IN NOCE CANALETTO E INTERNO RIVESTITO IN NOCE TANGANICA
<b>TOP:</b>	PANNELLO DI LISTELLARE RIVESTITO NOCE CANALETTO E STRUTTURA PERIMETRALE IN MASSELLO DI NOCE CANALETTO, SP 1.8
<b>FRONTALE CASSETTO LEGNO:</b>	PANNELLO DI LISTELLARE RIVESTITO INTERNAMENTE IN NOCE CANALETTO ED ESTERNAMENTE IN NOCE TANGANICA SP. 2.9 CM – CON DOGE IN MULTISTRATI RIVESTITE NOCE CANALETTO E LATI IN MASSELLO DI NOCE CANALETTO SP. 0.3 CM
<b>CASSETTO:</b>	STRUTTURA IN PANNELLO DI MULTISTRATI BETULLA SPESSORE 1.5 CM , FONDO CASSETTO MULTISTRATI IMPIALLACCIATO FRASSINO SPESSORE 0.8 CM
<b>SPALLE:</b>	LEGNO FJ RIVESTITO NOCE CANALETTO SEZIONE 60/70X25
<b>PIEDI POSTERIORI:</b>	MASSELLO DI NOCE CANALETTO
<b>SCHIENALI:</b>	MULTISTRATO PIOPPO SPESSORE 0.8 CM.
<b>GUIDE:</b>	AMMORTIZZATE REGOLABILI IN ALTEZZA
<b>APERTURA</b>	MANIGLIA DOMINO SU DISEGNO
<b>OPTIONAL:</b>	PIANO IN MARMO SP. 2 CM

### BEDSIDE TABLE, CHEST OF DRAWERS AND DRAWERS UNIT

<b>STRUCTURE:</b>	BLOCKBOARD PANEL: OUTSIDE COVERED IN CANALETTO WALNUT, INSIDE COVERED IN TANGANICA WALNUT
<b>TOP:</b>	BLOCKBOARD PANEL COVERED IN CANALETTO WALNUT AND PERIMETRIC STRUCTURE IN SOLID CANALETTO WALNUT, TH 1.8
<b>WOODEN DRAWER FRONT:</b>	BLOCKBOARD PANEL COVERED INSIDE IN CANALETTO WALNUT, OUTSIDE IN TANGANICA WALNUT TH. 2.9 CM – WITH MULTILAYER SLATS COVERED IN CANALETTO WALNUT AND SIDES IN SOLID CANALETTO WALNUT TH. 0.3 CM
<b>DRAWER:</b>	STRUCTURE IN MULTILAYER BIRCH PANEL TH. 1.5 CM, DRAWER BOTTOM IN MULTILAYER ASHWOOD VENEERED TH. 0.8 CM
<b>SUPPORT PANELS:</b>	FJ WOOD COVERED IN CANALETTO WALNUT 60/70X25 SECTION
<b>BACK FEET:</b>	SOLID CANALETTO WALNUT
<b>BACK PANELS:</b>	POPLAR MULTILAYER TH. 0.8 CM.
<b>GUIDES:</b>	HEIGHT ADJUSTABLE SOFT-CLOSE GUIDES
<b>OPENING:</b>	DOMINO HANDLE AS IN THE DRAWING
<b>OPTIONAL:</b>	MARBLE TOP TH. 2,0 CM.

CARATTERISTICHE TECNICHE  
TECHNICAL CHARACTERISTICS

TOILETTE  
VANITY

SHANGHAI

TOILETTE 1 CASSETTO  
VANITY 1 DRAWER

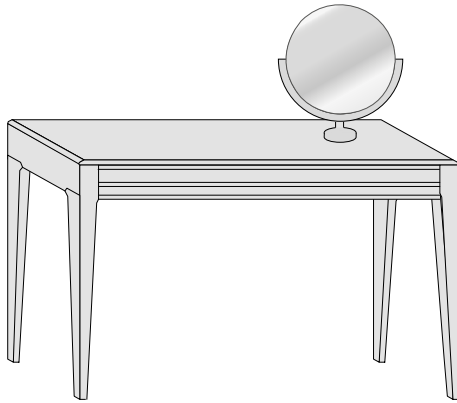

**INTERNO CASSETTO:** CASSETTO CON FONDO RIVESTITO IN ECONABUK E DIVISORI IN LEGNO MASSELLO DI NOCE CANALETTO.

**DRAWER INTERIOR:** DRAWER WITH ECONABUK COVERED BOTTOM AND SOLID CANALETTO WALNUT WOOD DIVIDERS.

CONSOLLE E SCRITTOIO

- STRUTTURA:** PANNELLO DI LISTELLARE ESTERNO RIVESTITO IN NOCE CANALETTO E INTERNO RIVESTITO IN NOCE TANGANICA
- TOP:** PANNELLO DI MDF IMPIALLACCIATO E BORDATO IN NOCE CANALETTO
- FRONTALE CASSETTO LEGNO:** PANNELLO DI LISTELLARE RIVESTITO IN NOCE CANALETTO E IN NOCE TANGANICA SP. 2.9 CM - CON LISTELLI ORIZZONTALI IN MASSELLO DI NOCE CANALETTO
- CASSETTO:** STRUTTURA IN PANNELLO DI MULTISTRATI BETULLA SPESSORE 1.5 CM , FONDO CASSETTO MULTISTRATI IMPIALLACCIATO FRASSINO SPESSORE 0.8 CM
- SPALLE:** LEGNO FJ RIVESTITO NOCE CANALETTO SEZIONE 60/70X25
- PIEDI POSTERIORI:** MASSELLO DI NOCE CANALETTO
- SCHIENALI:** MULTISTRATO PIOPPO SPESSORE 0.8 CM.
- GUIDE:** AMMORTIZZATE REGOLABILI IN ALTEZZA
- APERTURA** MANIGLIA INTEGRATA IN LEGNO
- OPTIONAL PIANI:** CERAMICA 3D SP. 1,2 CM
- SPECCHIO ORIENTABILE:** METALLO VERNICIATO

CONSOLE AND WRITING DESK

- STRUCTURE:** BLOCKBOARD PANEL: OUTSIDE COVERED IN CANALETTO WALNUT, INSIDE COVERED IN TANGANICA WALNUT
- TOP:** VENEERED MDF PANEL EDGED IN CANALETTO WALNUT
- WOODEN DRAWER FRONT:** MULTILAYER PANEL COVERED IN CANALETTO WALNUT AND TANGANICA WALNUT SP. 2.9 CM - WITH HORIZONTAL STRIPS IN SOLID CANALETTO WALNUT
- DRAWER:** STRUCTURE IN MULTILAYER BIRCH PANEL TH. 1.5 CM, DRAWER BOTTOM IN MULTILAYER ASHWOOD VENEERED TH. 0.8 CM
- SUPPORT PANELS:** FJ WOOD COVERED IN CANALETTO WALNUT 60/70X25 SECTION
- BACK FEET:** SOLID CANALETTO WALNUT
- BACK PANELS:** POPLAR MULTILAYER TH. 0.8 CM.
- GUIDES:** HEIGHT ADJUSTABLE SOFT-CLOSE GUIDES
- OPENING** INTEGRATED WOODEN HANDLE
- OPTIONAL TOP:** FULL BODY CERAMIC THICKNESS 1,2 CM
- ADJUSTABLE MIRROR:** PAINTED METAL

DOMINO

TOILETTE 1 CASSETTO  
VANITY 1 DRAWER

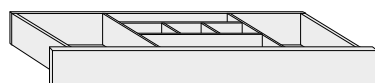
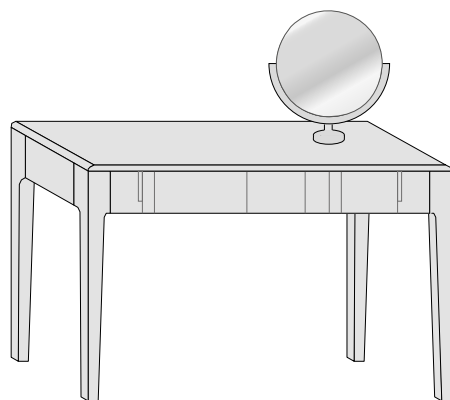

**INTERNO CASSETTO:** CASSETTO CON FONDO RIVESTITO IN ECONABUK E DIVISORI IN LEGNO MASSELLO DI NOCE CANALETTO.

**DRAWER INTERIOR:** DRAWER WITH ECONABUK COVERED BOTTOM AND SOLID CANALETTO WALNUT WOOD DIVIDERS.

CONSOLLE E SCRITTOIO

- STRUTTURA:** PANNELLO DI LISTELLARE ESTERNO RIVESTITO IN NOCE CANALETTO E INTERNO RIVESTITO IN NOCE TANGANICA
- TOP:** PANNELLO DI LISTELLARE RIVESTITO NOCE CANALETTO E STRUTTURA PERIMETRALE IN MASSELLO DI NOCE CANALETTO, SP 1.8
- FRONTALE CASSETTO LEGNO:** PANNELLO DI LISTELLARE RIVESTITO INTERNAMENTE IN NOCE CANALETTO ED ESTERNAMENTE IN NOCE TANGANICA SP. 2.9 CM - CON DOGHE IN MULTISTRATI RIVESTITE NOCE CANALETTO E LATI IN MASSELLO DI NOCE CANALETTO SP. 0.3 CM
- CASSETTO:** STRUTTURA IN PANNELLO DI MULTISTRATI BETULLA SPESSORE 1.5 CM , FONDO CASSETTO MULTISTRATI IMPIALLACCIATO FRASSINO SPESSORE 0.8 CM
- SPALLE:** LEGNO FJ RIVESTITO NOCE CANALETTO SEZIONE 60/70X25
- PIEDI POSTERIORI:** MASSELLO DI NOCE CANALETTO
- SCHIENALI:** MULTISTRATO PIOPPO SPESSORE 0.8 CM.
- GUIDE:** AMMORTIZZATE REGOLABILI IN ALTEZZA
- APERTURA** MANIGLIA DOMINO SU DISEGNO
- OPTIONAL:** PIANO IN MARMO SP. 2 CM
- SPECCHIO ORIENTABILE:** METALLO VERNICIATO

CONSOLE AND WRITING DESK

- STRUCTURE:** BLOCKBOARD PANEL: OUTSIDE COVERED IN CANALETTO WALNUT, INSIDE COVERED IN TANGANICA WALNUT
- TOP:** BLOCKBOARD PANEL COVERED IN CANALETTO WALNUT AND PERIMETRIC STRUCTURE IN SOLID CANALETTO WALNUT, TH 1.8
- WOODEN DRAWER FRONT:** BLOCKBOARD PANEL COVERED INSIDE IN CANALETTO WALNUT, OUTSIDE IN TANGANICA WALNUT TH. 2.9 CM - WITH MULTILAYER SLATS COVERED IN CANALETTO WALNUT AND SIDES IN SOLID CANALETTO WALNUT TH. 0.3 CM
- DRAWER:** STRUCTURE IN MULTILAYER BIRCH PANEL TH. 1.5 CM, DRAWER BOTTOM IN MULTILAYER ASHWOOD VENEERED TH. 0.8 CM
- SUPPORT PANELS:** FJ WOOD COVERED IN CANALETTO WALNUT 60/70X25 SECTION
- BACK FEET:** SOLID CANALETTO WALNUT
- BACK PANELS:** POPLAR MULTILAYER TH. 0.8 CM.
- GUIDES:** HEIGHT ADJUSTABLE SOFT-CLOSE GUIDES
- OPENING:** DOMINO HANDLE AS IN THE DRAWING
- OPTIONAL:** MARBLE TOP TH. 2,0 CM.
- ADJUSTABLE MIRROR:** PAINTED METAL

### POLTRONA, POUF E PANCHETTA ARMCHAIR, POUF AND BENCH

DOMINO

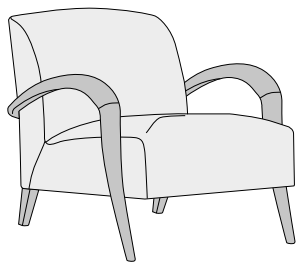

#### POLTRONA

**BRACCIOLI E BASE:** IN MASSELLO DI NOCE CANALETTO.

**SEDILE:** CON CINGHIE, POLIURETANO ESPANSO PF/35, MEMORY, DRACOM DOUPHON, TELA DI COTONE E RIVESTIMENTO DA CAMPIONARIO.

**SCHIENALE:** CON POLIURETANO ESPANSO EET/21, MEMORY, DRACOM DOUPHON, TELA DI COTONE E RIVESTIMENTO DA CAMPIONARIO.

#### ARMCHAIR

**ARMS AND BASE:** SOLID CANALETTO WALNUT

**SEAT:** WITH BELT, MEMORY, POLYURETHANE FOAM P/F 35, DRACOM DOUPHON, COTTON CANVAS AND COVER SAMPLES

**BACK:** WITH POLYURETHANE FOAM EET/21, MEMORY, DRACOM DOUPHON, COTTON CANVAS AND COVER SAMPLES.

DOMINO

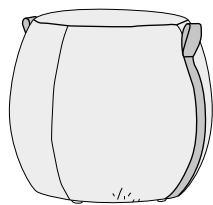

#### POUF

**BASE:** IN PANNELLO DI MULTISTRATO PIOPPO, POLIURETANO ESPANSO ET/30, FALDA IN RESINATO.

**CINGHIE:** IN CUOIO E RIVESTIMENTO CON TESSUTI DA CAMPIONARIO.

#### POUF

**BASE:** IN POPLAR MULTILAYER PANEL, POLYURETHANE FOAM ET/30, RESIN STRATUM

**BELTS:** LEATHER AND COVER SAMPLES

METRÒ

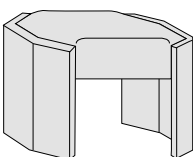
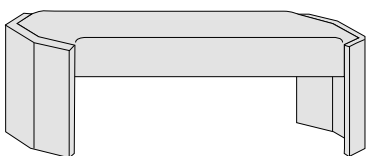

#### PANCHETTA E SGABELLO

**STRUTTURA:** IN PANNELLO DI MULTISTRATO PIOPPO, POLIURETANO ESPANSO ET/30, FALDA IN RESINATO.

#### BENCH AND STOOL

**STRUCTURE:** IN POPLAR MULTILAYER PANEL, POLYURETHANE FOAM ET/30, RESIN STRATUM

DOMINO

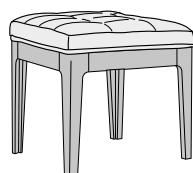
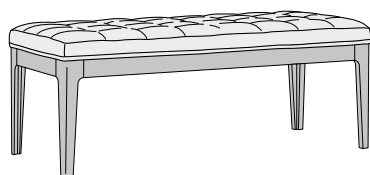

#### PANCHETTA E SGABELLO

**STRUTTURA:** IN LEGNO MASSELLO DI NOCE CANALETTO.

**IMBOTTITURA:** GOMMAPIUMA E RIVESTIMENTO DA CAMPIONARIO.

#### BENCH AND STOOL

**STRUCTURE:** IN SOLID CANALETTO WALNUT.

**PADDING:** FOAM AND COVER SAMPLES

CARATTERISTICHE TECNICHE  
TECHNICAL CHARACTERISTICS

LETTI  
BEDS

TESTIERA IMBOTTITA CON DECORO IN LEGNO SPINATO  
PADDED HEADBOARD VERSION WITH HERRINGBONE WOODEN DETAIL

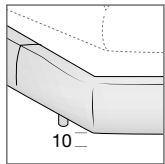
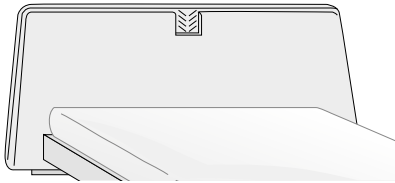

GIROLETTO IMBOTTITO  
UPHOLSTERED BED  
SORROUND

VERSIONE PANNELLO IMBOTTITO

- TESTIERA:** PANNELLO DI LEGNO ACCOPPIATO CON GOMMAPIUMA E RIVESTITO CON TESSUTI DA CAMPIONARIO . BORDO E DECORO IN PIACCLACCIO SPINATO DI NOCE CANALETTO
- PANNELLO:** GIROLETTO IN LEGNO DI PIOPPIO IMBOTTITO CON GOMMAPIUMA E TRAVERSO IN METALLO CON PIEDINI

VERSION UPHOLSTERED PANEL

- HEADBOARD:** WOODEN PANEL COUPLED WITH FOAM AND COVERED WITH FABRICS FROM SAMPLES. EDGE AND DECORATION IN CANALETTO WALNUT HERRINGBONE PLATE
- PANEL:** BED FRAME IN POPLAR WOOD PADDED WITH GMMAPIUMA AND METAL CROSSPIECE WITH FEET

DIMENSIONI TESTIERE  
HEADBOARD DIMENSIONS

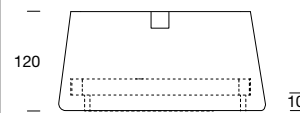

ONIGIRI

VERSIONE TESTIERA LEGNO  
WOODEN HEADBOARD VERSION



VERSIONE TESTIERA IMBOTTITA  
PADDED HEADBOARD VERSION



CUSCINI REMOVIBILI CON CLIPS  
REMOVABLE CUSHIONS WITH CLIPS

VERSIONE TESTIERA LEGNO

- TESTIERA:** PARTI CURVE: PANNELLO IN MULTISTRATI IMPIALLACCIATO NOCE CANALETTO. PARTI DRITE: PANNELLO DI MDF IMPIALLACCIATO NOCE CANALETTO. RETRO TESTATA: PANNELLO DI MDF IMPIALLACCIATO MELAMINICO COLORE NERO.
- GIROLETTO:** PANNELLO DI LISTELLARE IMPIALLACCIATO NOCE CANALETTO.
- NOTE PER MONTAGGIO: E' NECESSARIO FISSARE LA TESTATA ALLA PARETE CON L'APPOSITO KIT FERRAMENTA IN DOTAZIONE

WOODEN PANEL VERSION

- HEADBOARD:** CURVED PARTS: MULTILAYER PANEL VENEERED IN CANALETTO WALNUT. STRAIGHT PARTS: MDF PANEL VENEERED IN CANALETTO WALNUT. BACK OF HEADBOARD: MDF PANEL WITH BLACK MELAMINE VENEER.
- BED FRAME:** BLOCKBOARD PANEL VENEERED IN CANALETTO WALNUT
- ASSEMBLY NOTES: IT IS NECESSARY TO FIX THE HEADBOARD TO THE WALL WITH THE SPECIAL KIT HARDWARE SUPPLIED

VERSIONE PANNELLO IMBOTTITO

- TESTIERA:** PARTI CURVE: PANNELLO IN MULTISTRATI IMPIALLACCIATO NOCE CANALETTO. PARTI DRITE: PANNELLO DI MDF IMPIALLACCIATO NOCE CANALETTO. RETRO TESTATA: PANNELLO DI MDF IMPIALLACCIATO MELAMINICO COLORE NERO.
- IMBOTTITURA:** PANNELLO LISTELLARE ACCOPPIATO A GOMMAPIUMA RIVESTITO CON TESSUTI DA CAMPIONARIO
- GIROLETTO:** PANNELLO DI LISTELLARE IMPIALLACCIATO NOCE CANALETTO.
- NOTE PER MONTAGGIO: E' NECESSARIO FISSARE LA TESTATA ALLA PARETE CON L'APPOSITO KIT FERRAMENTA IN DOTAZIONE

WOODEN PANEL VERSION

- HEADBOARD:** CURVED PARTS: MULTILAYER PANEL VENEERED IN CANALETTO WALNUT. STRAIGHT PARTS: MDF PANEL VENEERED IN CANALETTO WALNUT. BACK OF HEADBOARD: MDF PANEL WITH BLACK MELAMINE VENEER.
- PADDING:** BLOCKBOARD PANEL COUPLED WITH FOAM RUBBER COVERED WITH FABRICS FROM THE SAMPLE BOOK
- BED FRAME:** BLOCKBOARD PANEL VENEERED IN CANALETTO WALNUT
- ASSEMBLY NOTES: IT IS NECESSARY TO FIX THE HEADBOARD TO THE WALL WITH THE SPECIAL KIT HARDWARE SUPPLIED

DIMENSIONI TESTIERE  
HEADBOARD DIMENSIONS

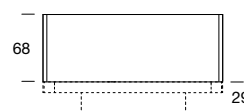

MILÀ

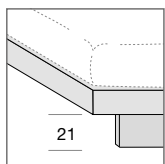

GIROLETTO FLUTTUANTE  
CON PIEDE IN VETRO  
FLOATING BED SORROUND  
WITH GLASS FEET

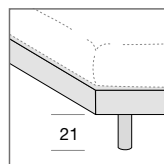

GIROLETTO FLUTTUANTE  
CON PIEDI METALLO  
FLOATING BED SORROUND  
WITH METAL FEETS

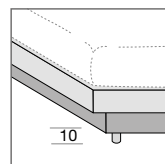

GIROLETTO FLUTTUANTE CON  
CONTENITORE IN METALLO.  
SPAZIO UTILE CONTENITORE  
H. 16 CM  
FLOATING BED SORROUND  
WITH METAL CONTAINER.  
USEFUL CONTAINER SPACE  
H. 16CM

### LETTI BEDS

#### VERSIONE TESTIERA LEGNO WOODEN HEADBOARD VERSION



#### VERSIONE TESTIERA IMBOTTITA PADDED HEADBOARD VERSION



CUSCINI REMOVIBILI CON CLIPS  
REMOVABLE CUSHIONS WITH CLIPS

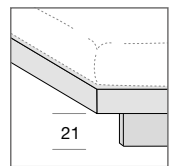

GIROLETTO FLUTTUANTE  
CON PIEDE IN VETRO  
FLOATING BED SORROUND  
WITH GLASS FEET

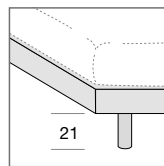

GIROLETTO FLUTTUANTE  
CON PIEDI METALLO  
FLOATING BED SORROUND  
WITH METAL FEET

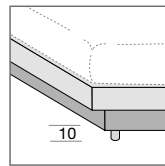

GIROLETTO FLUTTUANTE CON  
CONTENITORE IN METALLO.  
SPAZIO UTILE CONTENITORE  
H. 16 CM  
FLOATING BED SORROUND  
WITH METAL CONTAINER.  
USEFUL CONTAINER SPACE  
H. 16CM

#### VERSIONE TESTIERA LEGNO

**TESTIERA:** PARTI CURVE: PANNELLO IN MULTISTRATI IMPIALLACCIATO NOCE CANALETTO.  
PARTI DRITTE: PANNELLO DI MDF IMPIALLACCIATO NOCE CANALETTO.  
RETRO TESTATA: PANNELLO DI MDF IMPIALLACCIATO MELAMINICO COLORE NERO.

**GIROLETTO:** PANNELLO DI LISTELLARE IMPIALLACCIATO NOCE CANALETTO.

NOTE PER MONTAGGIO: E' NECESSARIO FISSARE LA TESTATA ALLA PARETE CON L'APPOSITO KIT FERRAMENTA IN DOTAZIONE

#### WOODEN PANEL VERSION

**HEADBOARD:** CURVED PARTS: MULTILAYER PANEL VENEERED IN CANALETTO WALNUT.  
STRAIGHT PARTS: MDF PANEL VENEERED IN CANALETTO WALNUT.  
BACK OF HEADBOARD: MDF PANEL WITH BLACK MELAMINE VENEER.

**BED FRAME:** BLOCKBOARD PANEL VENEERED IN CANALETTO WALNUT

ASSEMBLY NOTES: IT IS NECESSARY TO FIX THE HEADBOARD TO THE WALL WITH THE SPECIAL KIT HARDWARE SUPPLIED

#### VERSIONE PANNELLO IMBOTTITO

**TESTIERA:** PARTI CURVE: PANNELLO IN MULTISTRATI IMPIALLACCIATO NOCE CANALETTO.  
PARTI DRITTE: PANNELLO DI MDF IMPIALLACCIATO NOCE CANALETTO.  
RETRO TESTATA: PANNELLO DI MDF IMPIALLACCIATO MELAMINICO COLORE NERO.

**IMBOTTITURA:** PANNELLO LISTELLARE ACCOPPIATO A GOMMAPIUMA RIVESTITO CON TESSUTI DA CAMPIONARIO

**GIROLETTO:** PANNELLO DI LISTELLARE IMPIALLACCIATO NOCE CANALETTO.

NOTE PER MONTAGGIO: E' NECESSARIO FISSARE LA TESTATA ALLA PARETE CON L'APPOSITO KIT FERRAMENTA IN DOTAZIONE

#### WOODEN PANEL VERSION

**HEADBOARD:** CURVED PARTS: MULTILAYER PANEL VENEERED IN CANALETTO WALNUT.  
STRAIGHT PARTS: MDF PANEL VENEERED IN CANALETTO WALNUT.  
BACK OF HEADBOARD: MDF PANEL WITH BLACK MELAMINE VENEER.

**PADDING:** BLOCKBOARD PANEL COUPLED WITH FOAM RUBBER COVERED WITH FABRICS FROM THE SAMPLE BOOK

**BED FRAME:** BLOCKBOARD PANEL VENEERED IN CANALETTO WALNUT

ASSEMBLY NOTES: IT IS NECESSARY TO FIX THE HEADBOARD TO THE WALL WITH THE SPECIAL KIT HARDWARE SUPPLIED

#### DIMENSIONI TESTIERE HEADBOARD DIMENSIONS

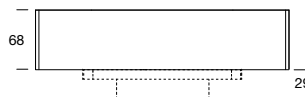

#### VERSIONE CON CONTENITORE VERSION WITH CONTAINER

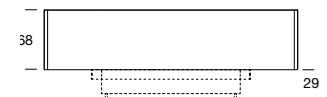

BOOK

#### VERSIONE TESTIERA IMBOTTITA PADDED HEADBOARD VERSION

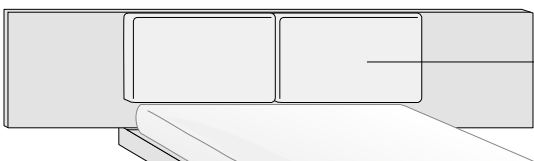

CUSCINI REMOVIBILI CON CLIPS  
REMOVABLE CUSHIONS WITH CLIPS

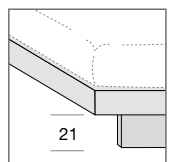

GIROLETTO FLUTTUANTE  
CON PIEDE IN VETRO  
FLOATING BED SORROUND  
WITH GLASS FEET

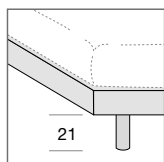

GIROLETTO FLUTTUANTE  
CON PIEDI METALLO  
FLOATING BED SORROUND  
WITH METAL FEET

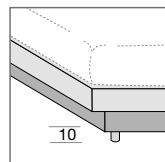

GIROLETTO FLUTTUANTE CON  
CONTENITORE IN METALLO.  
SPAZIO UTILE CONTENITORE  
H. 16 CM  
FLOATING BED SORROUND  
WITH METAL CONTAINER.  
USEFUL CONTAINER SPACE  
H. 16CM

#### VERSIONE PANNELLO IMBOTTITO

**TESTIERA:** PANNELLO DI LISTELLARE IMPIALLACCIATO NOCE CANALETTO.  
RETRO TESTATA: PANNELLO DI MDF IMPIALLACCIATO MELAMINICO COLORE NERO.

**IMBOTTITURA:** PANNELLO LISTELLARE ACCOPPIATO A GOMMAPIUMA RIVESTITO CON TESSUTI DA CAMPIONARIO

**GIROLETTO:** PANNELLO DI LISTELLARE IMPIALLACCIATO NOCE CANALETTO.

NOTE PER MONTAGGIO: E' NECESSARIO FISSARE LA TESTATA ALLA PARETE CON L'APPOSITO KIT FERRAMENTA IN DOTAZIONE

#### WOODEN PANEL VERSION

**HEADBOARD:** BLOCKBOARD PANEL VENEERED IN CANALETTO WALNUT.  
BACK OF HEADBOARD: MDF PANEL WITH BLACK MELAMINE VENEER.

**PADDING:** BLOCKBOARD PANEL COUPLED WITH FOAM RUBBER COVERED WITH FABRICS FROM THE SAMPLE BOOK

**BED FRAME:** BLOCKBOARD PANEL VENEERED IN CANALETTO WALNUT

ASSEMBLY NOTES: IT IS NECESSARY TO FIX THE HEADBOARD TO THE WALL WITH THE SPECIAL KIT HARDWARE SUPPLIED

#### DIMENSIONI TESTIERE HEADBOARD DIMENSIONS



#### VERSIONE CON CONTENITORE VERSION WITH CONTAINER

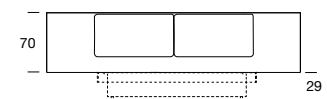

YORK



CARATTERISTICHE TECNICHE  
TECHNICAL CHARACTERISTICS

LETTI  
BEDS

VERSIONE TESTIERA IMBOTTITA  
PADDED HEADBOARD VERSION

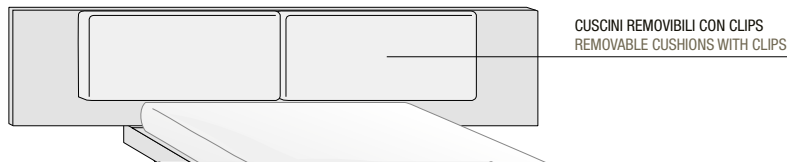

VERSIONE PANNELLO IMBOTTITO

- TESTIERA:** PANNELLO DI LISTELLARE IMPIALLACCIATO NOCE CANALETTO.  
RETRO TESTATA: PANNELLO DI MDF IMPIALLACCIATO MELAMINICO COLORE NERO.
- IMBOTTITURA:** PANNELLO LISTELLARE ACCOPPIATO A GOMMAPIUMA RIVESTITO CON TESSUTI DA CAMPIONARIO
- GIROLETTO:** PANNELLO DI LISTELLARE IMPIALLACCIATO NOCE CANALETTO.

NOTE PER MONTAGGIO: E' NECESSARIO FISSARE LA TESTATA ALLA PARETE CON L'APPOSITO KIT FERRAMENTA IN DOTAZIONE

WOODEN PANEL VERSION

- HEADBOARD:** BLOCKBOARD PANEL VENEERED IN CANALETTO WALNUT.  
BACK OF HEADBOARD: MDF PANEL WITH BLACK MELAMINE VENEER.
- PADDING:** BLOCKBOARD PANEL COUPLED WITH FOAM RUBBER COVERED WITH FABRICS FROM THE SAMPLE BOOK
- BED FRAME:** BLOCKBOARD PANEL VENEERED IN CANALETTO WALNUT

ASSEMBLY NOTES: IT IS NECESSARY TO FIX THE HEADBOARD TO THE WALL WITH THE SPECIAL KIT HARDWARE SUPPLIED

YORK SOFT

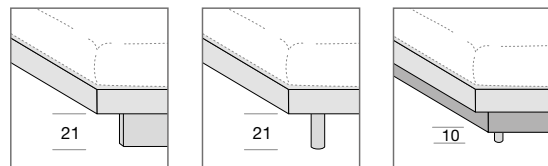

GIROLETTO FLUTTUANTE  
CON PIEDE IN VETRO  
FLOATING BED SURROUND  
WITH GLASS FEET

GIROLETTO FLUTTUANTE  
CON PIEDI METALLO  
FLOATING BED SURROUND  
WITH METAL FEET

GIROLETTO FLUTTUANTE CON  
CONTENITORE IN METALLO.  
SPAZIO UTILE CONTENITORE  
H. 16 CM  
FLOATING BED SURROUND  
WITH METAL CONTAINER.  
USEFUL CONTAINER SPACE  
H. 16CM

DIMENSIONI TESTIERE  
HEADBOARD DIMENSIONS

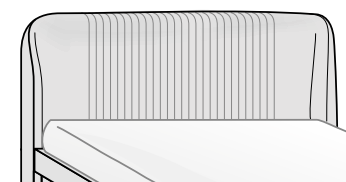
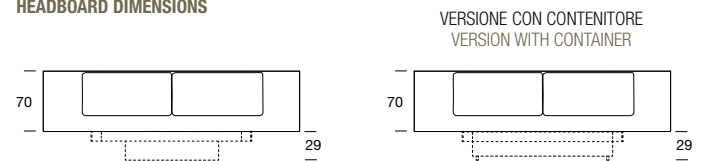

PANNELLO IMBOTTITO CON LAVORAZIONE A PLISSÉ  
UPHOLSTERED PANEL WORKED WITH PLEISSÉ

PANNELLO IMBOTTITO

- TESTIERA:** STRUTTURA IN MULTISTRATO DI PIOPIO DA 3 CM.
- RIVESTIMENTO:** TESSUTI E PELLI DA CAMPIONARIO CON LAVORAZIONE A PLISSÉ
- GIROLETTO LEGNO:** PANNELLO DI LISTELLARE IMPIALLACCIATO NOCE CANALETTO.

UPHOLSTERED PANEL

- HEADBOARD:** STRUCTURE IN 3 CM POPLAR MULTILAYER
- UPHOLSTERY:** FABRICS AND LEATHER FROM SAMPLES
- WOODEN BED FRAME:** BLOCKBOARD PANEL VENEERED IN CANALETTO WALNUT

DIMENSIONI TESTIERE  
HEADBOARD DIMENSIONS

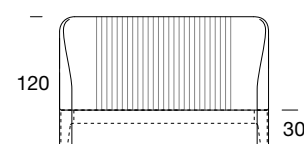

ALBA

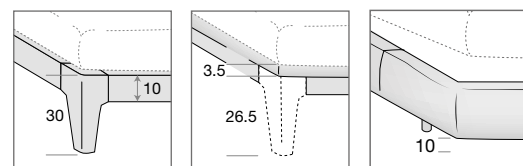

GIROLETTO LEGNO  
WOODEN BED SURROUND

GIROLETTO LEGNO E  
IMBOTTITO  
WOODEN BED SURROUND  
AND UPHOLSTERED  
BLOCKBOARD

GIROLETTO IMBOTTITO  
UPHOLSTERED BED  
SURROUND

### LETTI BEDS

#### VERSIONE TESTIERA IMBOTTITA PADDED HEADBOARD VERSION

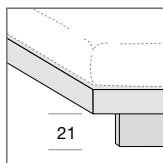
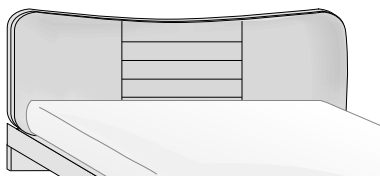

**GIROLETTO FLUTTUANTE  
CON PIEDE IN VETRO**  
FLOATING BED SURROUND  
WITH GLASS FEET

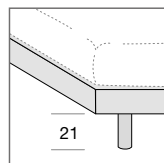

**GIROLETTO FLUTTUANTE  
CON PIEDI METALLO**  
FLOATING BED SURROUND  
WITH METAL FEETS

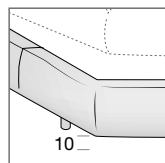

**GIROLETTO IMBOTTITO**  
UPHOLSTERED BED  
SURROUND

#### VERSIONE PANNELLO IMBOTTITO

**TESTIERA:** PANNELLO LISTELLARE SP. 3 CM ANTERIORMENTE RIVESTITO NOCE CANALETTO E BORDATO E POSTERIORMENTE IMPIALLACCIATO FRASSINO O TANGANICA.

**PANNELLO:** MULTISTRATI PIOPPO 1.5 CM IMBOTTITO IN GOMMAPIUMA CUCITO CON SCANALATURE VERTICALI E RIVESTITO CON TESSUTI DA CAMIONARIO

#### VERSION UPHOLSTERED PANEL

**HEADBOARD:** BLOCKBOARD PANEL TH. 3 CM. FRONT COVERED IN CANALETTO WALNUT AND EDGED, BACK VENEERED IN ASHWOOD OR TANGANICA

**PANEL:** POPLAR MULTILAYER 1.5 CM UPHOLSTERED WITH FOAM RUBBER WITH VERTICAL GROOVE AND COVERED WITH SAMPLE FABRICS

#### DIMENSIONI TESTIERE HEADBOARD DIMENSIONS

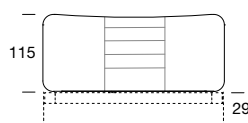

BIRKIN

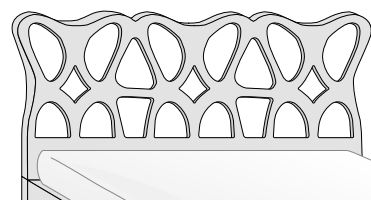

**PANNELLO TRAFORATO**  
PERFORATED PANEL

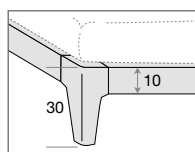

**GIROLETTO LEGNO IN PANNELLO  
LISTELLARE RIVESTITO NOCE  
CANALETTO - PIEDE IN MASSELLO  
DI NOCE CANALETTO**

WOODEN BED SURROUND IN  
BLOCKBOARD PANEL COVERED  
IN CANALETTO WALNUT -  
FOOT IN SOLID CANALETTO  
WALNUT

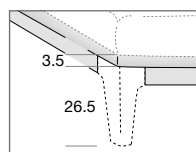

**GIROLETTO LEGNO E IMBOTTITO  
IN PANNELLO DI LISTELLARE NOCE  
CANALETTO E IMBOTTITO IN  
GOMMAPIUMA E RIVESTITO CON  
TESSUTI DA CAMPIONARIO -  
PIEDE IN MASSELLO DI NOCE  
CANALETTO**

WOODEN BED SURROUND AND  
UPHOLSTERED IN CANALETTO  
WALNUT BLOCKBOARD PANEL AND  
UPHOLSTERED IN FOAM RUBBER  
AND COVERED WITH SAMPLE  
FABRICS - FOOT IN SOLID  
CANALETTO WALNUT

#### PANNELLO LEGNO

**TESTIERA:** MASSELLO DI NOCE CANALETTO

#### WOODEN PANEL

**HEADBOARD:** CANALETTO WALNUT SOLID

#### DIMENSIONI TESTIERE HEADBOARD DIMENSIONS

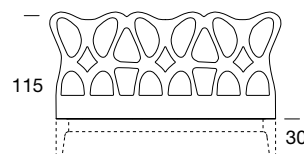

PEDRERA

CARATTERISTICHE TECNICHE  
TECHNICAL CHARACTERISTICS

LETTI  
BEDS

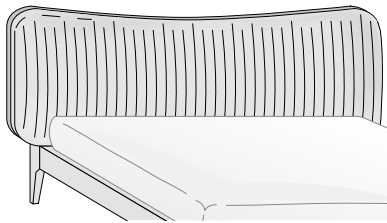

PANNELLO IMBOTTITO NON SFODERABILE  
UPHOLSTERED PANEL WITHOUT REMOVABLE COVER

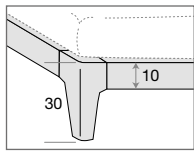

GIROLETTO LEGNO IN PANNELLO LISTELLARE RIVESTITO NOCE CANALETTO – PIEDE IN MASSELLO DI NOCE CANALETTO  
WOODEN BED SURROUND IN BLOCKBOARD PANEL COVERED IN CANALETTO WALNUT – FOOT IN SOLID CANALETTO WALNUT

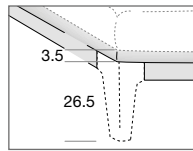

GIROLETTO LEGNO E IMBOTTITO IN PANNELLO DI LISTELLARE NOCE CANALETTO E IMBOTTITO IN GOMMAPIUMA E RIVESTITO CON TESSUTI DA CAMPIONARIO – PIEDE IN MASSELLO DI NOCE CANALETTO  
WOODEN BED SURROUND AND UPHOLSTERED IN CANALETTO WALNUT BLOCKBOARD PANEL AND UPHOLSTERED IN FOAM RUBBER AND COVERED WITH SAMPLE FABRICS – FOOT IN SOLID CANALETTO WALNUT

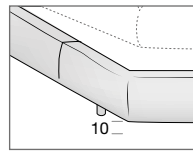

GIROLETTO IMBOTTITO STRUTTURA IN MULTISTRATO DI PIOPPO, IMBOTTITO IN GOMMAPIUMA E RIVESTITO CON TESSUTI DA CAMPIONARIO  
UPHOLSTERED BED SURROUND WITH STRUCTURE IN POPLAR MULTILAYER, UPHOLSTERED IN FOAM RUBBER AND COVERED WITH SAMPLE FABRICS

BUTTERFLY

PANNELLO IMBOTTITO

- TESTIERA:** PANNELLO LISTELLARE SP. 3 CM ANTERIORMENTE RIVESTITO NOCE CANALETTO E BORDATO E POSTERIORMENTE IMPIALLACCIATO FRASSINO O TANGANICA  
**PANNELLO:** MULTISTRATI PIOPPO 1.5 CM IMBOTTITO IN GOMMAPIUMA CUCITO CON SCANALATURE VERTICALI E RIVESTITO CON TESSUTI DA CAMPIONARIO

UPHOLSTERED PANEL

- HEADBOARD:** BLOCKBOARD PANEL TH. 3 CM. FRONT COVERED IN CANALETTO WALNUT AND EDGED, BACK VENEERED IN ASHWOOD OR TANGANICA  
**PANEL:** POPLAR MULTILAYER 1.5 CM UPHOLSTERED WITH FOAM RUBBER WITH VERTICAL GROOVE AND COVERED WITH SAMPLE FABRICS

DIMENSIONI TESTIERE  
HEADBOARD DIMENSIONS

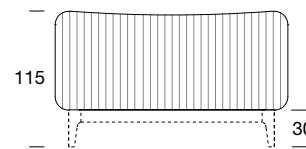

NON POSSIBILE MULTICOLORE SU RIVESTIMENTO TESTIERA  
NOT POSSIBLE MULTICOLOR ON HEADBOARD COVERING

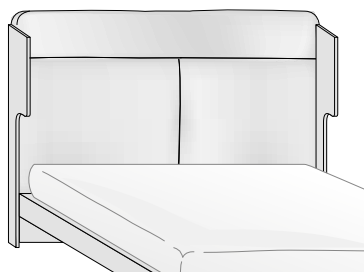

PANNELLO IMBOTTITO NON SFODERABILE  
UPHOLSTERED PANEL WITHOUT REMOVABLE COVER

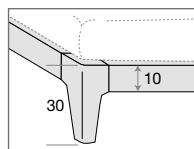

GIROLETTO LEGNO IN PANNELLO LISTELLARE RIVESTITO NOCE CANALETTO – PIEDE IN MASSELLO DI NOCE CANALETTO  
WOODEN BED SURROUND IN BLOCKBOARD PANEL COVERED IN CANALETTO WALNUT – FOOT IN SOLID CANALETTO WALNUT

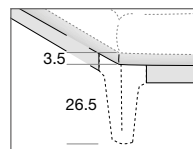

GIROLETTO LEGNO E IMBOTTITO IN PANNELLO DI LISTELLARE NOCE CANALETTO E IMBOTTITO IN GOMMAPIUMA E RIVESTITO CON TESSUTI DA CAMPIONARIO – PIEDE IN MASSELLO DI NOCE CANALETTO  
WOODEN BED SURROUND AND UPHOLSTERED IN CANALETTO WALNUT BLOCKBOARD PANEL AND UPHOLSTERED IN FOAM RUBBER AND COVERED WITH SAMPLE FABRICS – FOOT IN SOLID CANALETTO WALNUT

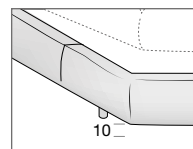

GIROLETTO IMBOTTITO STRUTTURA IN MULTISTRATO DI PIOPPO, IMBOTTITO IN GOMMAPIUMA E RIVESTITO CON TESSUTI DA CAMPIONARIO  
UPHOLSTERED BED SURROUND WITH STRUCTURE IN POPLAR MULTILAYER, UPHOLSTERED IN FOAM RUBBER AND COVERED WITH SAMPLE FABRICS

TOBIA

PANNELLO IMBOTTITO

- SPALLE TESTIERA:** MASSELLO DI NOCE CANALETTO  
**PANNELLO:** MULTISTRATI DI PIOPPO E PANNELLI IN MULTISTRATI BETULLA IMBOTTITI IN GOMMAPIUMA E RIVESTITI CON TESSUTI DA CAMPIONARIO

UPHOLSTERED PANEL

- HEADBOARD SIDES:** CANALETTO WALNUT SOLID  
**PANEL:** MULTILAYER OF POPLAR AND BIRCH MULTILAYER PANEL, FOAM RUBBER UPHOLSTERED AND SAMPLES FABRIC COVERED

DIMENSIONI TESTIERE  
HEADBOARD DIMENSIONS

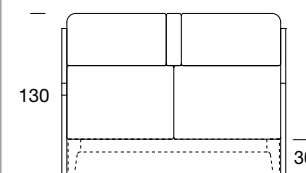

### LETTI BEDS

DOMINO

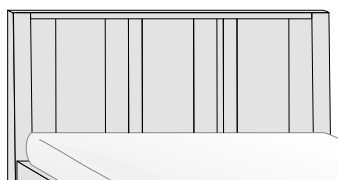

**PANNELLO A DOGHE LEGNO**  
WOODEN SLATS PANEL



**PANNELLO IMBOTTITO A DOGHE NON SFODERABILE**  
UPHOLSTERED SLATTED PANEL WITHOUT REMOVABLE COVER

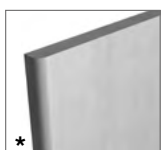

**DOGA LEGNO LISCIA**  
PLAIN WOODEN SLAT

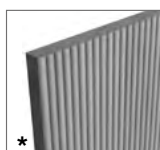

**DOGA RIGHE**  
STRIPED SLAT

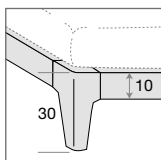

**GIROLETTO LEGNO**  
WOODEN BED SURROUND

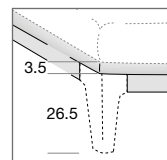

**GIROLETTO LEGNO E IMBOTTITO**  
WOODEN BED SURROUND AND UPHOLSTERED BLOCKBOARD

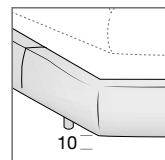

**GIROLETTO IMBOTTITO**  
UPHOLSTERED BED SURROUND

#### VERSIONE PANNELLO CON DOGHE LEGNO

**TESTIERA** STRUTTURA IN MASSELLO DI NOCE CANALETTO

**PANNELLO** MULTISTRATI IMPIALLACCIATO NOCE CANALETTO E DOGHE APPLICATE IN MASSELLO DI NOCE CANALETTO

#### WOODEN SLATS PANEL VERSION

**HEADBOARD** STRUCTURE IN SOLID CANALETTO WALNUT

**PANEL** MULTILAYER PANEL VENEERED IN CANALETTO WALNUT AND SLATS IN SOLID CANALETTO WALNUT

#### VERSIONE PANNELLO IMBOTTITO A DOGHE

**TESTIERA** STRUTTURA IN MASSELLO DI NOCE CANALETTO

**PANNELLO** MULTISTRATI PIOPIO IMBOTTITO IN GOMMAPIUMA E RIVESTITO CON TESSUTI DA CAMPIONARIO

#### VERSION UPHOLSTERED PANEL WITH SLATS

**HEADBOARD** STRUCTURE IN SOLID CANALETTO WALNUT

**PANEL** POPLAR MULTILAYER PANEL UPHOLSTERED WITH FOAM RUBBER AND COVERED WITH SAMPLE FABRICS

#### DIMENSIONI TESTIERE HEADBOARD DIMENSIONS

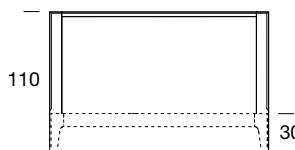

SHANGHAI

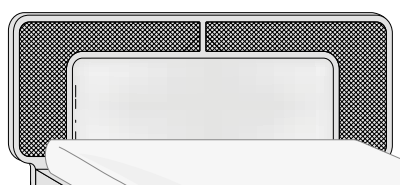

**PANNELLO IMBOTTITO CON PARTE IMBOTTITA E PARTE IN PAGLIA DI VIENNA**  
UPHOLSTERED PANEL WITH PADDED PART AND PART IN VIENNA STRAW

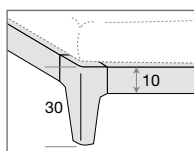

**GIROLETTO LEGNO IN PANNELLO LISTELLARE RIVESTITO NOCE CANALETTO - PIEDE IN MASSELLO DI NOCE CANALETTO**  
WOODEN BED SURROUND IN BLOCKBOARD PANEL COVERED IN CANALETTO WALNUT - FOOT IN SOLID CANALETTO WALNUT

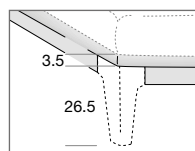

**GIROLETTO LEGNO E IMBOTTITO IN PANNELLO DI LISTELLARE NOCE CANALETTO E IMBOTTITO IN GOMMAPIUMA E RIVESTITO CON TESSUTI DA CAMPIONARIO - PIEDE IN MASSELLO DI NOCE CANALETTO**  
WOODEN BED SURROUND AND UPHOLSTERED IN CANALETTO WALNUT BLOCKBOARD PANEL AND UPHOLSTERED IN FOAM RUBBER AND COVERED WITH SAMPLE FABRICS - FOOT IN SOLID CANALETTO WALNUT

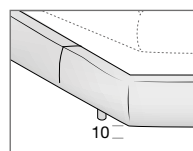

**GIROLETTO IMBOTTITO STRUTTURA IN MULTISTRATO DI PIOPIO, IMBOTTITO IN GOMMAPIUMA E RIVESTITO CON TESSUTI DA CAMPIONARIO**  
UPHOLSTERED BED SURROUND WITH STRUCTURE IN POPLAR MULTILAYER, UPHOLSTERED IN FOAM RUBBER AND COVERED WITH SAMPLE FABRICS

#### PANNELLO IMBOTTITO

**TESTIERA** STRUTTURA IN LISTELLARE IMPIALLACCIATO NOCE CANALETTO, BORDATO NOCE CANALETTO E CURVATO. PANNELLI SUPERIORI IN MIDOLLINO INTRECCIATI "PAGLIA DI VIENNA". PANNELLO INFERIORE IMBOTTITO IN GOMMAPIUMA RIVESTITO CON TESSUTI O PELLI DA CAMPIONARIO

#### UPHOLSTERED PANEL

**HEADBOARD** STRUCTURE IN LISTELLAR VENEERED CANALETTO WALNUT, EDGED CANALETTO WALNUT AND CURVED. TOP PANELS IN WICKEN WOVEN "VIENNA STRAW". LOWER PANEL PADDED IN FOAM-FOAM COVERED WITH FABRICS OR LEATHER FROM SAMPLE

#### DIMENSIONI TESTIERE HEADBOARD DIMENSIONS

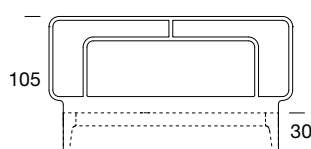

CARATTERISTICHE TECNICHE  
TECHNICAL CHARACTERISTICS

LETTI  
BEDS

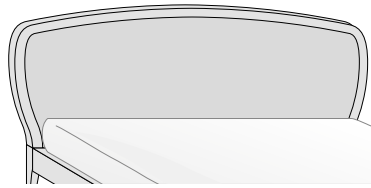

PANNELLO LEGNO  
WOODEN PANEL

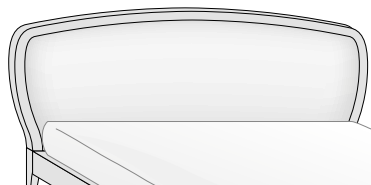

PANNELLO IMBOTTITO, OPZIONALE VERSIONE SFODERABILE  
UPHOLSTERED PANEL, OPTIONAL VERSION WITH REMOVABLE COVER

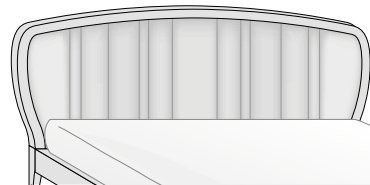

PANNELLO IMBOTTITO A DOGHE, NON SFODERABILE  
NON POSSIBILE MULTICOLORE SU TESSUTO TESTIERA  
SLATTED UPHOLSTERED PANEL, NOT REMOVABLE COVER  
MULTICOLOR ON HEADBOARD FABRIC NOT POSSIBLE

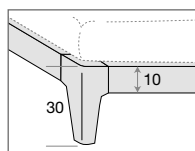

GIROLETTO LEGNO IN PANNELLO LISTELLARE RIVESTITO NOCE CANALETTO - PIEDE IN MASSELLO DI NOCE CANALETTO

WOODEN BED SURROUND IN BLOCKBOARD PANEL COVERED IN CANALETTO WALNUT - FOOT IN SOLID CANALETTO WALNUT

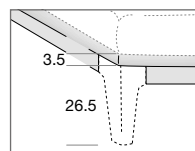

GIROLETTO LEGNO E IMBOTTITO IN PANNELLO DI LISTELLARE NOCE CANALETTO E IMBOTTITO IN GOMMAPIUMA E RIVESTITO CON TESSUTI DA CAMPIONARIO - PIEDE IN MASSELLO DI NOCE CANALETTO

WOODEN BED SURROUND AND UPHOLSTERED IN CANALETTO WALNUT BLOCKBOARD PANEL AND UPHOLSTERED IN FOAM RUBBER AND COVERED WITH SAMPLE FABRICS - FOOT IN SOLID CANALETTO WALNUT

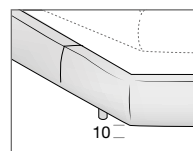

GIROLETTO IMBOTTITO STRUTTURA IN MULTISTRATO DI PIOPPO, IMBOTTITO IN GOMMAPIUMA E RIVESTITO CON TESSUTI DA CAMPIONARIO

UPHOLSTERED BED SURROUND WITH STRUCTURE IN POPLAR MULTILAYER, UPHOLSTERED IN FOAM RUBBER AND COVERED WITH SAMPLE FABRICS

VERSIONE PANNELLO LEGNO

**TESTIERA** STRUTTURA IN PANNELLO LISTELLARE RIVESTITO NOCE CANALETTO, BORDATO NOCE CANALETTO E CURVATO  
**PANNELLO** MULTISTRATI IMPIALLACCIATO NOCE CANALETTO

WOODEN PANEL VERSION

**HEADBOARD** STRUTTURA IN PANNELLO LISTELLARE RIVESTITO NOCE CANALETTO, BORDATO NOCE CANALETTO E CURVATO  
**PANEL** MULTISTRATI IMPIALLACCIATO NOCE CANALETTO

VERSIONE PANNELLO IMBOTTITO E IMBOTTITO A DOGHE

**TESTIERA** STRUTTURA IN PANNELLO LISTELLARE RIVESTITO NOCE CANALETTO, BORDATO NOCE CANALETTO  
**PANNELLO** MULTISTRATI IMPIALLACCIATO NOCE CANALETTO E RIVESTITO CON TESSUTI DA CAMPIONARIO

VERSION WITH UPHOLSTERED PANEL AND UPHOLSTERED WITH SLAT

**HEADBOARD** STRUTTURA IN PANNELLO LISTELLARE RIVESTITO NOCE CANALETTO, BORDATO NOCE CANALETTO E CURVATO  
**PANEL** MULTISTRATI IMPIALLACCIATO NOCE CANALETTO E RIVESTITO CON TESSUTI DA CAMPIONARIO

DIMENSIONI TESTIERE

HEADBOARD DIMENSIONS

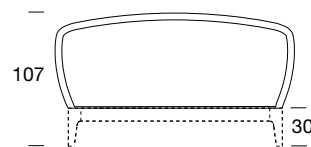

NON POSSIBILE MULTICOLORE SU RIEVSTIMENTO TESTIERA  
NOT POSSIBLE MULTICOLOR ON HEADBOARD COVERING

BATTLÒ

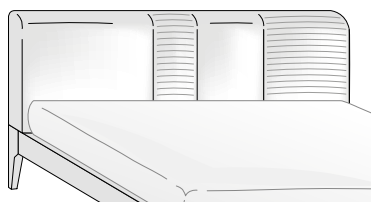

PANNELLO IMBOTTITO CON 2 CUSCINI LISCI E 2 CUSCINI CON CUCITURA BARRÈ, NON SFODERABILE  
UPHOLSTERED PANEL WITH 2 PLAIN CUSHIONS AND 2 CUSHIONS WITH BARRÈ SEAM, WITHOUT REMOVABLE COVER

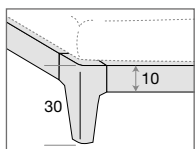

GIROLETTO LEGNO IN PANNELLO LISTELLARE RIVESTITO NOCE CANALETTO - PIEDE IN MASSELLO DI NOCE CANALETTO

WOODEN BED SURROUND IN BLOCKBOARD PANEL COVERED IN CANALETTO WALNUT - FOOT IN SOLID CANALETTO WALNUT

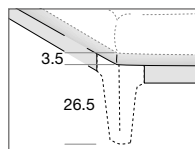

GIROLETTO LEGNO E IMBOTTITO IN PANNELLO DI LISTELLARE NOCE CANALETTO E IMBOTTITO IN GOMMAPIUMA E RIVESTITO CON TESSUTI DA CAMPIONARIO - PIEDE IN MASSELLO DI NOCE CANALETTO

WOODEN BED SURROUND AND UPHOLSTERED IN CANALETTO WALNUT BLOCKBOARD PANEL AND UPHOLSTERED IN FOAM RUBBER AND COVERED WITH SAMPLE FABRICS - FOOT IN SOLID CANALETTO WALNUT

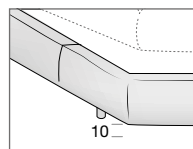

GIROLETTO IMBOTTITO STRUTTURA IN MULTISTRATO DI PIOPPO, IMBOTTITO IN GOMMAPIUMA E RIVESTITO CON TESSUTI DA CAMPIONARIO

UPHOLSTERED BED SURROUND WITH STRUCTURE IN POPLAR MULTILAYER, UPHOLSTERED IN FOAM RUBBER AND COVERED WITH SAMPLE FABRICS

RAINBOW

VERSIONE PANNELLO IMBOTTITO, NON SFODERABILE

**TESTIERA** PANNELLO MULTISTRATO PIOPPO IMBOTTITO IN GOMMAPIUMA E RIVESTITO CON TESSUTI DA CAMPIONARIO, PIEDE POSTERIORE COME IL PIEDE ANTERIORE

VERSION WITH UPHOLSTERED PANEL, WITHOUT REMOVABLE COVER

**HEADBOARD** POPLAR MULTILAYER PANEL UPHOLSTERED WITH FOAM RUBBER AND COVERED WITH SAMPLE FABRICS, REAR FEET THE SAME AS FRONT FEET.

VERSIONE PANNELLO IMBOTTITO CON CUCITURA BARRÈ, NON SFODERABILE

**TESTIERA** PANNELLO MULTISTRATO PIOPPO IMBOTTITO IN GOMMAPIUMA, RIVESTITO CON TESSUTI DA CAMPIONARIO E TRAPUNTATO. PIEDE POSTERIORE COME IL PIEDE ANTERIORE

VERSION WITH UPHOLSTERED PANEL WITH BARRÈ SEAM, WITHOUT REMOVABLE COVER

**HEADBOARD** POPLAR MULTILAYER PANEL UPHOLSTERED WITH FOAM RUBBER AND COVERED WITH SAMPLE FABRICS AND QUILTED. REAR FEET THE SAME AS FRONT FEET.

DIMENSIONI TESTIERE

HEADBOARD DIMENSIONS

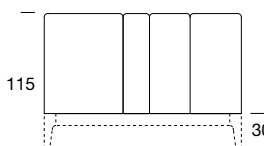

### ARMADI ANTE SCORREVOLI E BATTENTI SLIDING DOOR AND HINGED DOOR WARDROBES

#### SCocca DI SERIE

<b>CAPPELLO, FONDO E FIANCO DIVISORIO</b>	PANNELLO DI PARTICELLE DI LEGNO IMPIALLACCIATO 2 LATI IN DECORATIVO "OLMO SBIANCATO" SP. 2,5 CM
<b>FIANCO ESTERNO</b>	PANNELLO IN LEGNO CON TELAIO IN ABETE DI SP. CM. 3 IMPIALLACCIATO ESTERNAMENTE IN NOCE TANGANICA VERNICIATO ED INTERNAMENTE IN DECORATIVO "OLMO SBIANCATO"
<b>RIPIANO</b>	PANNELLO DI PARTICELLE DI LEGNO IMPIALLACCIATO 2 LATI IN DECORATIVO "OLMO SBIANCATO" SP. 2,5 CM E BORDO FRONTALE SP. 3,6 CM
<b>SCHIENALE</b>	PANNELLO DI MDF IMPIALLACCIATO IN DECORATIVO "OLMO SBIANCATO" SP. CM.0,6
<b>CASSETTIERA</b>	FONDO E FIANCHI IN PANNELLO DECORATIVO, FRONTALE E STRUTTURA CASSETTI IN PARTICELLE DI LEGNO, FRONTALE CASSETTO IN PANNELLO DECORATIVO. I CASSETTI SCORRONO SU GUIDE A SCOMPARSA AD ESTRAZIONE PARZIALE. RIPIANO COPRI CASSETTIERA IN PANNELLO DI PARTICELLE DI LEGNO IMPIALLACCIATO IN DECORATIVO SP. CM.4

#### STANDARD STRUCTURE

<b>TOP AND BOTTOM PANEL</b>	PANEL OF WOOD PARTICLES VENEERED 2 SIDES IN DECORATIVE "OLMO SBIANCATO" TH. 2.5 CM
<b>OUTSIDE SIDE PANEL</b>	WOODEN PANEL WITH FIR FRAME TH. CM. 3, OUTSIDE VENEERED IN PAINTED TANGANICA WALNUT AND INSIDE IN DECORATIVE.
<b>SHELF</b>	PANEL OF WOOD PARTICLES COVERED ON 2 SIDES IN DECORATIVE "OLMO SBIANCATO" TH. 2.5 CM AND FRONT EDGE TH. 3.6 CM
<b>BACK PANEL</b>	VENEERED MDF PANEL IN "OLMO SBIANCATO" DECORATIVE THICKNESS. CM.0,6
<b>DRAWER UNIT</b>	BOTTOM AND SIDE IN DECORATIVE PANEL TH. CM. 1.8, DRAWER STRUCTURE AND FRONT WOOD PARTICLE, DRAWER FRONT IN DECORATIVE PANEL TH. CM. 1.8. DRAWERS RUN ON PARTIAL EXTRACTION CONCEALED GUIDES. DRAWER UNIT SHELF IN WOOD PARTICLE BOARD PANEL VENEERED IN DECORATIVE TH. CM.1,9. FRONT EDGE TH. CM 3,6 .

#### HOLA | BATTENTE - HINGED DOORS

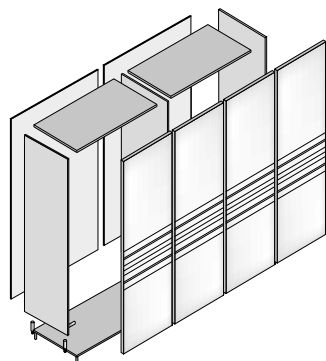

**VERSIONE 4 ANTE BATTENTE**  
VERSION WITH 4 HINGED DOOR

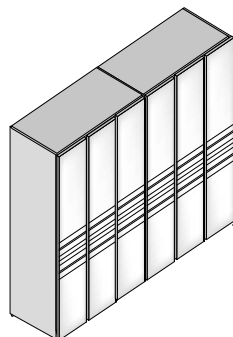

**VERSIONE 6 ANTE BATTENTE**  
VERSION WITH 6 HINGED DOOR

#### ARMADIO HOLA 4 e 6 ANTE BATTENTI

<b>ANTE</b>	PANNELLO IN LEGNO CON TELAIO IN ABETE E COPERTINE IN MDF IMPIALLACCIATO NOCE CANALETTO.
<b>DECORO ORIZZONTALE</b>	LISTELLI DI MASSELLO DI NOCE CANALETTO VERNICIATO.
<b>APERTURA</b>	MANIGLIA IN MASSELLO DI NOCE CANALETTO.
<b>OPTIONALS</b>	FASCIA DECORATA: VETRO DI VARIE DECORAZIONI (SILVER, GOLD, SAHARA NOIRE, KALACATTA O SPECCHIO FUMÉ) SP. 3MM

#### HOLA 4 AND 6 HINGED DOORS WARDROBE

<b>DOORS</b>	WOODEN PANEL WITH FIR FRAME AND COVERS IN CANALETTO WALNUT VENEERED MDF.
<b>HORIZONTAL DECORATION</b>	SOLID STRIPS IN CANALETTO WALNUT
<b>OPENING</b>	HANDLE IN SOLID CANALETTO WALNUT
<b>OPTIONALS</b>	DECORATED BAND: GLASS OF VARIOUS DECORATIONS (SILVER, GOLD, SAHARA NOIRE, KALACATTA OR SMOKED MIRROR ) SP. 3MM

#### HOLA | SCORREVOLE - SLIDING DOORS

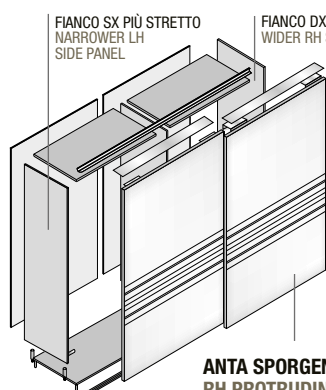

**VERSIONE 2 ANTE LEGNO**  
VERSION WITH 2 WOODEN DOOR

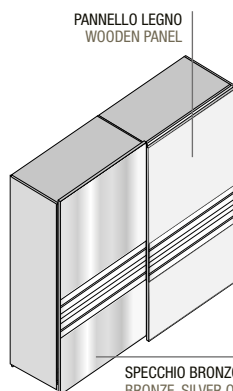

**VERSIONE 1 ANTA SPECCHIO, 1 ANTA LEGNO**  
VERSION WITH 1 WOODEN AND 1 MIRROR DOOR

#### ARMADIO HOLA 2 ANTE SCORREVOLI CON O SENZA SPECCHI

<b>ANTE</b>	PANNELLO FRONTALE DI MULTISTRATI IMPIALLACCIATO NOCE CANALETTO SP. 0,8 CM E STRUTTURA IN PROFILATI DI ALLUMINIO CON RADDRIZZANTI INTEGRATI
<b>DECORO ORIZZONTALE</b>	LISTELLI DI MASSELLO DI NOCE CANALETTO VERNICIATO.
<b>APERTURA</b>	MANIGLIA LATERALE IN ZAMA VERNICICATO NICKEL LUCIDO O BRONZO.
<b>OPTIONALS</b>	FASCIA DECORATA: VETRO DI VARIE DECORAZIONI (SILVER, GOLD, SAHARA NOIRE, KALACATTA O SPECCHIO FUMÉ) SP. 3MM

#### HOLA WARDROBE 2 SLIDING DOORS WITH OR WITHOUT MIRRORS

<b>DOORS</b>	FRONT PANEL IN CANALETTO WALNUT VENEERED MULTILAYER SP. 0,8 CM AND STRUCTURE MADE OF ALUMINUM PROFILES WITH INTEGRATED STRAIGHTENERS
<b>HORIZONTAL DECORATION</b>	SOLID STRIPS IN CANALETTO WALNUT
<b>OPENING</b>	LATERAL HANDLE IN ZAMAK PAINTED POLISHED NICKEL OR BRONZE.
<b>OPTIONALS</b>	DECORATED BAND: GLASS OF VARIOUS DECORATIONS (SILVER, GOLD, SAHARA NOIRE, KALACATTA OR SMOKED MIRROR ) SP. 3MM

#### JAZZ

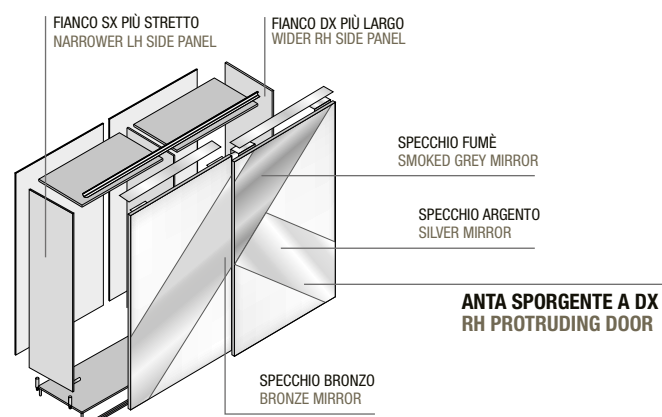

**ANTA SPORGENTE A DX**  
RH PROTRUDING DOOR

#### ARMADIO JAZZ 2 ANTE SCORREVOLI

<b>ANTE</b>	PANNELLO FRONTALE DI MULTISTRATI IMPIALLACCIATO NOCE CANALETTO SP. 0,8 CM E STRUTTURA IN PROFILATI DI ALLUMINIO CON RADDRIZZANTI INTEGRATI VERNICIATO. SPECCHIO ARGENTO, BRONZO E FUMÉ.
<b>APERTURA</b>	MANIGLIA LATERALE IN ZAMA VERNICICATO NICKEL LUCIDO O BRONZO.

#### JAZZ WARDROBE WITH 2 SLIDING DOORS

<b>DOORS</b>	FRONT PANEL OF MULTILAYERS VENEERED IN CANALETTO WALNUT SP. 0.8 CM AND PAINTED ALUMINUM PROFILES STRUCTURE WITH INTEGRATED STRAIGHTENERS. SILVER, BRONZE AND SMOKE MIRROR.
<b>OPENING</b>	LATERAL HANDLE IN ZAMAK PAINTED POLISHED NICKEL OR BRONZE.

CARATTERISTICHE TECNICHE  
TECHNICAL CHARACTERISTICS

**VERSIONE CON 2 SPECCHI E DOGA LEGNO**  
**VERSION WITH 2 MIRRORS AND WOODEN SLAT**

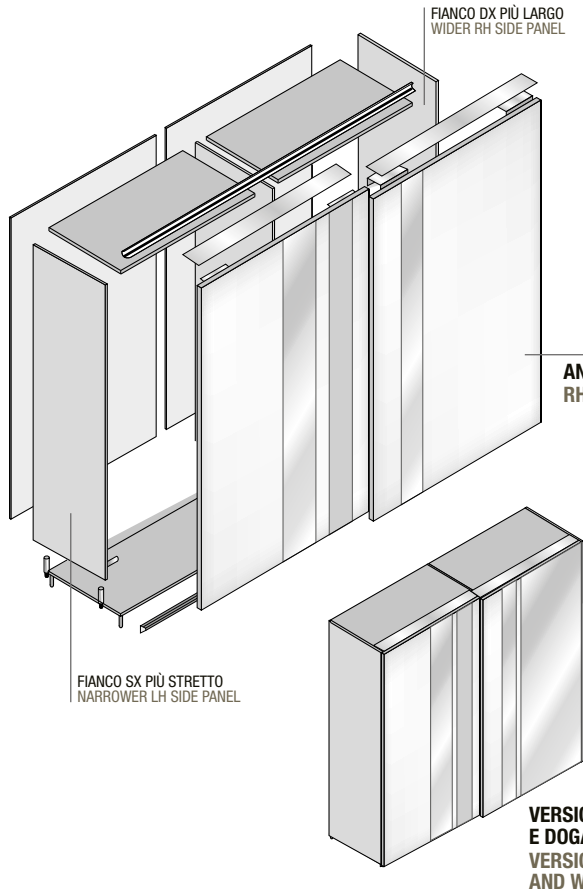

DOMINO

**ARMADIO DOMINO 2 ANTE SCORREVOLI**

**ANTE** PANNELLO FRONTALE DI MULTISTRATI IMPIALLACCIATO NOCE CANALETTO SP. CM 0,8 E STRUTTURA IN PROFILATI DI ALLUMINIO CON RADDRIZZANTI INTEGRATI. DOGHE LEGNO LISCIO, RIGHE O LEGNO QUADRO IN PANNELLO DI MULTISTRATI IMPIALLACCIATO NOCE CANALETTO, VERNICIATO. MANIGLIA LATERALE IN ZAMA NICHEL LUCIDO O BRONZO. SPECCHIO BRONZO O ARGENTO

**APERTURA** MANIGLIA LATERALE IN ZAMA VERNICATO NICKEL LUCIDO O BRONZO.

**DOMINO WARDROBE WITH 2 SLIDING DOORS**

**DOORS** FRONT PANEL IN MULTILAYER WITH CANALETTO WALNUT VENEER TH. CM 0.8 E STRUCTURE MADE OF ALUMINUM PROFILES WITH INTEGRATED STRAIGHTENERS. PLAIN WOODEN SLATS, STRIPED OR SQUARE WOOD IN MULTILAYER PANEL VENEERED IN CANALETTO WALNUT, PAINTED. LATERAL HANDLE IN ZAMA NICKEL GLOSSY OR BRONZE. BRONZE NAD SILVER MIRROR

**OPENING** LATERAL HANDLE IN ZAMAK PAINTED POLISHED NICKEL OR BRONZE.

**VERSIONE CON 2 SPECCHI**  
**VERSION WITH 2 MIRRORS**

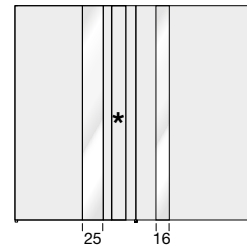

**VERSIONE CON 3 SPECCHI**  
**VERSION WITH 3 MIRRORS**

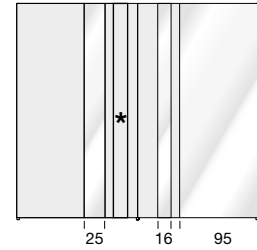

**N.B.: NELLA DOGA QUADRO VERTICALE IL DECORO NON SI PRESENTA IN TUTTA LUNGHEZZA MA SOLO NELLA METÀ INFERIORE DELL'ANTA**  
**N.B.: DECORATION ON THE VERTICAL SQUARE SLAT COVERS JUST THE BOTTOM HALF OF THE DOOR, NOT THE ENTIRE LENGTH.**

SWING

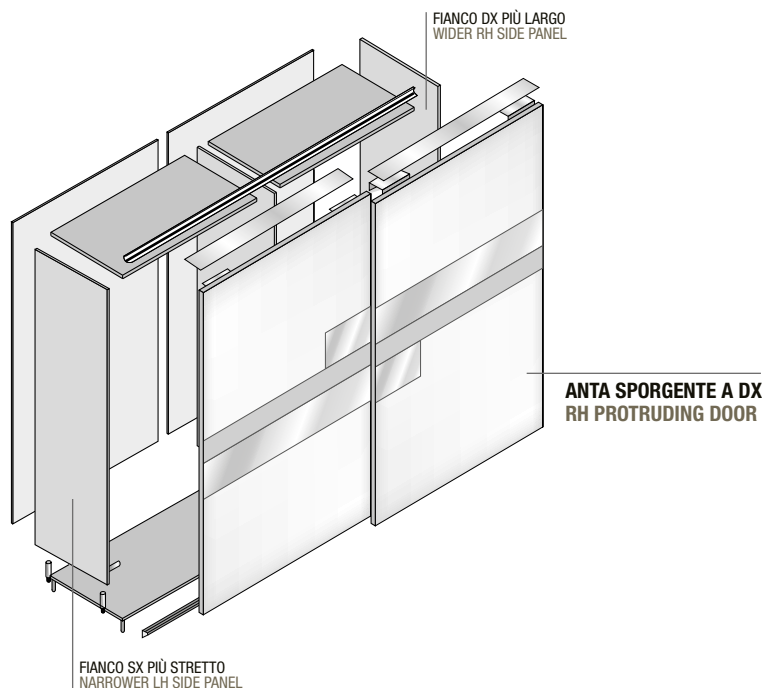

**ARMADIO SWING 2 ANTE SCORREVOLI**

**ANTE SWING** PANNELLO FRONTALE DI MULTISTRATI IMPIALLACCIATO NOCE CANALETTO SP. CM 0,8 E STRUTTURA IN PROFILATI DI ALLUMINIO CON RADDRIZZANTI INTEGRATI. DOGHE LEGNO LISCIO, RIGHE O LEGNO QUADRO IN PANNELLO DI MULTISTRATI IMPIALLACCIATO NOCE CANALETTO, VERNICIATO. SPECCHIO BRONZO O ARGENTO

**APERTURA** MANIGLIA LATERALE IN ZAMA VERNICATO NICKEL LUCIDO O BRONZO.

**SWING WARDROBE WITH 2 SLIDING DOORS**

**SWING DOORS** FRONT PANEL IN MULTILAYER WITH CANALETTO WALNUT VENEER TH. CM 0.8 E STRUCTURE MADE OF ALUMINUM PROFILES WITH INTEGRATED STRAIGHTENERS. PLAIN WOODEN SLATS, STRIPED OR SQUARE WOOD IN MULTILAYER PANEL VENEERED IN CANALETTO WALNUT, PAINTED. BRONZE NAD SILVER MIRROR

**OPENING** LATERAL HANDLE IN ZAMAK PAINTED POLISHED NICKEL OR BRONZE.

**DOGA ORIZZONTALE**  
**HORIZONTAL SLAT**

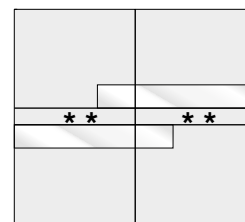

**N.B.: NELLA DOGA QUADRO ORIZZONTALE IL DECORO SI PRESENTA AL CENTRO E FINISCE AI LATI CON RIGHE CONTINUE**  
**N.B.: DECORATION ON THE HORIZONTAL SQUARE SLAT IS IN THE MIDDLE AND FINISHES ON SIDES WITH CONTINUOUS STRIPES**

### ARMADI WARDROBES

#### FERRAMENTA PER ARMADI SCORREVOLI HARDWARE FOR SLIDING WARDROBES

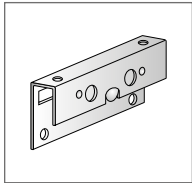

PATTINO SUPERIORE PER ANTA INTERNA  
TOP RUNNER FOR INTERNAL DOOR

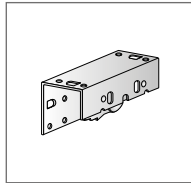

CARRELLO SUPERIORE ANTA  
DOOR TOP RUNNER

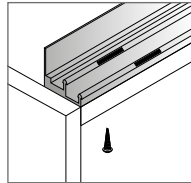

BINARIO SUPERIORE  
TOP TRACK

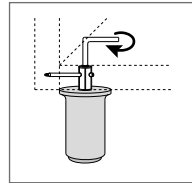

PIEDE REGOLATORE  
ADJUSTABLE FOOT

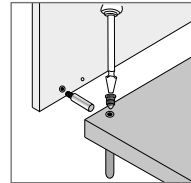

MONTAGGIO PIEDE REGOLATORE  
ADJUSTABLE FOOT ASSEMBLY

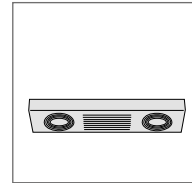

DEPURATORE D'ARIA CON SISTEMA AIRLIGHTPRO UV-A (OPTIONAL)  
AIR PURIFIER WITH UV-A AIRLIGHTPRO SYSTEM



BARRA LED IN ALLUMINIO CON LUCE CALDA (OPTIONAL)  
ALUMINUM LED BAR WITH WARM LIGHT (OPTIONAL)

#### VANI INTERNI - ARMADI 2 ANTE SCORREVOLI E 4 ANTE BATTENTE INTERNAL COMPARTMENT - 2 SLIDING DOOR AND 4 HINGED DOOR WARDROBES

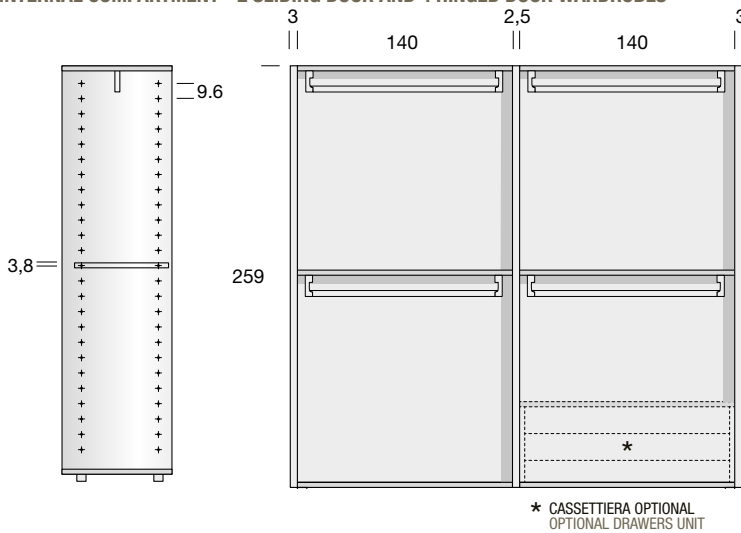

#### VANI INTERNI ARMADIO 6 ANTE BATTENTE INTERNAL COMPARTMENT FOR 6 HINGED DOORS

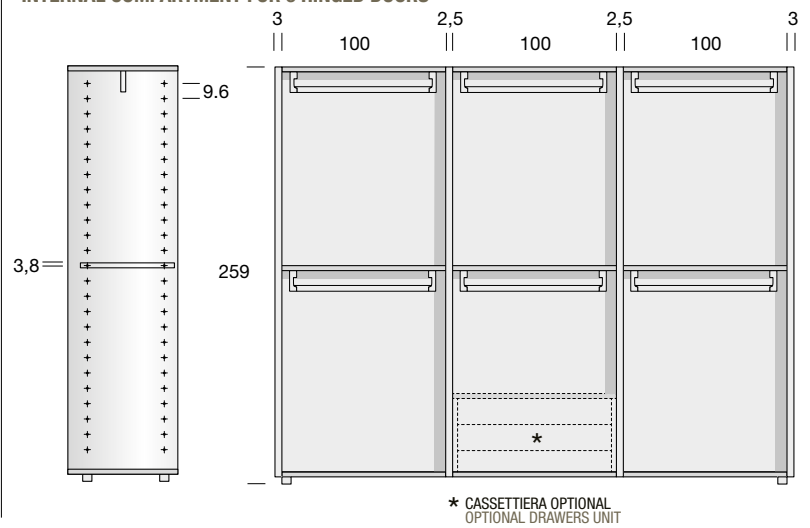

#### REGOLAZIONE ANTE SCORREVOLI PRIMA DEL MONTAGGIO SLIDING DOOR ADJUSTMENT BEFORE ASSEMBLY

PRIMA DI PROCEDERE AL MONTAGGIO, BISOGNA REGOLARE LA TENSIONE DELLE ANTE POSIZIONANDOLE OBBLIGATORIAMENTE IN ORIZZONTALE E UTILIZZANDO UN CACCIAVITE O UN PUNTERUOLO.

BEFORE ASSEMBLING REGULATE DOOR TENSION BY PLACING THEM HORIZONTALLY AND USING THE SPECIAL SPANNER PROVIDED.

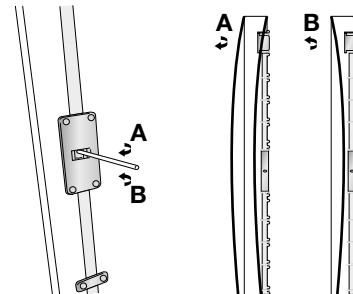

#### MONTAGGIO ANTE SCORREVOLI SLIDING DOOR ASSEMBLY

PER POTER AGGANCIARE LE ANTE AL BINARIO SUPERIORE TRA IL SOFFITTO E L'ARMADIO CI DEVONO ESSERE ALMENO 3 CM.

LEAVE AT LEAST 3CM CLEARANCE SO THAT THE DOORS CAN BE ATTACHED TO THE UPPER RAIL BETWEEN THE CEILING AND WARDROBE.

- 1 AGGANCIARE L'ANTA AL BINARIO SUPERIORE  
FASTEN THE DOOR TO THE TOP TRACK
- 2 SPINGERE L'ANTA NEL BINARIO INFERIORE  
PUSH THE DOOR IN THE LOW TRACK

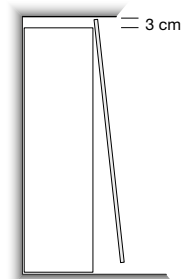
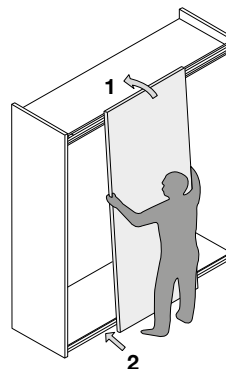

#### SMONTAGGIO ANTE SCORREVOLI REMOVAL SLIDING DOORS

PER SBLOCCARE LE ANTE DAL SISTEMA DI BLOCCAGGIO DI SICUREZZA È NECESSARIO AVVITARE IL GRANO (1), LA LINGUETTA (2) SI SPOSTA AUTOMATICAMENTE E SARÀ POSSIBILE SGANCIARE LE ANTE.

TO RELEASE THE DOORS FROM THE SAFETY LOCKING SYSTEM YOU NEED TO TIGHTEN THE SPECIAL SCREW(1), THE TAB (2) AUTOMATICALLY MOVES AND THE DOORS CAN BE RELEASED

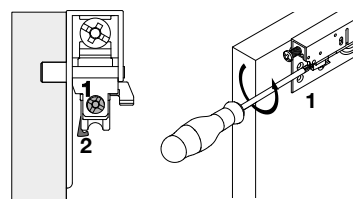



CARATTERISTICHE TECNICHE  
TECHNICAL CHARACTERISTICS

**DIVANO COMPONENTE PENTA**  
**PENTA MODULAR SOFA**

**BASI A TERRA H. 45**  
FLOOR BASES H. 45

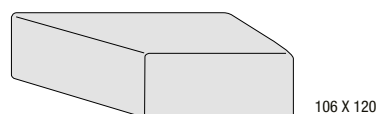
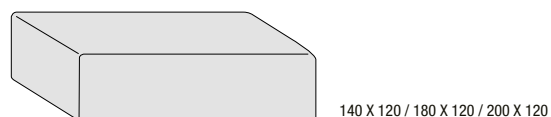
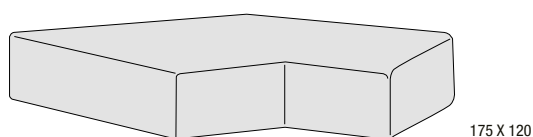
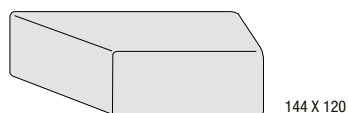
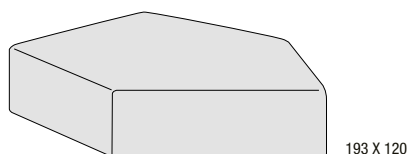

**BASI A TERRA**

**BASE** PANNELLO DI MULTISTRATO DI PIOPPO, CON POLIURETANO ESPANSO EET/21, MEMORY, DRACOM DOUPHON, TELA DI COTONE E RIVESTIMENTO DA CAPIONARIO.

**FLOOR BASES**

**BASE** BASE: POPLAR PLYWOOD PANEL, WITH EET/21 EXPANDED POLYURETHANE, MEMORY, DRACOM DOUPHON, CANVAS COTTON AND CAPIONARY COVERING.

**PENTA**

**SCHIENALI MOBILI H. 25**  
MOVABLE BACKREST H. 25

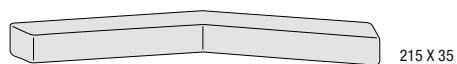
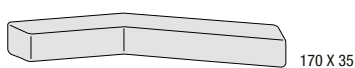

**SCHIENALI MOBILI**

**BASE** STECCA IN METALLO, POLIURETANO ESPANSO PF/35, MEMORY, DRACOM DOUPHON E RIVESTIMENTO DA CAPIONARIO.

**MOVABLE BACKREST**

**BASE** METAL SPINE, PF/35 EXPANDED POLYURETHANE, MEMORY, DRACOM DOUPHON AND CAPIONARY COVERING.

**TAVOLINO PENTA**  
PENTA COFFEE TABLE

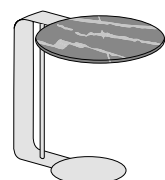

**TAVOLINO PENTA**

**STRUTTURA** METALLO VERNICIATO

**PIANO** CERAMICA 3D SPES. 1,2 CM

**PENTA COFFEE TABLE**

**STRUCTURE** PAINTED METAL

**TOP** FULL BODY CERAMIC TICK 1,2 CM

## CREDENZE SIDEBOARDS

### CREDENZA OPERA OPERA SIDEBOARD

**NEW**

3 ANTE LEGNO, 3 RIPIANI VETRO  
GAMBE VETRO  
3 WOODEN DOORS, 3 GLASS SHELVES  
GLASS LEGS

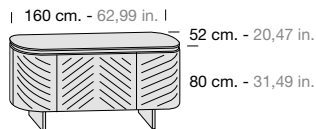

RIPIANI LEGNO AL POSTO DI VETRO WOODEN SHELVES INSTEAD OF GLASS SHELVES + 99	<b>DEG2361K</b>	<b>OPTIONAL</b>		
		<b>ACS7228C</b> TOP CERAMICA CERAMIC TOP	<b>ACS7112C</b> LUCE LED INTERNA INTERNAL LED LIGHT	<b>ACS7012C</b> LUCE LED PER BASE LED LIGHT FOR BASE
<b>CANALETTO</b>	<b>3.980</b>	<b>+ 700</b>	<b>+ 475</b>	<b>+ 200</b>
mc 0,79 – Kg 90				

### CREDENZA OPERA OPERA SIDEBOARD

4 ANTE LEGNO, 4 RIPIANI VETRO  
GAMBE VETRO  
4 WOODEN DOORS, 4 GLASS SHELVES  
GLASS LEGS

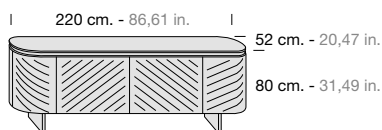

RIPIANI LEGNO AL POSTO DI VETRO WOODEN SHELVES INSTEAD OF GLASS SHELVES + 99	<b>DEG2351K</b>	<b>OPTIONAL</b>		
		<b>ACS7218C</b> TOP CERAMICA CERAMIC TOP	<b>ACS7112C</b> LUCE LED INTERNA INTERNAL LED LIGHT	<b>ACS7012C</b> LUCE LED PER BASE LED LIGHT FOR BASE
<b>CANALETTO</b>	<b>4.900</b>	<b>+ 900</b>	<b>+ 475</b>	<b>+ 200</b>
mc 1,10 – Kg 95				

### CREDENZA OPERA OPERA SIDEBOARD

**NEW**

3 ANTE LEGNO, 3 RIPIANI VETRO  
GAMBE METALLO  
3 WOODEN DOORS, 3 GLASS SHELVES  
METAL LEGS

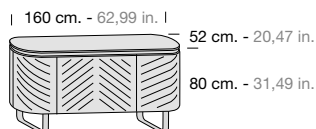

RIPIANI LEGNO AL POSTO DI VETRO WOODEN SHELVES INSTEAD OF GLASS SHELVES + 99	<b>DEG2381K</b>	<b>OPTIONAL</b>		
		<b>ACS7228C</b> TOP CERAMICA CERAMIC TOP	<b>ACS7112C</b> LUCE LED INTERNA INTERNAL LED LIGHT	<b>ACS7012C</b> LUCE LED PER BASE LED LIGHT FOR BASE
<b>CANALETTO</b>	<b>4.200</b>	<b>+ 700</b>	<b>+ 475</b>	<b>+ 200</b>
mc 0,79 – Kg 90				

### CREDENZA OPERA OPERA SIDEBOARD

**NEW**

4 ANTE LEGNO, 4 RIPIANI VETRO  
GAMBE METALLO  
4 WOODEN DOORS, 4 GLASS SHELVES  
METAL LEGS

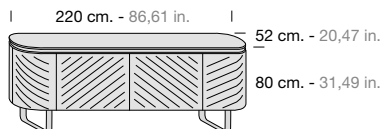

RIPIANI LEGNO AL POSTO DI VETRO WOODEN SHELVES INSTEAD OF GLASS SHELVES + 99	<b>DEG2371K</b>	<b>OPTIONAL</b>		
		<b>ACS7218C</b> TOP CERAMICA CERAMIC TOP	<b>ACS7112C</b> LUCE LED INTERNA INTERNAL LED LIGHT	<b>ACS7012C</b> LUCE LED PER BASE LED LIGHT FOR BASE
<b>CANALETTO</b>	<b>5.100</b>	<b>+ 900</b>	<b>+ 475</b>	<b>+ 200</b>
mc 1,10 – Kg 95				

### CREDENZA YORK H. 70 YORK SIDEBOARD H. 70

3 ANTE LEGNO, 3 RIPIANI VETRO  
GAMBE METALLO  
3 WOODEN DOORS, 3 GLASS SHELVES  
METAL LEGS

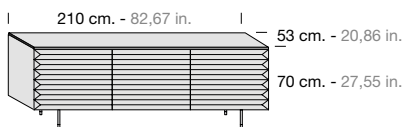

RIPIANI LEGNO AL POSTO DI VETRO WOODEN SHELVES INSTEAD OF GLASS SHELVES + 99	<b>DEG2001K</b>	<b>OPTIONAL</b>		
	ANTE LEGNO WOODEN DOORS	<b>ACS7219C</b> TOP CERAMICA CERAMIC TOP	<b>ACS7001C</b> LUCE LED INTERNA INTERNAL LED LIGHT	
<b>CANALETTO</b>	<b>3.900</b>	<b>+ 950</b>	<b>+ 500</b>	
mc 0,95 – Kg 95		mc 0,95 – Kg 95		

#### MAGGIORAZIONI E RIDUZIONI SURCHARGES AND REDUCTIONS

##### RIDUZIONI SINGOLE SINGLE ADJUSTMENTS

LUNGHEZZA LENGTH	
PROFONDITÀ DEPTH	+ 30%
ALTEZZA HEIGHT	

##### RIDUZIONI COMBinate TRA LORO COMBINED ADJUSTMENTS

LUNGHEZZA + PROFONDITÀ LENGTH + DEPTH	+ 40%
--	-------

PER ULTERIORI MODIFICHE  
RICHIEDERE PREVENTIVO  
FOR MODIFICATIONS  
ASK FOR AN ESTIMATE.

**CREDENZE  
SIDEBOARDS**

**CREDENZA YORK H. 80  
YORK SIDEBOARD H. 80**

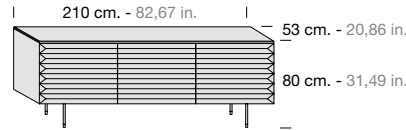

3 ANTE LEGNO, 3 RIPIANI VETRO  
GAMBE METALLO  
3 WOODEN DOORS, 3 GLASS SHELVES  
METAL LEGS

RIPIANI LEGNO AL POSTO DI VETRO  
WOODEN SHELVES INSTEAD OF GLASS SHELVES + 99

CANALETTO

DEG2011K	OPTIONAL		
ANTE LEGNO WOODEN DOORS	ACS7219C TOP CERAMICA CERAMIC TOP	ACS7001C LUCE LED INTERNA INTERNAL LED LIGHT	
<b>3.900</b>	<b>+ 950</b>	<b>+ 500</b>	
mc 1,06 – Kg 96	mc 1,06 – Kg 96		

**CREDENZA YORK H. 70  
YORK SIDEBOARD H. 70**

**NEW**

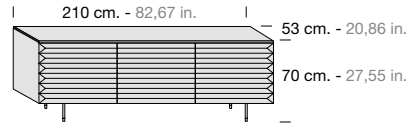

3 ANTE LEGNO, 3 RIPIANI VETRO  
GAMBE METALLO  
3 WOODEN DOORS, 3 GLASS SHELVES  
METAL LEGS

RIPIANI LEGNO AL POSTO DI VETRO  
WOODEN SHELVES INSTEAD OF GLASS SHELVES + 99

CANALETTO

DEG2121K	DEG2221K	OPTIONAL	
SOLO ANTE EFFETTO METALLO BRONZO/GRAFITE ONLY DOORS BRONZO/GRAFITE METAL EFFECT	STRUTTURA E ANTE EFFETTO METALLO BRONZO/GRAFITE STRUCTURE AND DOORS BRONZO/GRAFITE METAL EFFECT	ACS7219C TOP CERAMICA CERAMIC TOP	ACS7001C LUCE LED INTERNA INTERNAL LED LIGHT
<b>4.400</b>	<b>5.400</b>	<b>+ 950</b>	<b>+ 500</b>
mc 0,95 – Kg 95	mc 0,80 – Kg 95		

**CREDENZA YORK H. 80  
YORK SIDEBOARD H. 80**

**NEW**

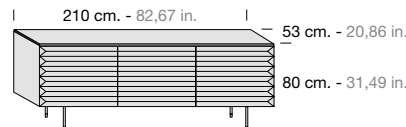

3 ANTE LEGNO, 3 RIPIANI VETRO  
GAMBE METALLO  
3 WOODEN DOORS, 3 GLASS SHELVES  
METAL LEGS

RIPIANI LEGNO AL POSTO DI VETRO  
WOODEN SHELVES INSTEAD OF GLASS SHELVES + 99

CANALETTO

DEG2131K	DEG2231K	OPTIONAL	
SOLO ANTE EFFETTO METALLO BRONZO/GRAFITE ONLY DOORS BRONZO/GRAFITE METAL EFFECT	STRUTTURA E ANTE EFFETTO METALLO BRONZO/GRAFITE STRUCTURE AND DOORS BRONZO/GRAFITE METAL EFFECT	ACS7219C TOP CERAMICA CERAMIC TOP	ACS7001C LUCE LED INTERNA INTERNAL LED LIGHT
<b>4.400</b>	<b>5.400</b>	<b>+ 950</b>	<b>+ 500</b>
mc 1,06 – Kg 96	mc 1,06 – Kg 96		

**CREDENZA BOOK H. 73  
BOOK SIDEBOARD H. 73**

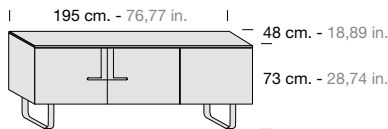

2 ANTE CON MANIGLIA, 1 ANTA LISCIA  
2 RIPIANI VETRO, GAMBE METALLO  
2 DOORS WITH HANDLES, 1 SMOOTH DOOR,  
2 GLASS SHELVES, METAL LEGS

SPECIFICARE IL METALLO GAMBE,  
BRONZO O GRAFITE  
TO SPECIFY, BRONZE OR ANTHRACITE  
METAL FEET

RIPIANI LEGNO AL POSTO DI VETRO  
WOODEN SHELVES INSTEAD OF GLASS SHELVES + 240

CANALETTO

CUG2001K	OPTIONAL		
	ACS7222C TOP CERAMICA CERAMIC TOP		
<b>4.100</b>	<b>+ 900</b>		
mc 0,81 – Kg 90			

**CREDENZA BOOK H. 73  
BOOK SIDEBOARD H. 73**

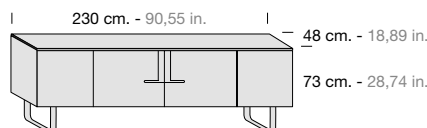

2 ANTE CON MANIGLIA, 2 ANTE LISCE  
3 RIPIANI VETRO, GAMBE METALLO  
2 DOORS WITH HANDLES, 2 SMOOTH DOORS,  
2 GLASS SHELVES, METAL LEGS

SPECIFICARE IL METALLO GAMBE,  
BRONZO O GRAFITE  
TO SPECIFY, BRONZE OR ANTHRACITE  
METAL FEET

RIPIANI LEGNO AL POSTO DI VETRO  
WOODEN SHELVES INSTEAD OF GLASS SHELVES + 320

CANALETTO

CUG2011K	OPTIONAL		
	ACS7322C TOP CERAMICA CERAMIC TOP		
<b>4.750</b>	<b>+ 1.050</b>		
mc 0,96 – Kg 100			

**MAGGIORAZIONI E RIDUZIONI  
SURCHARGES AND REDUCTIONS**

RIDUZIONI SINGOLE  
SINGLE ADJUSTMENTS

LUNGHEZZA LENGTH	
PROFONDITA DEPTH	+ 30%
ALTEZZA HEIGHT	

RIDUZIONI COMBinate TRA LORO  
COMBINED ADJUSTMENTS

LUNGHEZZA + PROFONDITA LENGTH + DEPTH	+ 40%
--	-------

PER ULTERIORI MODIFICHE  
RICHIEDERE PREVENTIVO  
FOR MODIFICATIONS  
ASK FOR AN ESTIMATE.

## CREDENZE SIDEBOARDS

### CREDENZA BOOK FLUTTUANTE H. 73 BOOK FLOATING SIDEBOARD H. 73

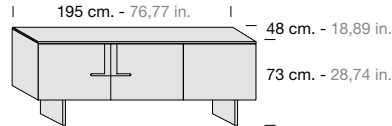

2 ANTE CON MANIGLIA, 1 ANTA LISCIA  
2 RIPIANI VETRO, GAMBE VETRO  
2 DOORS WITH HANDLES, 1 SMOOTH DOOR,  
2 GLASS SHELVES, GLASS LEGS

RIPIANI LEGNO AL POSTO DI VETRO  
WOODEN SHELVES INSTEAD OF GLASS SHELVES + 240

	CUG2041K	OPTIONAL	
		ACS7222C	
		GAMBE VETRO FUMÉ SMOKED GLASS LEGS	TOP CERAMICA CERAMIC TOP
CANALETTO	3.900	+ 300	+ 900
	mc 0,81 – Kg 95		

### CREDENZA BOOK FLUTTUANTE H. 73 BOOK FLOATING SIDEBOARD H. 73

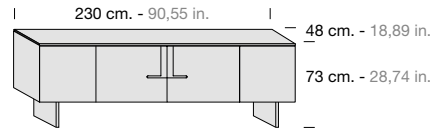

2 ANTE CON MANIGLIA, 2 ANTE LISCE  
2 RIPIANI VETRO, GAMBE VETRO  
2 DOORS WITH HANDLES, 2 SMOOTH DOORS,  
2 GLASS SHELVES, GLASS LEGS

RIPIANI LEGNO AL POSTO DI VETRO  
WOODEN SHELVES INSTEAD OF GLASS SHELVES + 320

	CUG2051K	OPTIONAL	
		ACS7322C	
		GAMBE VETRO FUMÉ SMOKED GLASS LEGS	TOP CERAMICA CERAMIC TOP
CANALETTO	4.550	+ 300	+ 1.050
	mc 0,96 – Kg 105		

### CREDENZA BOOK H. 83 BOOK SIDEBOARD H. 83

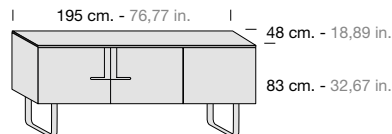

2 ANTE CON MANIGLIA, 1 ANTA LISCIA  
2 RIPIANI VETRO, GAMBE METALLO  
2 DOORS WITH HANDLES, 1 SMOOTH DOOR,  
2 GLASS SHELVES, METAL LEGS

RIPIANI LEGNO AL POSTO DI VETRO  
WOODEN SHELVES INSTEAD OF GLASS SHELVES + 240

SPECIFICARE IL METALLO GAMBE,  
BRONZO O GRAFITE  
TO SPECIFY, BRONZE OR ANTHRACITE  
METAL FEET

	CUG2101K	OPTIONAL	
		ACS7222C	
		TOP CERAMICA CERAMIC TOP	
CANALETTO	4.400	+ 900	
	mc 0,93 – Kg 92		

### CREDENZA BOOK H. 83 BOOK SIDEBOARD H. 83

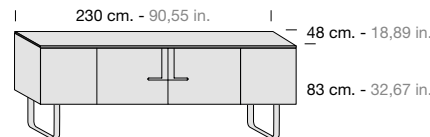

2 ANTE CON MANIGLIA, 2 ANTE LISCE  
3 RIPIANI VETRO, GAMBE METALLO  
2 DOORS WITH HANDLES, 2 SMOOTH DOORS,  
2 GLASS SHELVES, METAL LEGS

RIPIANI LEGNO AL POSTO DI VETRO  
WOODEN SHELVES INSTEAD OF GLASS SHELVES + 320

SPECIFICARE IL METALLO GAMBE,  
BRONZO O GRAFITE  
TO SPECIFY, BRONZE OR ANTHRACITE  
METAL FEET

	CUG2111K	OPTIONAL	
		ACS7322C	
		TOP CERAMICA CERAMIC TOP	
CANALETTO	4.900	+ 1.050	
	mc 1,10 – Kg 102		

### CREDENZA BOOK FLUTTUANTE H. 83 BOOK FLOATING SIDEBOARD H. 83

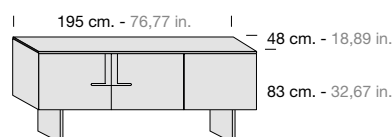

2 ANTE CON MANIGLIA, 1 ANTA LISCIA  
2 RIPIANI VETRO, GAMBE VETRO  
2 DOORS WITH HANDLES, 1 SMOOTH DOOR,  
2 GLASS SHELVES, GLASS LEGS

RIPIANI LEGNO AL POSTO DI VETRO  
WOODEN SHELVES INSTEAD OF GLASS SHELVES + 240

	CUG2141K	OPTIONAL	
		ACS7222C	
		GAMBE VETRO FUMÉ SMOKED GLASS LEGS	TOP CERAMICA CERAMIC TOP
CANALETTO	4.200	+ 300	+ 900
	mc 0,93 – Kg 97		

#### MAGGIORAZIONI E RIDUZIONI SURCHARGES AND REDUCTIONS

##### RIDUZIONI SINGOLE SINGLE ADJUSTMENTS

LUNGHEZZA LENGTH	
PROFONDITÀ DEPTH	+ 30%
ALTEZZA HEIGHT	

##### RIDUZIONI COMBinate TRA LORO COMBINED ADJUSTMENTS

LUNGHEZZA + PROFONDITÀ LENGTH + DEPTH	+ 40%
--	-------

PER ULTERIORI MODIFICHE  
RICHIEDERE PREVENTIVO  
FOR MODIFICATIONS  
ASK FOR AN ESTIMATE.

**CREDENZE  
SIDEBOARDS**

**CREDENZA BOOK FLUTTUANTE H. 83  
BOOK FLOATING SIDEBOARD H. 83**

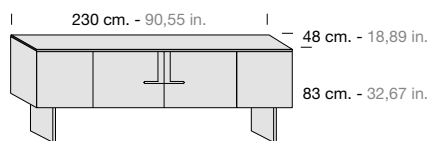

2 ANTE CON MANIGLIA, 2 ANTE LISCE  
2 RIPIANI VETRO, GAMBE VETRO  
2 DOORS WITH HANDLES, 2 SMOOTH DOORS,  
2 GLASS SHELVES, GLASS LEGS

RIPIANI LEGNO AL POSTO DI VETRO  
WOODEN SHELVES INSTEAD OF GLASS SHELVES + 320

CANALETTO	CUG2151K	OPTIONAL		
		ACS7322C		
		GAMBE VETRO FUMÉ SMOKED GLASS LEGS	TOP CERAMICA CERAMIC TOP	
	<b>4.700</b>	<b>+ 300</b>	<b>+ 1.050</b>	
	mc 1,10 – Kg 107			

**CREDENZA SHANGHAI  
SHANGHAI SIDEBOARD**

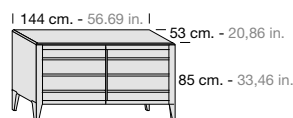

2 ANTE LEGNO, 2 RIPIANI VETRO  
2 WOODEN DOORS, 2 GLASS SHELVES

MANIGLIA INTEGRATA IN LEGNO  
INTEGRATED WOODEN HANDLE

RIPIANI LEGNO AL POSTO DI VETRO  
WOODEN SHELVES INSTEAD OF GLASS SHELVES + 99

CANALETTO	SHG2001K	OPTIONAL		
		ACS7320C	FRONTALE - FRONT	ACS2301C
		TOP CERAMICA CERAMIC TOP	SPECCHIO FUMÉ O BRONZO SMOKED OR BRONZE MIRROR	2 CASSETTI INTERNI 2 INTERNAL DRAWERS
	<b>2.600</b>	<b>+ 450</b>	<b>+ 500</b>	<b>+ 600</b>
	mc 0,81 – Kg 65			

**CREDENZA SHANGHAI  
SHANGHAI SIDEBOARD**

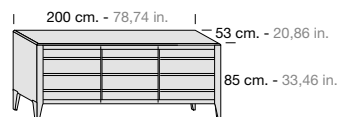

3 ANTE LEGNO, 3 RIPIANI VETRO  
3 WOODEN DOORS, 3 GLASS SHELVES

MANIGLIA INTEGRATA IN LEGNO  
INTEGRATED WOODEN HANDLE

RIPIANI LEGNO AL POSTO DI VETRO  
WOODEN SHELVES INSTEAD OF GLASS SHELVES + 136

CANALETTO	SHG2031K	OPTIONAL		
		ACS7220C	FRONTALE - FRONT	ACS2311C
		TOP CERAMICA CERAMIC TOP	SPECCHIO FUMÉ O BRONZO SMOKED OR BRONZE MIRROR	3 CASSETTI INTERNI 3 INTERNAL DRAWERS
	<b>2.950</b>	<b>+ 800</b>	<b>+ 750</b>	<b>+ 900</b>
	mc 1,01 – Kg 95			

**CREDENZA SINGAPORE  
SINGAPORE SIDEBOARD**

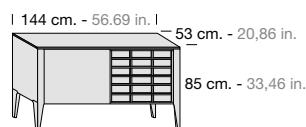

2 ANTE LEGNO, 2 RIPIANI VETRO  
2 WOODEN DOORS, 2 GLASS SHELVES

MANIGLIA INTEGRATA IN LEGNO / PUSH PULL  
INTEGRATED WOODEN HANDLE / PUSH PULL

RIPIANI LEGNO AL POSTO DI VETRO  
WOODEN SHELVES INSTEAD OF GLASS SHELVES + 99

CANALETTO	SIG2001K	OPTIONAL	
		ACS7320C	ACS2301C
		TOP CERAMICA CERAMIC TOP	2 CASSETTI INTERNI 2 INTERNAL DRAWERS
	<b>2.600</b>	<b>+ 450</b>	<b>+ 600</b>
	mc 0,81 – Kg 65		

**CREDENZA SINGAPORE  
SINGAPORE SIDEBOARD**

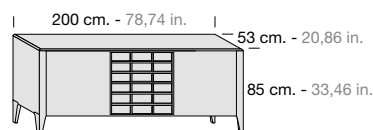

3 ANTE LEGNO, 3 RIPIANI VETRO  
3 WOODEN DOORS, 3 GLASS SHELVES

MANIGLIA INTEGRATA IN LEGNO / PUSH PULL  
INTEGRATED WOODEN HANDLE / PUSH PULL

RIPIANI LEGNO AL POSTO DI VETRO  
WOODEN SHELVES INSTEAD OF GLASS SHELVES + 136

CANALETTO	SIG2031K	OPTIONAL	
		ACS7220C	ACS2311C
		TOP CERAMICA CERAMIC TOP	3 CASSETTI INTERNI 3 INTERNAL DRAWERS
	<b>2.950</b>	<b>+ 800</b>	<b>+ 900</b>
	mc 1,01 – Kg 95		

**MAGGIORAZIONI E RIDUZIONI  
SURCHARGES AND REDUCTIONS**

**RIDUZIONI SINGOLE  
SINGLE ADJUSTMENTS**

LUNGHEZZA LENGTH	
PROFONDITÀ DEPTH	<b>+ 30%</b>
ALTEZZA HEIGHT	

**RIDUZIONI COMBinate TRA LORO  
COMBINED ADJUSTMENTS**

LUNGHEZZA + PROFONDITÀ LENGTH + DEPTH	<b>+ 40%</b>
--	--------------

PER ULTERIORI MODIFICHE  
RICHIEDERE PREVENTIVO  
FOR MODIFICATIONS  
ASK FOR AN ESTIMATE.

# GIORNO - DAY

## CREDENZE - PORTA TV SIDEBOARDS - TV UNITS

### CREDENZA DOMINO DOMINO SIDEBOARD

2 ANTE LEGNO, 2 RIPIANI VETRO  
2 WOODEN DOORS, 2 GLASS SHELVES

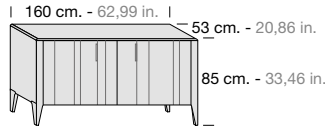

DOGA LEGNO LISCIA - MANIGLIA DOMINO  
PLAIN WOODEN SLAT - DOMINO HANDLE

RIPIANI LEGNO AL POSTO DI VETRO  
WOODEN SHELVES INSTEAD OF GLASS SHELVES + 99

DOG2026K	OPTIONAL			
	DOGA SLAT		ACS7323C	ACS2301C
	N. 1 DOGA RIGHE N. 1 RIBBED SLAT	DOGA QUADRO LEGNO WOOD SQUARE SLAT	TOP MARMO MARBLE TOP	2 CASSETTI INTERNI 2 INTERNAL DRAWERS
<b>2.900</b>				
<b>+ 5 %</b>	<b>+ 75</b>	<b>+ 110</b>	<b>+ 1.650</b>	<b>+ 600</b>
mc 0,81 - Kg 65				

CANALETTO

Doghe Multicolor - Multicolor slats

### CREDENZA DOMINO DOMINO SIDEBOARD

3 ANTE LEGNO, 3 RIPIANI VETRO  
3 WOODEN DOORS, 3 GLASS SHELVES

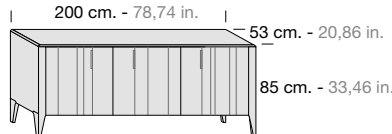

DOGA LEGNO LISCIA - MANIGLIA DOMINO  
PLAIN WOODEN SLAT - DOMINO HANDLE

RIPIANI LEGNO AL POSTO DI VETRO  
WOODEN SHELVES INSTEAD OF GLASS SHELVES + 136

DOG2036K	OPTIONAL			
	DOGA SLAT		ACS7324C	ACS2311C
	N. 2 DOGHE RIGHE N. 2 RIBBED SLATS	DOGA QUADRO LEGNO WOOD SQUARE SLAT	TOP MARMO MARBLE TOP	3 CASSETTI INTERNI 3 INTERNAL DRAWERS
<b>3.250</b>				
<b>+ 10 %</b>	<b>+ 150</b>	<b>+ 300</b>	<b>+ 2.000</b>	<b>+ 900</b>
mc 1,01 - Kg 95				

CANALETTO

Doghe Multicolor - Multicolor slats

### CREDENZA CANNAREGIO CANNAREGIO SIDEBOARD

**NEW**

2 ANTE LEGNO, 2 RIPIANI VETRO  
2 WOODEN DOORS, 2 GLASS SHELVES  
GLASS LEGS

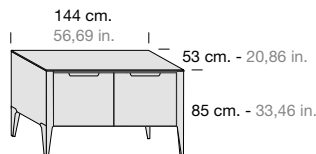

RIPIANI LEGNO AL POSTO DI VETRO  
WOODEN SHELVES INSTEAD OF GLASS SHELVES + 99

DEG2071K	OPTIONAL	
	ACS7320C	
	TOP CERAMICA CERAMIC TOP	
<b>2.500</b>		
	<b>+ 430</b>	
mc 0,81 - Kg 65		

CANALETTO

### CREDENZA CANNAREGIO CANNAREGIO SIDEBOARD

**NEW**

3 ANTE LEGNO, 3 RIPIANI VETRO  
3 WOODEN DOORS, 4 GLASS SHELVES  
GLASS LEGS

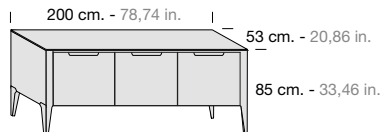

RIPIANI LEGNO AL POSTO DI VETRO  
WOODEN SHELVES INSTEAD OF GLASS SHELVES + 99

DOG2061K	OPTIONAL	
	ACS7220C	
	TOP CERAMICA CERAMIC TOP	
<b>2.900</b>		
	<b>+ 800</b>	
mc 1,01 - Kg 95		

CANALETTO

### PORTA TV SHANGHAI SHANGHAI TV UNIT

2 ANTE LEGNO E VANO A GIORNO  
2 WOODEN DOORS AND OPEN COMPARTMENT

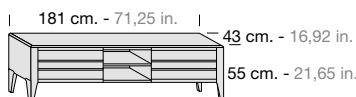

MANIGLIA INTEGRATA IN LEGNO  
INTEGRATED WOODEN HANDLE

SHG5001K	OPTIONAL	
	FRONTALE - FRONT	ACS7420C
	SPECCHIO FUMÉ O BRONZO SMOKED OR BRONZE MIRROR	TOP CERAMICA CERAMIC TOP
<b>2.700</b>		
	<b>+ 415</b>	<b>+ 700</b>
mc 0,49 - Kg 75		

CANALETTO

#### MAGGIORAZIONI E RIDUZIONI SURCHARGES AND REDUCTIONS

RIDUZIONI SINGOLE  
SINGLE ADJUSTMENTS

LUNGHEZZA LENGTH	
PROFONDITÀ DEPTH	<b>+ 30%</b>
ALTEZZA HEIGHT	

RIDUZIONI COMBinate TRA LORO  
COMBINED ADJUSTMENTS

LUNGHEZZA + PROFONDITÀ LENGTH + DEPTH	<b>+ 40%</b>
--	--------------

PER ULTERIORI MODIFICHE  
RICHIEDERE PREVENTIVO  
FOR MODIFICATIONS  
ASK FOR AN ESTIMATE.

**PORTA TV - VETRINE**  
**TV UNITS - DISPLAY UNITS**

**PORTA TV DOMINO**  
**DOMINO TV UNIT**

2 ANTE LEGNO E VANO A GIORNO  
2 WOODEN DOORS AND OPEN COMPARTMENT

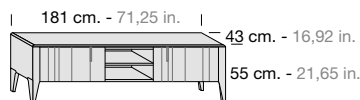

DOGA LEGNO LISCIA - MANIGLIA DOMINO  
PLAIN WOODEN SLAT - DOMINO HANDLE

	DOG5006K	OPTIONAL		
		DOGA SLAT		
		DOGA RIGHE RIBBED SLAT	DOGA QUADRO LEGNO WOOD SQUARE SLAT	TOP MARMO MARBLE TOP
<b>CANALETTO</b>	<b>3.100</b>			
Doghe Multicolor - Multicolor slats	<b>+ 10 %</b>	<b>+ 68</b>	<b>+ 105</b>	<b>+ 1.800</b>
	mc 0,49 - Kg 75			

**VETRINA YORK**  
**YORK DISPLAY UNIT**

**NEW**

2 ANTE VETRO, 2 RIPIANI VETRO  
2 GLASS DOORS, 2 GLASS SHELVES

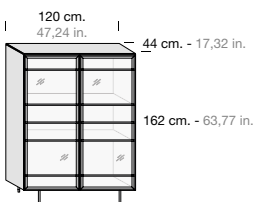

RIPIANI LEGNO AL POSTO DI VETRO  
WOODEN SHELVES INSTEAD OF GLASS SHELVES + 186

	DEG3011K	OPTIONAL		
		VETRO FUMÉ SMOKED GLASS	ACS7002C KIT 2 LUCI LED VERTICALI SUI FIANCHI KIT 2 VERTICAL LED LIGHTS ON SIDES	ACS7421C TOP CERAMICA CERAMIC TOP
<b>CANALETTO</b>	<b>3.450</b>			
		<b>+ 300</b>	<b>+ 370</b>	<b>+ 450</b>
	mc 0,90 - Kg 70			

**VETRINA YORK**  
**YORK DISPLAY UNIT**

**NEW**

3 ANTE VETRO, 2 RIPIANI VETRO  
3 GLASS DOORS, 2 GLASS SHELVES

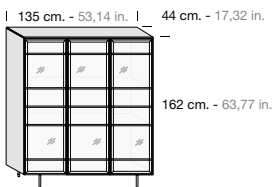

RIPIANI LEGNO AL POSTO DI VETRO  
WOODEN SHELVES INSTEAD OF GLASS SHELVES + 186

	DEG3001K	OPTIONAL		
		VETRO FUMÉ SMOKED GLASS	ACS7002C KIT 2 LUCI LED VERTICALI SUI FIANCHI KIT 2 VERTICAL LED LIGHTS ON SIDES	ACS7422C TOP CERAMICA CERAMIC TOP
<b>CANALETTO</b>	<b>4.450</b>			
		<b>+ 300</b>	<b>+ 370</b>	<b>+ 500</b>
	mc 1,35 - Kg 80			

**VETRINA SHANGHAI**  
**SHANGHAI DISPLAY UNIT**

2 ANTE VETRO CANNETÉ, 3 RIPIANI VETRO  
2 CANNETÉ GLASS DOORS, 3 GLASS SHELVES

VETRO TRASPARENTE, MANIGLIA LEGNO  
TRANSPARENT GLASS, WOODEN HANDLE

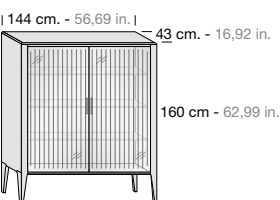

RIPIANI LEGNO AL POSTO DI VETRO  
WOODEN SHELVES INSTEAD OF GLASS SHELVES + 186

	SHG3001K	OPTIONAL	
		BARRA LED SU TOP LED LIGHT ON TOP	ACS7423C TOP CERAMICA CERAMIC TOP
<b>CANALETTO</b>	<b>3.400</b>		
		<b>+ 433</b>	<b>+ 500</b>
	mc 1,13 - Kg 60		

**VETRINA DOMINO**  
**DOMINO DISPLAY UNIT**

2 ANTE VETRO, 3 RIPIANI VETRO  
2 GLASS DOORS, 3 GLASS SHELVES

VETRO TRASPARENTE, MANIGLIA DOMINO  
TRANSPARENT GLASS, DOMINO HANDLE

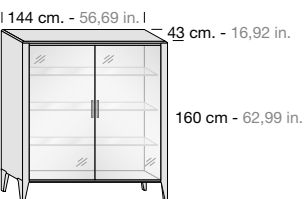

RIPIANI LEGNO AL POSTO DI VETRO  
WOODEN SHELVES INSTEAD OF GLASS SHELVES + 186

	DOG3501K	OPTIONAL	
		BARRA LED LED LIGHT	FRONTALE - FRONT FUMÉ SMOKED
<b>CANALETTO</b>	<b>2.900</b>		
		<b>+ 433</b>	<b>+ 123</b>
	mc 1,13 - Kg 60		

**MAGGIORAZIONI E RIDUZIONI**  
**SURCHARGES AND REDUCTIONS**

RIDUZIONI SINGOLE  
SINGLE ADJUSTMENTS

LUNGHEZZA LENGTH	
PROFONDITÀ DEPTH	<b>+ 30%</b>
ALTEZZA HEIGHT	

RIDUZIONI COMBinate TRA LORO  
COMBINED ADJUSTMENTS

LUNGHEZZA + PROFONDITÀ LENGTH + DEPTH	<b>+ 40%</b>
--	--------------

PER ULTERIORI MODIFICHE  
RICHIEDERE PREVENTIVO  
FOR MODIFICATIONS  
ASK FOR AN ESTIMATE.

# GIORNO - DAY

## VETRINE - MADIA - TAVOLI

### DISPLAY UNITS - TABLES

#### VETRINA DOMINO

##### DOMINO DISPLAY UNIT

2 ANTE VETRO, 2 ANTE LEGNO,  
2 RIPIANI VETRO

2 GLASS DOORS, 2 WOODEN DOORS,  
2 GLASS SHELVES

VETRO TRASPARENTE O FUMÉ,  
DOGA LEGNO LISCIA - MANIGLIA DOMINO  
TRANSPARENT OR SMOKED GLASS,  
PLAIN WOODEN SLAT - DOMINO HANDLE

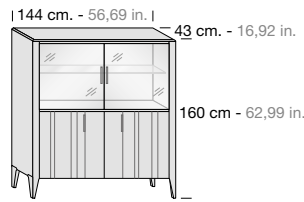

1 RIPIANO LEGNO INFERIORE AL  
POSTO DI VETRO + 74  
1 LOW WOODEN SHELF INSTEAD OF  
GLASS SHELVES

DOG3526K	OPTIONAL				
	BARRA LED LED LIGHT	ACS7423C TOP CERAMICA CERAMIC TOP	ACS7424C TOP MARMO MARBLE TOP	DOGA RIGHE RIBBED SLAT	DOGA QUADRO LEGNO WOODEN SQUARE SLAT
<b>3.700</b>					
<b>+ 5 %</b>	<b>+ 371</b>	<b>+ 500</b>	<b>+ 1.200</b>	<b>+ 63</b>	<b>+ 99</b>
mc 1,13 - Kg 60					

#### MADIA SHANGHAI

##### SHANGHAI CUPBOARD

2 ANTE LEGNO, 3 RIPIANI VETRO  
2 WOODEN DOORS, 3 GLASS SHELVES

MANIGLIA INTEGRATA IN LEGNO  
INTEGRATED WOODEN HANDLE

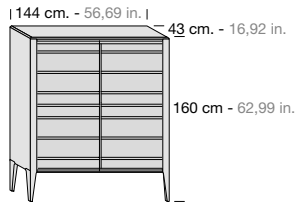

RIPIANI LEGNO AL POSTO DI VETRO  
WOODEN SHELVES INSTEAD OF GLASS SHELVES + 186

SHG2051K	OPTIONAL		
	FRONTALE - FRONT SPECCHIO FUMÉ O BRONZO SMOKED OR BRONZE MIRROR	ACS7420C 2 CASSETTI INTERNI 2 INTERNAL DRAWERS	ACS7423C TOP CERAMICA CERAMIC TOP
<b>3.350</b>			
	<b>+ 1.000</b>	<b>+ 606</b>	<b>+ 500</b>
mc 1,13 - Kg 60			

#### MAGGIORAZIONI E RIDUZIONI SURCHARGES AND REDUCTIONS

##### RIDUZIONI SINGOLE SINGLE ADJUSTMENTS

LUNGHEZZA LENGTH	
PROFONDITÀ DEPTH	<b>+ 30%</b>
ALTEZZA HEIGHT	

##### RIDUZIONI COMBinate TRA LORO COMBINED ADJUSTMENTS

LUNGHEZZA + PROFONDITÀ LENGTH + DEPTH	<b>+ 40%</b>
--	--------------

PER ULTERIORI MODIFICHE  
RICHIEDERE PREVENTIVO  
FOR MODIFICATIONS  
ASK FOR AN ESTIMATE.

#### TAVOLO HOLE OVALE HOLE OVAL TABLE

##### piano in legno wooden top

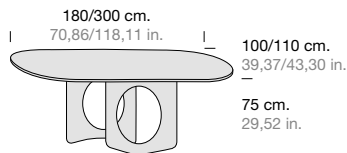

##### piano in legno spinato herringbone wooden top

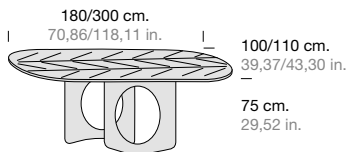

##### piano in ceramica ceramic top

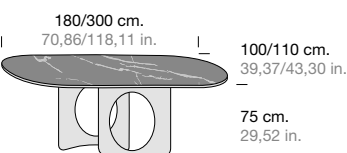

								OPTIONAL
				PIANO IN LEGNO WOODEN TOP	PIANO IN LEGNO SPINATO HERRINGBONE WOODEN TOP	PIANO IN CERAMICA CERAMIC TOP		GAMBE BRONZO O GRAFITE INCROCIATO BRONZO OR GRAPHITE INCROCIATO LEGS
cm. 180 x 100 in. 70,86 x 39,37	DEG4202K	piano in legno - wooden top	Kg. 130 M <sup>3</sup> 0,66	<b>3.300</b>				<b>+ 1.000</b>
	DEG4201K	piano in legno spinato herringbone wooden top	Kg. 130 M <sup>3</sup> 0,66		<b>4.450</b>			<b>+ 1.000</b>
	DEG4203K	piano in ceramica - ceramic top	Kg. 130 M <sup>3</sup> 0,66			<b>4.400</b>		<b>+ 1.000</b>
cm. 200 x 100 in. 78,74 x 39,37	DEG4212K	piano in legno - wooden top	Kg. 140 M <sup>3</sup> 0,69	<b>3.350</b>				<b>+ 1.000</b>
	DEG4211K	piano in legno spinato herringbone wooden top	Kg. 140 M <sup>3</sup> 0,69		<b>4.650</b>			<b>+ 1.000</b>
	DEG4213K	piano in ceramica - ceramic top	Kg. 140 M <sup>3</sup> 0,69			<b>4.500</b>		<b>+ 1.000</b>
cm. 220 x 100 in. 86,61 x 39,37	DEG4222K	piano in legno - wooden top	Kg. 150 M <sup>3</sup> 0,73	<b>3.450</b>				<b>+ 1.000</b>
	DEG4221K	piano in legno spinato herringbone wooden top	Kg. 150 M <sup>3</sup> 0,73		<b>4.700</b>			<b>+ 1.000</b>
	DEG4223K	piano in ceramica - ceramic top	Kg. 150 M <sup>3</sup> 0,73			<b>4.600</b>		<b>+ 1.000</b>
cm. 250 x 110 in. 98,42 x 43,30	DEG4232K	piano in legno - wooden top	Kg. 160 M <sup>3</sup> 0,82	<b>3.550</b>				<b>+ 1.000</b>
	DEG4231K	piano in legno spinato herringbone wooden top	Kg. 160 M <sup>3</sup> 0,82		<b>4.900</b>			<b>+ 1.000</b>
	DEG4233K	piano in ceramica - ceramic top	Kg. 160 M <sup>3</sup> 0,82			<b>4.800</b>		<b>+ 1.000</b>
cm. 300 x 110 in. 118,11 x 43,30	DEG4242K	piano in legno - wooden top	Kg. 170 M <sup>3</sup> 0,91	<b>3.900</b>				<b>+ 1.000</b>
	DEG4241K	piano in legno spinato herringbone wooden top	Kg. 170 M <sup>3</sup> 0,91		<b>5.400</b>			<b>+ 1.000</b>
	DEG4243K	piano in ceramica - ceramic top	Kg. 170 M <sup>3</sup> 0,91			<b>6.200</b>		<b>+ 1.000</b>



TAVOLI  
TABLES

TAVOLO HOLE ROTONDO  
HOLE ROUND TABLE

NEW

			PIANO IN LEGNO WOODEN TOP	PIANO IN LEGNO SPINATO HERRINGBONE WOODEN TOP	PIANO IN CERAMICA CERAMIC TOP	OPTIONAL		
						LAZY SUSAN LAZY SUSAN	GAMBE BRONZO O GRAFITE INCROCIATO BRONZO OR GRAPHITE INCROCIATO LEGS	
Ø cm. 140 Ø in. 55,11	<b>DEG4312K</b>	piano in legno - wooden top	Kg. 110 M³ 0,65	<b>3.200</b>			+ 1.300	+ 1.000
	<b>DEG4311K</b>	piano in legno spinato herringbone wooden top	Kg. 110 M³ 0,65		<b>4.350</b>		+ 1.300	+ 1.000
	<b>DEG4313K</b>	piano in ceramica - ceramic top	Kg. 110 M³ 0,65			<b>3.850</b>	+ 1.300	+ 1.000
Ø cm. 160 Ø in. 62,99	<b>DEG4322K</b>	piano in legno - wooden top	Kg. 120 M³ 0,73	<b>3.350</b>			+ 1.300	+ 1.000
	<b>DEG4321K</b>	piano in legno spinato herringbone wooden top	Kg. 120 M³ 0,73		<b>4.550</b>		+ 1.300	+ 1.000
	<b>DEG4323K</b>	piano in ceramica - ceramic top	Kg. 120 M³ 0,73			<b>4.450</b>	+ 1.300	+ 1.000
Ø cm. 180 Ø in. 70,86	<b>DEG4332K</b>	piano in legno - wooden top	Kg. 165 M³ 0,90	<b>4.250</b>			+ 1.750	+ 1.400
	<b>DEG4331K</b>	piano in legno spinato herringbone wooden top	Kg. 165 M³ 0,90		<b>6.450</b>		+ 1.750	+ 1.400
Ø cm. 200 Ø in. 78,74	<b>DEG4342K</b>	piano in legno - wooden top	Kg. 175 M³ 1,00	<b>4.450</b>			+ 1.750	+ 1.400
	<b>DEG4341K</b>	piano in legno spinato herringbone wooden top	Kg. 175 M³ 1,00		<b>7.450</b>		+ 1.750	+ 1.400
Ø cm. 220 Ø in. 86,61	<b>DEG4352K</b>	piano in legno - wooden top	Kg. 185 M³ 1,13	<b>4.650</b>			+ 1.750	+ 1.400
	<b>DEG4351K</b>	piano in legno spinato herringbone wooden top	Kg. 185 M³ 1,13		<b>7.950</b>		+ 1.750	+ 1.400

piano in legno  
wooden top

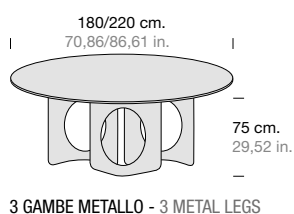
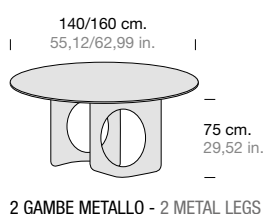

piano in legno spinato  
herringbone wooden top

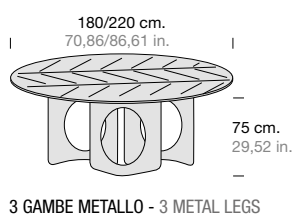
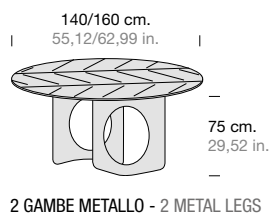

piano in ceramica  
ceramic top

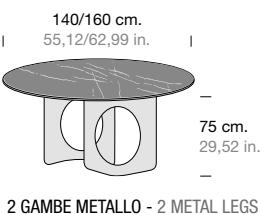

### TAVOLO TWIST OVALE OVAL TWIST TABLE

**NEW**

#### piano in legno wooden top

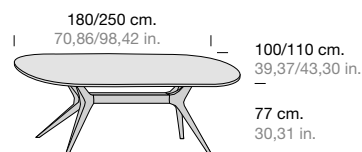

#### piano in legno spinato herringbone wooden top

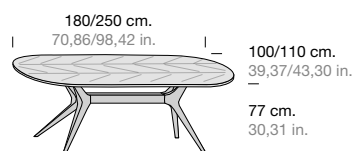

#### piano in ceramica ceramic top

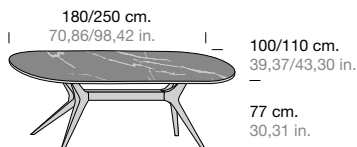

#### gambe canaletto canaletto legs

			PIANO IN LEGNO WOODEN TOP	PIANO IN LEGNO SPINATO HERRINGBONE WOODEN TOP	PIANO IN CERAMICA CERAMIC TOP	OPTIONAL 2 CASSETTI 2 DRAWERS
cm. 180 x 100 in. 70,86 x 40,94	<b>DOG4702K</b> piano in legno - wooden top	Kg. 50 M <sup>3</sup> 2,40	<b>3.000</b>			<b>ACS2331C + 600</b>
	<b>DOG4701K</b> piano in legno spinato herringbone wooden top	Kg. 50 M <sup>3</sup> 2,40		<b>4.200</b>		
	<b>DOG4703K</b> piano in ceramica - ceramic top	Kg. 70 M <sup>3</sup> 2,40			<b>3.650</b>	
cm. 200 x 100 in. 78,74 x 40,94	<b>DOG4712K</b> piano in legno - wooden top	Kg. 55 M <sup>3</sup> 2,50	<b>3.150</b>			<b>ACS2331C + 600</b>
	<b>DOG4711K</b> piano in legno spinato herringbone wooden top	Kg. 55 M <sup>3</sup> 2,50		<b>4.450</b>		
	<b>DOG4713K</b> piano in ceramica - ceramic top	Kg. 75 M <sup>3</sup> 2,50			<b>3.800</b>	
cm. 220 x 100 in. 86,61 x 40,94	<b>DOG4722K</b> piano in legno - wooden top	Kg. 60 M <sup>3</sup> 2,50	<b>3.200</b>			<b>ACS2331C + 600</b>
	<b>DOG4721K</b> piano in legno spinato herringbone wooden top	Kg. 60 M <sup>3</sup> 2,50		<b>4.500</b>		
	<b>DOG4723K</b> piano in ceramica - ceramic top	Kg. 80 M <sup>3</sup> 2,50			<b>4.300</b>	
cm. 250 x 110 in. 98,42 x 43,30	<b>DOG4732K</b> piano in legno - wooden top	Kg. 70 M <sup>3</sup> 3,00	<b>3.350</b>			<b>ACS2331C + 600</b>
	<b>DOG4731K</b> piano in legno spinato herringbone wooden top	Kg. 70 M <sup>3</sup> 3,00		<b>4.700</b>		
	<b>DOG4733K</b> piano in ceramica - ceramic top	Kg. 80 M <sup>3</sup> 3,00			<b>4.400</b>	
cm. 300 x 110 in. 118,11 x 43,30	<b>DOG4742K</b> piano in legno - wooden top	Kg. 80 M <sup>3</sup> 3,50	<b>3.600</b>			<b>ACS2331C + 600</b>
	<b>DOG4741K</b> piano in legno spinato herringbone wooden top	Kg. 80 M <sup>3</sup> 3,50		<b>5.200</b>		
	<b>DOG4743K</b> piano in ceramica - ceramic top	Kg. 100 M <sup>3</sup> 3,50			<b>4.900</b>	

#### gambe faggio

N.B. con gambe in faggio non è possibile avere la finitura olio

#### beech legs

N.B. with beech legs it is not possible to have the oil finish

			PIANO IN LEGNO WOODEN TOP	PIANO IN LEGNO SPINATO HERRINGBONE WOODEN TOP	PIANO IN CERAMICA CERAMIC TOP	OPTIONAL 2 CASSETTI 2 DRAWERS
cm. 180 x 100 in. 70,86 x 40,94	<b>DOG4705K</b> piano in legno - wooden top	Kg. 50 M <sup>3</sup> 2,40	<b>2.490</b>			<b>ACS2331C + 600</b>
	<b>DOG4704K</b> piano in legno spinato herringbone wooden top	Kg. 50 M <sup>3</sup> 2,40		<b>3.650</b>		
	<b>DOG4706K</b> piano in ceramica - ceramic top	Kg. 70 M <sup>3</sup> 2,40			<b>3.000</b>	
cm. 200 x 100 in. 78,74 x 40,94	<b>DOG4715K</b> piano in legno - wooden top	Kg. 55 M <sup>3</sup> 2,50	<b>2.600</b>			<b>ACS2331C + 600</b>
	<b>DOG4714K</b> piano in legno spinato herringbone wooden top	Kg. 55 M <sup>3</sup> 2,50		<b>3.950</b>		
	<b>DOG4716K</b> piano in ceramica - ceramic top	Kg. 75 M <sup>3</sup> 2,50			<b>3.300</b>	
cm. 220 x 100 in. 86,61 x 40,94	<b>DOG4725K</b> piano in legno - wooden top	Kg. 60 M <sup>3</sup> 2,50	<b>2.650</b>			<b>ACS2331C + 600</b>
	<b>DOG4724K</b> piano in legno spinato herringbone wooden top	Kg. 60 M <sup>3</sup> 2,50		<b>4.000</b>		
	<b>DOG4726K</b> piano in ceramica - ceramic top	Kg. 80 M <sup>3</sup> 2,50			<b>3.700</b>	
cm. 250 x 110 in. 98,42 x 43,30	<b>DOG4735K</b> piano in legno - wooden top	Kg. 70 M <sup>3</sup> 3,00	<b>2.750</b>			<b>ACS2331C + 600</b>
	<b>DOG4734K</b> piano in legno spinato herringbone wooden top	Kg. 70 M <sup>3</sup> 3,00		<b>4.200</b>		
	<b>DOG4736K</b> piano in ceramica - ceramic top	Kg. 80 M <sup>3</sup> 3,00			<b>4.400</b>	
cm. 300 x 110 in. 118,11 x 43,30	<b>DOG4745K</b> piano in legno - wooden top	Kg. 80 M <sup>3</sup> 3,50	<b>2.950</b>			<b>ACS2331C + 600</b>
	<b>DOG4744K</b> piano in legno spinato herringbone wooden top	Kg. 80 M <sup>3</sup> 3,50		<b>4.700</b>		
	<b>DOG4746K</b> piano in ceramica - ceramic top	Kg. 100 M <sup>3</sup> 3,50			<b>5.000</b>	

TAVOLI  
TABLES

TAVOLO YORK RETTANGOLARE  
YORK RECTANGULAR TABLE

piano in legno  
wooden top

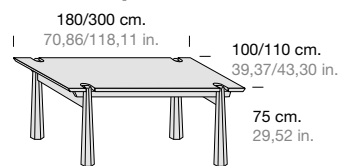

piano in vetro  
glass top

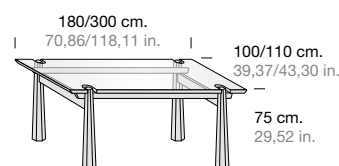

piano in ceramica  
ceramic top

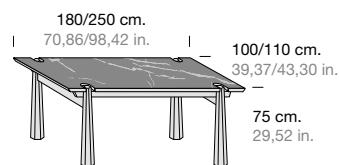

			PIANO IN LEGNO WOODEN TOP	PIANO IN VETRO GLASS TOP	PIANO IN CERAMICA CERAMIC TOP
cm. 180 x 100 in. 70,86 x 39,37	DEG4101K	piano in legno - wooden top	Kg. 50 M <sup>3</sup> 0,28	3.800	
	DEG4102K	piano in vetro - glass top	Kg. 52 M <sup>3</sup> 0,28		3.600
	DEG4103K	piano in ceramica - ceramic top	Kg. 60 M <sup>3</sup> 0,28		4.900
cm. 200 x 110 in. 78,74 x 43,30	DEG4111K	piano in legno - wooden top	Kg. 52 M <sup>3</sup> 0,30	3.900	
	DEG4112K	piano in vetro - glass top	Kg. 54 M <sup>3</sup> 0,30		3.700
	DEG4113K	piano in ceramica - ceramic top	Kg. 62 M <sup>3</sup> 0,30		5.200
cm. 220 x 120 in. 86,61 x 47,24	DEG4121K	piano in legno - wooden top	Kg. 54 M <sup>3</sup> 0,32	4.000	
	DEG4122K	piano in vetro - glass top	Kg. 56 M <sup>3</sup> 0,32		3.900
	DEG4123K	piano in ceramica - ceramic top	Kg. 64 M <sup>3</sup> 0,32		5.400
cm. 250 x 120 in. 98,42 x 47,24	DEG4131K	piano in legno - wooden top	Kg. 56 M <sup>3</sup> 0,34	4.200	
	DEG4132K	piano in vetro - glass top	Kg. 58 M <sup>3</sup> 0,34		4.000
	DEG4133K	piano in ceramica - ceramic top	Kg. 66 M <sup>3</sup> 0,34		5.800
cm. 300 x 120 in. 118,11 x 47,24	DEG4141K	piano in legno - wooden top	Kg. 58 M <sup>3</sup> 0,36	4.800	
	DEG4142K	piano in vetro - glass top	Kg. 60 M <sup>3</sup> 0,36		4.100

TAVOLO YORK PIANO A BOTTE  
YORK BARREL TOP TABLE

piano in legno  
wooden top

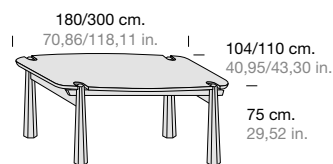

piano in vetro  
glass top

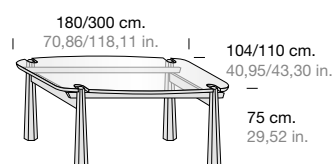

piano in ceramica  
ceramic top

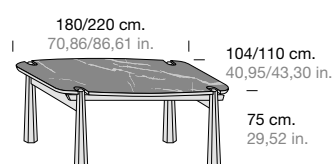

			PIANO IN LEGNO WOODEN TOP	PIANO IN VETRO GLASS TOP	PIANO IN CERAMICA CERAMIC TOP
cm. 180 x 100 in. 70,86 x 40,94	DEG4001K	piano in legno - wooden top	Kg. 50 M <sup>3</sup> 0,28	3.900	
	DEG4002K	piano in vetro - glass top	Kg. 52 M <sup>3</sup> 0,28		3.700
	DEG4003K	piano in ceramica - ceramic top	Kg. 60 M <sup>3</sup> 0,28		4.900
cm. 200 x 100 in. 78,74 x 40,94	DEG4011K	piano in legno - wooden top	Kg. 52 M <sup>3</sup> 0,30	4.000	
	DEG4012K	piano in vetro - glass top	Kg. 54 M <sup>3</sup> 0,30		3.800
	DEG4013K	piano in ceramica - ceramic top	Kg. 62 M <sup>3</sup> 0,30		5.200
cm. 220 x 110 in. 86,61 x 40,94	DEG4021K	piano in legno - wooden top	Kg. 54 M <sup>3</sup> 0,32	4.200	
	DEG4022K	piano in vetro - glass top	Kg. 56 M <sup>3</sup> 0,32		4.000
	DEG4023K	piano in ceramica - ceramic top	Kg. 64 M <sup>3</sup> 0,32		5.400
cm. 250 x 120 in. 98,42 x 43,30	DEG4031K	piano in legno - wooden top	Kg. 56 M <sup>3</sup> 0,34	4.500	
	DEG4032K	piano in vetro - glass top	Kg. 58 M <sup>3</sup> 0,34		4.300
	DEG4033K	piano in ceramica - ceramic top	Kg. 66 M <sup>3</sup> 0,34		5.800
cm. 300 x 120 in. 86,61 x 43,30	DEG4041K	piano in legno - wooden top	Kg. 58 M <sup>3</sup> 0,36	4.900	
	DEG4042K	piano in vetro - glass top	Kg. 60 M <sup>3</sup> 0,36		4.600

### TAVOLO FOSTER RETTANGOLARE FOSTER RECTANGULAR TABLE

#### piano in legno wooden top

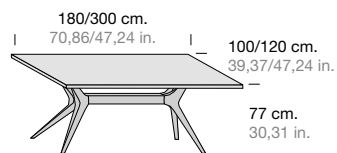

#### piano in vetro glass top

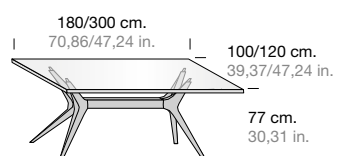

#### piano in ceramica ceramic top

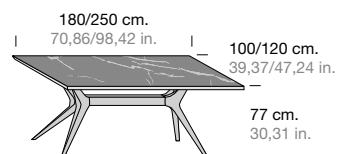

#### gambe canaletto canaletto legs

				PIANO IN LEGNO WOODEN TOP	PIANO IN VETRO GLASS TOP	PIANO IN CERAMICA CERAMIC TOP
cm. 180 x 100 in. 70,86 x 39,37	<b>DOG4082K</b> piano in legno - wooden top	Kg. 60 M <sup>3</sup> 1,80	<b>2.400</b>			
	<b>DOG4092K</b> piano in vetro - glass top	Kg. 65 M <sup>3</sup> 1,80		<b>2.700</b>		
	<b>DOG4602K</b> piano in ceramica - ceramic top	Kg. 70 M <sup>3</sup> 1,80			<b>3.600</b>	
cm. 200 x 100 in. 78,74 x 39,37	<b>DOG4042K</b> piano in legno - wooden top	Kg. 65 M <sup>3</sup> 1,85	<b>2.500</b>			
	<b>DOG4072K</b> piano in vetro - glass top	Kg. 70 M <sup>3</sup> 1,85		<b>2.780</b>		
	<b>DOG4612K</b> piano in ceramica - ceramic top	Kg. 75 M <sup>3</sup> 1,85			<b>3.850</b>	
cm. 220 x 110 in. 86,61 x 43,30	<b>DOG4402K</b> piano in legno - wooden top	Kg. 70 M <sup>3</sup> 1,95	<b>2.650</b>			
	<b>DOG4412K</b> piano in vetro - glass top	Kg. 75 M <sup>3</sup> 1,95		<b>2.850</b>		
	<b>DOG4422K</b> piano in ceramica - ceramic top	Kg. 80 M <sup>3</sup> 1,95			<b>4.300</b>	
cm. 250 x 120 in. 98,42 x 47,24	<b>DOG4442K</b> piano in legno - wooden top	Kg. 75 M <sup>3</sup> 2,00	<b>2.950</b>			
	<b>DOG4452K</b> piano in vetro - glass top	Kg. 80 M <sup>3</sup> 2,00		<b>2.890</b>		
	<b>DOG4462K</b> piano in ceramica - ceramic top	Kg. 85 M <sup>3</sup> 2,00			<b>4.900</b>	
cm. 300 x 120 in. 118,11 x 47,24	<b>DOG4472K</b> piano in legno - wooden top	Kg. 95 M <sup>3</sup> 2,20	<b>3.250</b>			
	<b>DOG4482K</b> piano in vetro - glass top	Kg. 95 M <sup>3</sup> 2,20		<b>2.950</b>		

#### gambe faggio beech legs

N.B. con gambe in faggio non è possibile avere la finitura olio

#### beech legs

N.B. with beech legs it is not possible to have the oil finish

				PIANO IN LEGNO WOODEN TOP	PIANO IN VETRO GLASS TOP	PIANO IN CERAMICA CERAMIC TOP
cm. 180 x 100 in. 70,86 x 39,37	<b>DOG4081K</b> piano in legno - wooden top	Kg. 60 M <sup>3</sup> 1,80	<b>1.800</b>			
	<b>DOG4091K</b> piano in vetro - glass top	Kg. 65 M <sup>3</sup> 1,80		<b>2.200</b>		
	<b>DOG4601K</b> piano in ceramica - ceramic top	Kg. 70 M <sup>3</sup> 1,80			<b>3.000</b>	
cm. 200 x 100 in. 78,74 x 39,37	<b>DOG4041K</b> piano in legno - wooden top	Kg. 65 M <sup>3</sup> 1,85	<b>1.950</b>			
	<b>DOG4071K</b> piano in vetro - glass top	Kg. 70 M <sup>3</sup> 1,85		<b>2.250</b>		
	<b>DOG4611K</b> piano in ceramica - ceramic top	Kg. 75 M <sup>3</sup> 1,85			<b>3.300</b>	
cm. 220 x 110 in. 86,61 x 43,30	<b>DOG4401K</b> piano in legno - wooden top	Kg. 70 M <sup>3</sup> 1,95	<b>2.100</b>			
	<b>DOG4411K</b> piano in vetro - glass top	Kg. 75 M <sup>3</sup> 1,95		<b>2.280</b>		
	<b>DOG4421K</b> piano in ceramica - ceramic top	Kg. 80 M <sup>3</sup> 1,95			<b>3.750</b>	
cm. 250 x 120 in. 98,42 x 47,24	<b>DOG4441K</b> piano in legno - wooden top	Kg. 75 M <sup>3</sup> 2,00	<b>2.400</b>			
	<b>DOG4451K</b> piano in vetro - glass top	Kg. 80 M <sup>3</sup> 2,00		<b>2.330</b>		
	<b>DOG4461K</b> piano in ceramica - ceramic top	Kg. 85 M <sup>3</sup> 2,00			<b>4.400</b>	
cm. 300 x 120 in. 118,11 x 47,24	<b>DOG4471K</b> piano in legno - wooden top	Kg. 95 M <sup>3</sup> 2,20	<b>2.750</b>			
	<b>DOG4481K</b> piano in vetro - glass top	Kg. 95 M <sup>3</sup> 2,20		<b>2.380</b>		

TAVOLI  
TABLES

TAVOLO FORSTER PIANO ROTONDO  
FOSTER ROUND TOP TABLE

NEW

piano in legno  
wooden top

120/130 cm.  
47,24/ 51,18 in.



77 cm.  
30,31 in.

3 GAMBE LEGNO - 3 WOODEN LEGS

140/180 cm.  
55,11/70,87 in.



77 cm.  
30,31 in.

4 GAMBE LEGNO - 4 WOODEN LEGS

piano in vetro  
glass top

120/130 cm.  
47,24/ 51,18 in.



77 cm.  
30,31 in.

3 GAMBE LEGNO - 3 WOODEN LEGS

140/180 cm.  
55,11/70,87 in.



77 cm.  
30,31 in.

4 GAMBE LEGNO - 4 WOODEN LEGS

piano in ceramica  
ceramic top

120/130 cm.  
47,24/ 51,18 in.



77 cm.  
30,31 in.

3 GAMBE LEGNO - 3 WOODEN LEGS

140/180 cm.  
55,11/70,87 in.



77 cm.  
30,31 in.

4 GAMBE LEGNO - 4 WOODEN LEGS

gambe canaletto  
canaletto legs

Ø cm. 120  
Ø in. 47,24

Ø cm. 130  
Ø in. 51,18

Ø cm. 140  
Ø in. 55,11

Ø cm. 150  
Ø in. 59,05

Ø cm. 160  
Ø in. 62,99

Ø cm. 180  
Ø in. 70,87

gambe faggio

N.B. con gambe in faggio non è possibile avere la finitura olio

beech legs

N.B. with beech legs it is not possible to have the oil finish

Ø cm. 120  
Ø in. 47,24

Ø cm. 130  
Ø in. 51,18

Ø cm. 140  
Ø in. 55,11

Ø cm. 150  
Ø in. 59,05

Ø cm. 160  
Ø in. 62,99

Ø cm. 180  
Ø in. 70,87

	PIANO IN LEGNO WOODEN TOP	PIANO IN VETRO GLASS TOP	PIANO IN CERAMICA CERAMIC TOP	OPTIONAL LAZY SUSAN CERAMICA CERAMIC LAZY SUSAN
--	------------------------------	-----------------------------	----------------------------------	---

DOG4052K	piano in legno - wooden top	Kg. 45 M³ 1,25	2.350		
DOG4252K	piano in vetro - glass top	Kg. 50 M³ 1,25		2.100	
DOG4242K	piano in ceramica - ceramic top	Kg. 50 M³ 1,25			2.700
DOG4332K	piano in legno - wooden top	Kg. 50 M³ 1,48	2.400		
DOG4432K	piano in vetro - glass top	Kg. 56 M³ 1,48		2.250	
DOG4622K	piano in ceramica - ceramic top	Kg. 56 M³ 1,48			2.900
DOG4032K	piano in legno - wooden top	Kg. 52 M³ 1,55	2.650		+ 1.300
DOG4232K	piano in vetro - glass top	Kg. 62 M³ 1,55		2.600	+ 1.300
DOG4632K	piano in ceramica - ceramic top	Kg. 62 M³ 1,55			3.500 + 1.300
DOG4062K	piano in legno - wooden top	Kg. 60 M³ 1,60	2.700		+ 1.750
DOG4262K	piano in vetro - glass top	Kg. 70 M³ 1,60		2.800	+ 1.750
DOG4642K	piano in ceramica - ceramic top	Kg. 70 M³ 1,60			3.800 + 1.750
DOG4112K	piano in legno - wooden top	Kg. 65 M³ 1,70	2.850		+ 1.750
DOG4212K	piano in vetro - glass top	Kg. 78 M³ 1,70		3.000	+ 1.750
DOG4652K	piano in ceramica - ceramic top	Kg. 78 M³ 1,70			4.200 + 1.750
DOG4442K	piano in legno - wooden top	Kg. 70 M³ 1,80	2.980		+ 1.750
DOG4452K	piano in vetro - glass top	Kg. 70 M³ 1,80		3.300	+ 1.750

	PIANO IN LEGNO WOODEN TOP	PIANO IN VETRO GLASS TOP	PIANO IN CERAMICA CERAMIC TOP	OPTIONAL LAZY SUSAN CERAMICA CERAMIC LAZY SUSAN
--	------------------------------	-----------------------------	----------------------------------	---

DOG4051K	piano in legno - wooden top	Kg. 45 M³ 1,25	1.900		
DOG4251K	piano in vetro - glass top	Kg. 50 M³ 1,25		1.700	
DOG4241K	piano in ceramica - ceramic top	Kg. 50 M³ 1,25			2.300
DOG4331K	piano in legno - wooden top	Kg. 50 M³ 1,48	2.000		
DOG4431K	piano in vetro - glass top	Kg. 56 M³ 1,48		1.800	
DOG4621K	piano in ceramica - ceramic top	Kg. 56 M³ 1,48			2.600
DOG4031K	piano in legno - wooden top	Kg. 52 M³ 1,55	2.200		+ 1.300
DOG4231K	piano in vetro - glass top	Kg. 62 M³ 1,55		2.000	+ 1.300
DOG4632K	piano in ceramica - ceramic top	Kg. 62 M³ 1,55			2.900 + 1.300
DOG4061K	piano in legno - wooden top	Kg. 60 M³ 1,60	2.250		+ 1.750
DOG4261K	piano in vetro - glass top	Kg. 70 M³ 1,60		2.350	+ 1.750
DOG4641K	piano in ceramica - ceramic top	Kg. 70 M³ 1,60			3.300 + 1.750
DOG4111K	piano in legno - wooden top	Kg. 65 M³ 1,70	2.350		+ 1.750
DOG4211K	piano in vetro - glass top	Kg. 78 M³ 1,70		2.500	+ 1.750
DOG4651K	piano in ceramica - ceramic top	Kg. 78 M³ 1,70			3.600 + 1.750
DOG4441K	piano in legno - wooden top	Kg. 70 M³ 1,80	2.500		+ 1.750
DOG4451K	piano in vetro - glass top	Kg. 70 M³ 1,80		2.850	+ 1.750

## TAVOLI TABLES

### TAVOLO FOSTER ELLITTICO ELLIPTICAL FOSTER TABLE

**NEW**

#### piano in legno wooden top

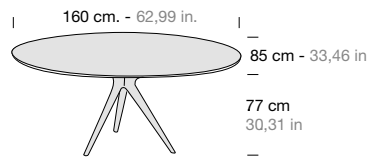

#### piano in vetro glass top



#### piano in ceramica ceramic top

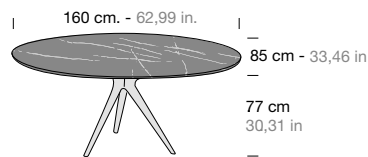

#### gambe canaletto canaletto legs

			PIANO IN LEGNO WOODEN TOP	PIANO IN VETRO GLASS TOP	PIANO IN CERAMICA CERAMIC TOP
cm. 160 x 85 in. 62,99 x 33,46	<b>DOG4951K</b> piano in legno - wooden top	Kg. 60 M <sup>3</sup> 1,10	<b>2.350</b>		
	<b>DOG4952K</b> piano in vetro - glass top	Kg. 60 M <sup>3</sup> 1,10		<b>2.150</b>	
	<b>DOG4953K</b> piano in ceramica - ceramic top	Kg. 60 M <sup>3</sup> 1,10			<b>2.700</b>

#### gambe faggio beech legs

N.B. con gambe in faggio non è possibile avere la finitura olio

#### beech legs

N.B. with beech legs it is not possible to have the oil finish

			PIANO IN LEGNO WOODEN TOP	PIANO IN VETRO GLASS TOP	PIANO IN CERAMICA CERAMIC TOP
cm. 160 x 85 in. 62,99 x 33,46	<b>DOG4954K</b> piano in legno - wooden top	Kg. 60 M <sup>3</sup> 1,10	<b>1.900</b>		
	<b>DOG4955K</b> piano in vetro - glass top	Kg. 60 M <sup>3</sup> 1,10		<b>1.700</b>	
	<b>DOG4956K</b> piano in ceramica - ceramic top	Kg. 60 M <sup>3</sup> 1,10			<b>2.300</b>

### TAVOLO NORMAN PIANO RETTANGOLARE NORMAN RECTANGULAR TOP TABLE

#### piano in ceramica o vetro effetto marmo ceramic or glass marble effect top

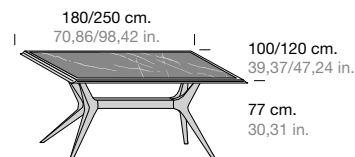

#### gambe canaletto canaletto legs

			PIANO IN CERAMICA CERAMIC TOP		
cm. 180 x 100 - in. 70,86 x 39,37	<b>DOG4301K</b> piano in ceramica - ceramic top	Kg. 60 M <sup>3</sup> 1,30			<b>6.450</b>
cm. 200 x 100 - in. 78,74 x 39,37	<b>DOG4311K</b> piano in ceramica - ceramic top	Kg. 63 M <sup>3</sup> 1,32			<b>6.550</b>
cm. 220 x 110 - in. 86,61 x 43,30	<b>DOG4341K</b> piano in ceramica - ceramic top	Kg. 65 M <sup>3</sup> 1,34			<b>6.750</b>
cm. 250 x 120 - in. 98,42 x 47,24	<b>DOG4351K</b> piano in ceramica - ceramic top	Kg. 70 M <sup>3</sup> 1,37			<b>6.950</b>

#### gambe faggio N.B. con gambe in faggio non è possibile avere la finitura olio

beech legs N.B. with beech legs it is not possible to have the oil finish

			PIANO IN CERAMICA CERAMIC TOP		
cm. 180 x 100 - in. 70,86 x 39,37	<b>DOG4302K</b> piano in ceramica - ceramic top	Kg. 60 M <sup>3</sup> 1,30			<b>5.850</b>
cm. 200 x 100 - in. 78,74 x 39,37	<b>DOG4312K</b> piano in ceramica - ceramic top	Kg. 63 M <sup>3</sup> 1,32			<b>5.950</b>
cm. 220 x 110 - in. 86,61 x 43,30	<b>DOG4342K</b> piano in ceramica - ceramic top	Kg. 65 M <sup>3</sup> 1,34			<b>6.250</b>
cm. 250 x 120 - in. 98,42 x 47,24	<b>DOG4352K</b> piano in ceramica - ceramic top	Kg. 70 M <sup>3</sup> 1,37			<b>6.450</b>

**SEDIE  
CHAIRS**

**SEDIA BARCELONA**  
SEDILE E SCHIENALE IMBOTTITO  
TESSUTO CLIENTE  
MT. LINEARI NECESSARI: 1,70

**BARCELONA CHAIR**  
UPHOLSTERED BACK PANEL AND SEAT  
CUSTOMER'S FABRIC  
METERS LINEAR NEEDED: 1,70

ESSENZA FUSTO FAGGIO  
CARCASE IN BEECH  
WOOD RANGE

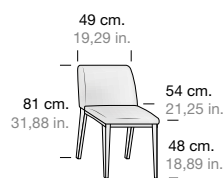

PER ESSENZA FAGGIO NON POSSIBILE LA  
FINITURA OLIO  
OIL FINISH IS NOT POSSIBLE FOR BEECH  
ESSENCE

DOG1021K			
CAT. A	CAT. B	CAT. C	CAT. COM
ECOPELLE/ECONABUK FAUX LEATHER/ECONABUK	LINO/VELLUTO/BOUCLÉ LINEN/VELVET/BOUCLÉ	PELLE LEATHER	TESSUTO CLIENTE C.O.M. CUSTOMER FABRIC
<b>450</b>	<b>500</b>	<b>610</b>	<b>430</b>

mc 0,24 – Kg 15

FAGGIO

**SEDIA SHANGHAI**  
SEDILE E SCHIENALE IMBOTTITO  
TESSUTO CLIENTE  
MT. LINEARI NECESSARI: 0,70

**SHANGHAI CHAIR**  
UPHOLSTERED BACK PANEL AND SEAT  
CUSTOMER'S FABRIC  
METERS LINEAR NEEDED: 0,70

SENZA BRACCIOLI  
WITHOUT ARMREST

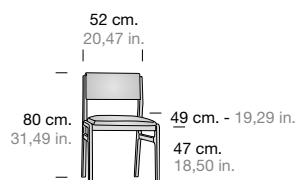

SHG1012K			
CAT. A	CAT. B	CAT. C	CAT. COM
ECOPELLE/ECONABUK FAUX LEATHER/ECONABUK	LINO/VELLUTO/BOUCLÉ LINEN/VELVET/BOUCLÉ	PELLE LEATHER	TESSUTO CLIENTE C.O.M. CUSTOMER FABRIC
<b>720</b>	<b>785</b>	<b>950</b>	<b>670</b>

mc 0,25 – Kg 13

CON BRACCIOLI  
WITH ARMREST

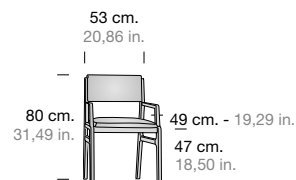

SHG1022K			
CAT. A	CAT. B	CAT. C	CAT. COM
ECOPELLE/ECONABUK FAUX LEATHER/ECONABUK	LINO/VELLUTO/BOUCLÉ LINEN/VELVET/BOUCLÉ	PELLE LEATHER	TESSUTO CLIENTE C.O.M. CUSTOMER FABRIC
<b>770</b>	<b>850</b>	<b>990</b>	<b>720</b>

mc 0,26 – Kg 14

**SEDIA DOMINO**  
SEDILE E SCHIENALE IMBOTTITO  
TESSUTO CLIENTE  
MT. LINEARI NECESSARI: 1,20

**DOMINO CHAIR**  
UPHOLSTERED BACK PANEL AND SEAT  
CUSTOMER'S FABRIC  
METERS LINEAR NEEDED: 1,20

ESSENZA FUSTO FAGGIO  
CARCASE IN BEECH  
WOOD RANGE

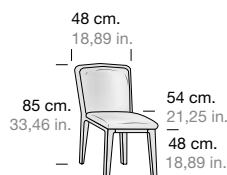

DOG1011K			
CAT. A	CAT. B	CAT. C	CAT. COM
ECOPELLE/ECONABUK FAUX LEATHER/ECONABUK	LINO/VELLUTO/BOUCLÉ LINEN/VELVET/BOUCLÉ	PELLE LEATHER	TESSUTO CLIENTE C.O.M. CUSTOMER FABRIC
<b>590</b>	<b>640</b>	<b>795</b>	<b>560</b>

mc 0,25 – Kg 15

ESSENZA FUSTO  
CANALETTO  
CARCASE IN CANALETTO  
WOOD RANGE

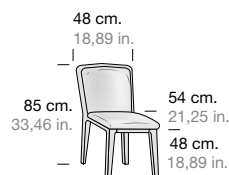

DOG1012K			
CAT. A	CAT. B	CAT. C	CAT. COM
ECOPELLE/ECONABUK FAUX LEATHER/ECONABUK	LINO/VELLUTO/BOUCLÉ LINEN/VELVET/BOUCLÉ	PELLE LEATHER	TESSUTO CLIENTE C.O.M. CUSTOMER FABRIC
<b>745</b>	<b>795</b>	<b>955</b>	<b>700</b>

mc 0,25 – Kg 15

PER ESSENZA FAGGIO NON POSSIBILE LA  
FINITURA OLIO  
OIL FINISH IS NOT POSSIBLE FOR BEECH  
ESSENCE

FAGGIO

**SEDIA BOLOGNA**  
SEDILE IMBOTTITO  
TESSUTO CLIENTE  
MT. LINEARI NECESSARI: 0,60

**BOLOGNA CHAIR**  
UPHOLSTERED SEAT  
CUSTOMER'S FABRIC  
METERS LINEAR NEEDED: 0,60

ESSENZA FUSTO FAGGIO  
CARCASE IN BEECH  
WOOD RANGE

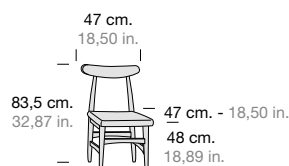

DEG1021K			
CAT. A	CAT. B	CAT. C	CAT. COM
ECOPELLE/ECONABUK FAUX LEATHER/ECONABUK	LINO/VELLUTO/BOUCLÉ LINEN/VELVET/BOUCLÉ	PELLE LEATHER	TESSUTO CLIENTE C.O.M. CUSTOMER FABRIC
<b>1.090</b>	<b>1.190</b>	<b>1.295</b>	<b>980</b>

mc 0,27 – Kg 15

ESSENZA FUSTO  
CANALETTO  
CARCASE IN CANALETTO  
WOOD RANGE

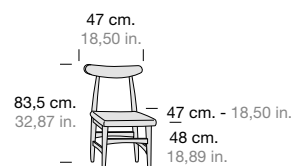

DEG1022K			
CAT. A	CAT. B	CAT. C	CAT. COM
ECOPELLE/ECONABUK FAUX LEATHER/ECONABUK	LINO/VELLUTO/BOUCLÉ LINEN/VELVET/BOUCLÉ	PELLE LEATHER	TESSUTO CLIENTE C.O.M. CUSTOMER FABRIC
<b>1.550</b>	<b>1.750</b>	<b>1.850</b>	<b>1.500</b>

mc 0,27 – Kg 15

**NEW**

PER ESSENZA FAGGIO NON POSSIBILE LA  
FINITURA OLIO  
OIL FINISH IS NOT POSSIBLE FOR BEECH  
ESSENCE

## SEDIE CHAIRS

**SEDIA CANNAREGIO**  
**SEDILE IMBOTTITO**  
**TESSUTO CLIENTE**  
**MT. LINEARI NECESSARI: 0,60**

**CANNAREGIO CHAIR**  
**UPHOLSTERED SEAT**  
**CUSTOMER'S FABRIC**  
**METERS LINEAR NEEDED: 0,60**

**NEW**

ESSENZA FUSTO FAGGIO  
 CARCASE IN BEECH  
 WOOD RANGE

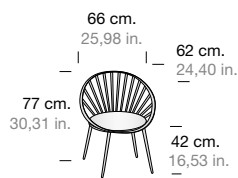

DEG1011K				
SENZA CUSCINO WITHOUT CUSHION	CAT. A ECOPELLE/ECONABUK FAUX LEATHER/ECONABUK	CAT. B LINO/VELLUTO/BOUCLÉ LINEN/VELVET/BOUCLÉ	CAT. C PELLE LEATHER	CAT. COM TESSUTO CLIENTE C.O.M. CUSTOMER FABRIC
<b>800</b>	<b>1.090</b>	<b>1.190</b>	<b>1.295</b>	<b>980</b>

mc 0,39 – Kg 17

**SEDIA CANNAREGIO**  
**SEDILE IMBOTTITO**  
**TESSUTO CLIENTE**  
**MT. LINEARI NECESSARI: 0,60**

**CANNAREGIO CHAIR**  
**UPHOLSTERED SEAT**  
**CUSTOMER'S FABRIC**  
**METERS LINEAR NEEDED: 0,60**

**NEW**

ESSENZA FUSTO  
 CANALETTO  
 CARCASE IN  
 CANALETTO  
 WOOD RANGE

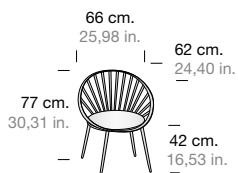

DEG1012K				
SENZA CUSCINO WITHOUT CUSHION	CAT. A ECOPELLE/ECONABUK FAUX LEATHER/ECONABUK	CAT. B LINO/VELLUTO/BOUCLÉ LINEN/VELVET/BOUCLÉ	CAT. C PELLE LEATHER	CAT. COM TESSUTO CLIENTE C.O.M. CUSTOMER FABRIC
<b>1.350</b>	<b>1.550</b>	<b>1.750</b>	<b>1.850</b>	<b>1.500</b>

mc 0,39 – Kg 17

**SEDIA CANNAREGIO**  
**SEDILE IMBOTTITO**  
**TESSUTO CLIENTE**  
**MT. LINEARI NECESSARI: 0,60**

**CANNAREGIO CHAIR**  
**UPHOLSTERED SEAT**  
**CUSTOMER'S FABRIC**  
**METERS LINEAR NEEDED: 0,60**

**NEW**

ESSENZA FUSTO FRASSINO  
 CARCASE IN ASH  
 WOOD RANGE

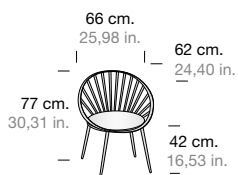

DEG1013K				
SENZA CUSCINO WITHOUT CUSHION	CAT. A ECOPELLE/ECONABUK FAUX LEATHER/ECONABUK	CAT. B LINO/VELLUTO/BOUCLÉ LINEN/VELVET/BOUCLÉ	CAT. C PELLE LEATHER	CAT. COM TESSUTO CLIENTE C.O.M. CUSTOMER FABRIC
<b>950</b>	<b>1.250</b>	<b>1.280</b>	<b>1.360</b>	<b>1.200</b>

mc 0,39 – Kg 17



**SPECCHIERE  
MIRRORS**

**SPECCHIERA YORK  
YORK MIRROR**

PICCOLA  
SMALL

MEDIA  
MEDIUM

CORNICE IN LEGNO, SPECCHIO ARGENTO  
POSIZIONABILE A 360°  
WOODEN FRAME, SILVER MIRROR  
ADJUSTABLE 360°

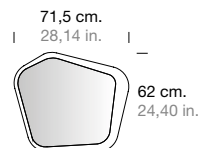
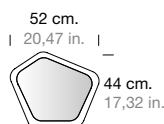

**DEN9001K**

**DEN9011K**

CANALETTO

**800**

mc 0,01 – Kg 10

**900**

mc 0,02 – Kg 20

GRANDE  
LARGE

VERTICALE  
VERTICAL

CORNICE IN LEGNO, SPECCHIO ARGENTO  
POSIZIONABILE A 360°  
WOODEN FRAME, SILVER MIRROR  
ADJUSTABLE 360°

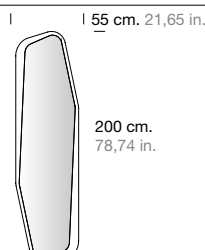
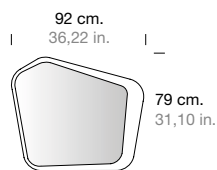

**DEN9021K**

**DEN9041K**

CANALETTO

**1.200**

mc 0,01 – Kg 10

**2.000**

mc 0,04 – Kg 30

**SPECCHIERA DORIAN GRAY  
DORIAN GRAY MIRROR**

CORNICE IN METALLO, SPECCHIO ARGENTO  
METAL FRAME, SILVER MIRROR

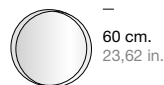

CON LED  
WITH LED LIGHTS

SENZA LED  
WITHOUT LED LIGHTS

CON LED  
WITH LED LIGHTS

SENZA LED  
WITHOUT LED LIGHTS

**DEN9201K**

**DEN9101K**

**DEN9211K**

**DEN9111K**

**OPTIONAL**

**850**

**450**

mc 0,02 – Kg 8

**950**

**500**

mc 0,03 – Kg 13

FINITURA BRONZO E GRAFITE  
BRONZO AND GRAFITE FINISH

**+ 700**

CORNICE IN METALLO, SPECCHIO ARGENTO  
METAL FRAME, SILVER MIRROR

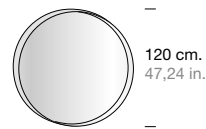
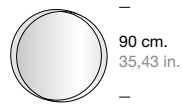

CON LED  
WITH LED LIGHTS

SENZA LED  
WITHOUT LED LIGHTS

CON LED  
WITH LED LIGHTS

SENZA LED  
WITHOUT LED LIGHTS

**DEN9221K**

**DEN9121K**

**DEN9231K**

**DEN9131K**

**OPTIONAL**

**1.100**

**630**

mc 0,07 – Kg 24

**1.250**

**780**

mc 0,13 – Kg 39

FINITURA BRONZO E GRAFITE  
BRONZO AND GRAFITE FINISH

**+ 900**

## SPECCHIERE MIRRORS

### SPECCHIERA SHANGHAI SHANGHAI MIRROR

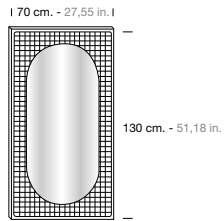

SPECCHIO ARGENTO  
SILVER MIRROR

**SHN9001K**

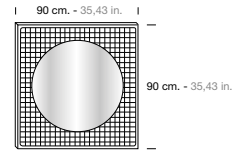

SPECCHIO ARGENTO  
SILVER MIRROR

**SHN9011K**

PAGLIA DI VIENNA  
VIENNA STRAW

CANALETTO

**980**  
mc 0,028 – Kg 38

**800**  
mc 0,02 – Kg 30

### SPECCHIERA SINGAPORE SINGAPORE MIRROR

VERSIONE LEGNO - SPECCHIO  
WOOD - MIRROR VERSION

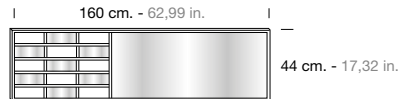

SPECCHIO ARGENTO  
SILVER MIRROR

**SHN9031K**

VERSIONE TUTTO SPECCHIO  
ALL MIRROR VERSION



SPECCHIO ARGENTO  
SILVER MIRROR

**SHN9021K**

CANALETTO

**1.400**  
mc 0,03 – Kg 35

**1.300**  
mc 0,03 – Kg 35

### SPECCHIERA THAI THAI MIRROR

ORIZZONTALE / VERTICALE  
HORIZONTAL / VERTICAL

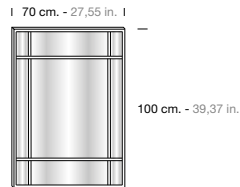

SPECCHIO ARGENTO  
SILVER MIRROR

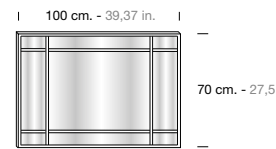

SPECCHIO ARGENTO  
SILVER MIRROR

**SHN9041K**

CANALETTO

**850**  
mc 0,025 – Kg 25

### SPECCHIERA DOMINO DOMINO MIRROR

SPECCHIERA DOMINO  
ORIZZONTALE / VERTICALE  
HORIZONTAL / VERTICAL  
DOMINO MIRROR

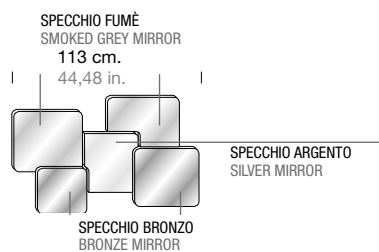

**DON9001K**

**900**  
mc 0,06 – Kg 17

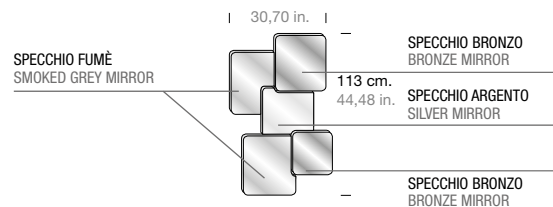

### SPECCHIERA PEDRERA PEDRERA MIRROR

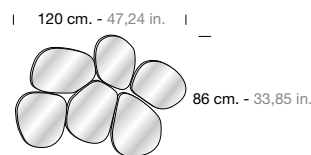

SPECCHIO ARGENTO  
SILVER MIRROR

**DON9011K**

**980**  
mc 0,03 – Kg 17

CONSOLE  
CONSOLES

CONSOLE YORK  
YORK CONSOLE

NON AUTOPORTANTE,  
NECESSARIO FISSAGGIO A MURO.  
NOT SELF SUPPORTING,  
WALL MOUNTING NECESSARY.



				PIANO IN LEGNO WOODEN TOP	PIANO IN VETRO GLASS TOP	PIANO IN CERAMICA CERAMIC TOP	OPTIONAL
cm. 130 x 40 in. 51,18 x 29,52	<b>DEG5701K</b>	piano in legno - wooden top	Kg. 55 M <sup>3</sup> 0,24	<b>1.900</b>			
	<b>DEG5801K</b>	piano in vetro - glass top	Kg. 45 M <sup>3</sup> 0,24		<b>1.400</b>		
	<b>DEG5901K</b>	piano in ceramica - ceramic top	Kg. 55 M <sup>3</sup> 0,24			<b>1.900</b>	
cm. 160 x 40 in. 62,99 x 29,52	<b>DEG5711K</b>	piano in legno - wooden top	Kg. 56 M <sup>3</sup> 0,25	<b>2.200</b>			
	<b>DEG5811K</b>	piano in vetro - glass top	Kg. 46 M <sup>3</sup> 0,25		<b>1.600</b>		
	<b>DEG5911K</b>	piano in ceramica - ceramic top	Kg. 56 M <sup>3</sup> 0,25			<b>2.250</b>	
cm. 200 x 40 in. 78,74 x 29,52	<b>DEG5721K</b>	piano in legno - wooden top	Kg. 59 M <sup>3</sup> 0,27	<b>2.400</b>			
	<b>DEG5821K</b>	piano in vetro - glass top	Kg. 49 M <sup>3</sup> 0,27		<b>1.850</b>		
	<b>DEG5921K</b>	piano in ceramica - ceramic top	Kg. 59 M <sup>3</sup> 0,27			<b>2.500</b>	
cm. 240 x 40 in. 94,48 x 29,52	<b>DEG5731K</b>	piano in legno - wooden top	Kg. 63 M <sup>3</sup> 0,30	<b>2.600</b>			
	<b>DEG5831K</b>	piano in vetro - glass top	Kg. 53 M <sup>3</sup> 0,30		<b>2.150</b>		
	<b>DEG5931K</b>	piano in ceramica - ceramic top	Kg. 63 M <sup>3</sup> 0,30			<b>2.700</b>	

piano in legno  
wooden top

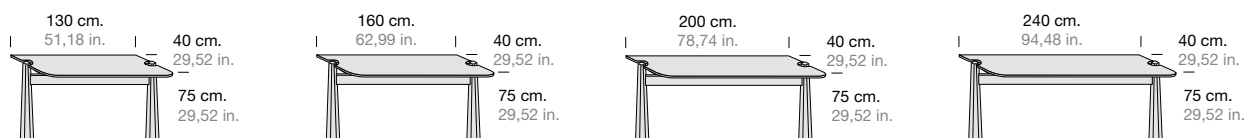

piano in vetro  
glass top

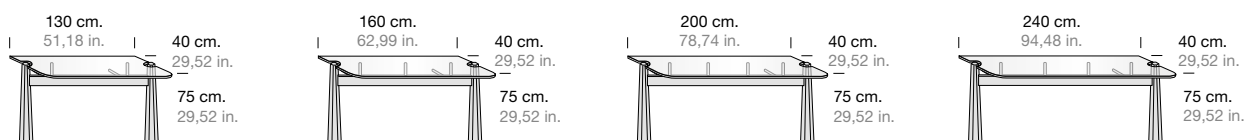

piano in ceramica  
ceramic top

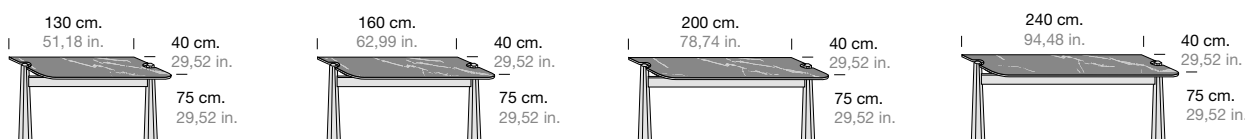

### CONSOLLE HOLE HOLE CONSOLE

AUTOPORTANTE  
SELF SUPPORTING

		PIANO IN LEGNO WOODEN TOP	PIANO IN LEGNO SPINATO HERRINGBONE WOODEN TOP	PIANO IN VETRO GLASS TOP	PIANO IN CERAMICA CERAMIC TOP	OPTIONAL GAMBA BRONZO O GRAFITE INCROCIATO BRONZO OR GRAFITE LEG
cm. 140 x 45 in. 55,12 x 17,71	<b>DEG5741K</b> piano ovale in legno - oval wooden top	Kg. 45 M³ 0,36	<b>1.900</b>			+ 500
	<b>DEG5841K</b> piano ovale in vetro - oval glass top	Kg. 45 M³ 0,36		<b>1.750</b>		+ 500
	<b>DEG5842K</b> piano rettangolare in vetro - rectangular glass top	Kg. 45 M³ 0,36		<b>1.750</b>		+ 500
	<b>DEG5941K</b> piano ovale in ceramica - ceramic oval top	Kg. 50 M³ 0,36			<b>2.200</b>	+ 500
	<b>DEG5942K</b> piano rettangolare in ceramica - ceramic rectangular top	Kg. 50 M³ 0,36			<b>2.200</b>	+ 500
cm. 160 x 45 in. 62,99 x 17,71	<b>DEG5751K</b> piano ovale in legno - oval wooden top	Kg. 48 M³ 0,38	<b>1.980</b>			+ 500
	<b>DEG5651K</b> piano ovale in legno spinato - herringbone oval wooden top	Kg. 48 M³ 0,38		<b>2.450</b>		+ 500
	<b>DEG5851K</b> piano ovale in vetro - oval glass top	Kg. 48 M³ 0,38		<b>1.850</b>		+ 500
	<b>DEG5852K</b> piano rettangolare in vetro - rectangular glass top	Kg. 48 M³ 0,38		<b>1.850</b>		+ 500
	<b>DEG5951K</b> piano ovale in ceramica - ceramic oval top	Kg. 53 M³ 0,38			<b>2.250</b>	+ 500
	<b>DEG5952K</b> piano rettangolare in ceramica - ceramic rectangular top	Kg. 53 M³ 0,38			<b>2.250</b>	+ 500

### piano ovale in legno oval wooden top



### piano ovale in legno spinato oval herringbone wooden top

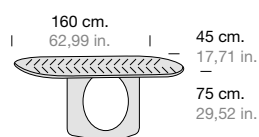

### piano ovale in vetro oval glass top



CONSOLLE  
CONSOLES

CONSOLLE HOLE  
HOLE CONSOLE

AUTOPORTANTE  
SELF SUPPORTING

		PIANO IN LEGNO WOODEN TOP	PIANO IN LEGNO SPINATO HERRINGBONE WOODEN TOP	PIANO IN VETRO GLASS TOP	PIANO IN CERAMICA CERAMIC TOP	OPTIONAL GAMBA BRONZO O GRAFITE INCROCIATO BRONZO OR GRAFITE LEG
cm. 180 x 45 in. 70,87 x 17,71	<b>DEG5761K</b> piano ovale in legno - oval wooden top	Kg. 55 M³ 0,40	<b>2.050</b>			+ 500
	<b>DEG5861K</b> piano ovale in vetro - oval glass top	Kg. 55 M³ 0,40		<b>1.900</b>		+ 500
	<b>DEG5862K</b> piano rettangolare in vetro - rectangular glass top	Kg. 55 M³ 0,40		<b>1.900</b>		+ 500
	<b>DEG5961K</b> piano ovale in ceramica - ceramic oval top	Kg. 60 M³ 0,40			<b>2.350</b>	+ 500
	<b>DEG5962K</b> piano rettangolare in ceramica - ceramic rectangular top	Kg. 60 M³ 0,40			<b>2.350</b>	+ 500
cm. 200 x 45 in. 78,74 x 17,71	<b>DEG5771K</b> piano ovale in legno - oval wooden top	Kg. 58 M³ 0,42	<b>2.150</b>			+ 500
	<b>DEG5871K</b> piano ovale in vetro - oval glass top	Kg. 58 M³ 0,42		<b>1.950</b>		+ 500
	<b>DEG5872K</b> piano rettangolare in vetro - rectangular glass top	Kg. 58 M³ 0,42		<b>1.950</b>		+ 500
	<b>DEG5971K</b> piano ovale in ceramica - ceramic oval top	Kg. 63 M³ 0,42			<b>2.450</b>	+ 500
	<b>DEG5972K</b> piano rettangolare in ceramica - ceramic rectangular top	Kg. 63 M³ 0,42			<b>2.450</b>	+ 500

piano rettangolare in vetro  
rectangular glass top

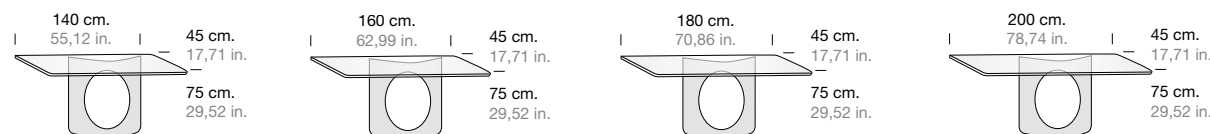

piano ovale in ceramica  
oval ceramic top

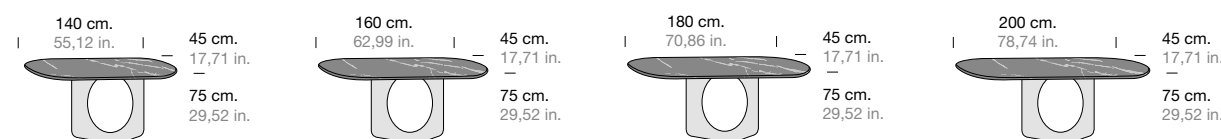

piano rettangolare in ceramica  
rectangular ceramic top

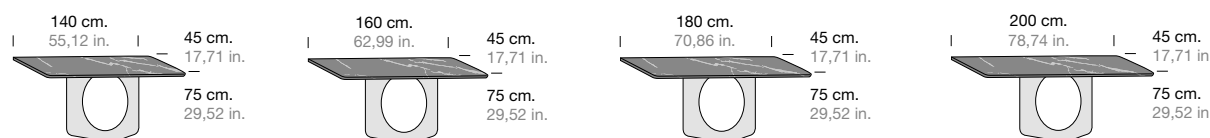

#### CONSOLE DOMINO DOMINO CONSOLE

1 CASSETTO  
1 DRAWER

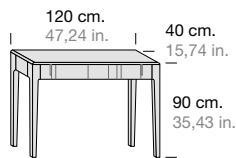

DOGA LEGNO LISCIA - MANIGLIA DOMINO  
PLAIN WOODEN SLAT - DOMINO HANDLE

CANALETTO
Doghe Multicolor - Multicolor slats

DOG5806K	OPTIONAL	
	DOGA SLAT DOGA RIGHE RIBBED SLAT	PIANO - TOP TOP MARMO MARBLE TOP
<b>1.850</b>		
<b>+ 5 %</b>	<b>+ 44</b>	<b>+ 1.000</b>
mc 0,50 - Kg 40		

1 CASSETTO  
1 DRAWER

**NEW**

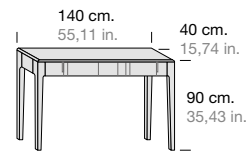

DOG5816K	OPTIONAL	
	DOGA SLAT DOGA RIGHE RIBBED SLAT	PIANO - TOP TOP MARMO MARBLE TOP
<b>2.150</b>		
<b>+ 5 %</b>	<b>+ 44</b>	<b>+ 1.200</b>
mc 0,60 - Kg 50		

#### MAGGIORAZIONI E RIDUZIONI SURCHARGES AND REDUCTIONS

RIDUZIONI SINGOLE  
SINGLE ADJUSTMENTS

LUNGHEZZA LENGTH	
PROFONDITÀ DEPTH	<b>+ 30%</b>
ALTEZZA HEIGHT	

RIDUZIONI COMBinate TRA LORO  
COMBINED ADJUSTMENTS

LUNGHEZZA + PROFONDITÀ LENGTH + DEPTH	<b>+ 40%</b>
--	--------------

PER ULTERIORI MODIFICHE  
RICHIEDERE PREVENTIVO  
FOR MODIFICATIONS  
ASK FOR AN ESTIMATE.

#### CONSOLE SHANGHAI SHANGHAI CONSOLE

1 CASSETTO  
1 DRAWER

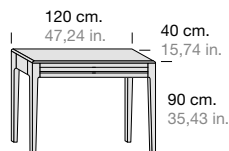

CANALETTO
-----------

SHG5801K	OPTIONAL	
	PIANO - TOP TOP CERAMICA CERAMIC TOP	
<b>1.750</b>		
<b>+ 5 %</b>	<b>+ 600</b>	
mc 0,50 - Kg 40		

#### TAVOLINI YORK YORK SMALL TABLES

**NEW**

PIANO IN LEGNO  
GAMBE VETRO TRASPARENTE  
WOODEN TOP  
TRANSPARENT GLASS FEET

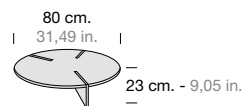

CANALETTO
-----------

DEG4550K	OPTIONAL
	GAMBE VETRO FUMÉ SMOKED GLASS FEET
<b>1.300</b>	
	<b>+ 250</b>
mc 0,18 - Kg 30	

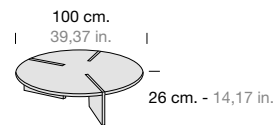

DEG4560K	OPTIONAL
	GAMBE VETRO FUMÉ SMOKED GLASS FEET
<b>1.450</b>	
	<b>+ 350</b>
mc 0,45 - Kg 40	

#### TAVOLINI YORK YORK SMALL TABLES

**NEW**

PIANO IN CERAMICA  
GAMBE VETRO TRASPARENTE  
CERAMIC TOP  
TRANSPARENT GLASS FEET

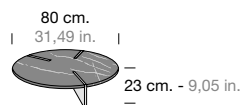

CANALETTO
-----------

DEG4650K	OPTIONAL
	GAMBE VETRO FUMÉ SMOKED GLASS FEET
<b>1.700</b>	
	<b>+ 250</b>
mc 0,18 - Kg 30	

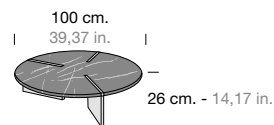

DEG4660K	OPTIONAL
	GAMBE VETRO FUMÉ SMOKED GLASS FEET
<b>1.800</b>	
	<b>+ 350</b>
mc 0,45 - Kg 40	

TAVOLINI  
SMALL TABLES

TAVOLINI YORK  
YORK SMALL TABLES

NEW

COPPIA DI TAVOLINI  
COUPLE OF SMALL TABLES

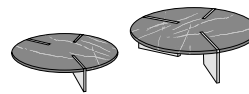
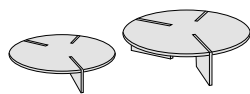

	DEG4590K	OPTIONAL	DEG4690K	OPTIONAL
		GAMBE VETRO FUMÉ SMOKED GLASS FEET		GAMBE VETRO FUMÉ SMOKED GLASS FEET
<b>CANALETTO</b>	<b>2.750</b>	<b>+ 600</b>	<b>3.500</b>	<b>+ 600</b>
	mc 0,63 - Kg 70		mc 0,63 - Kg 70	

MAGGIORAZIONI E RIDUZIONI  
SURCHARGES AND REDUCTIONS

RIDUZIONI SINGOLE  
SINGLE ADJUSTMENTS

LUNGHEZZA LENGTH	
PROFONDITÀ DEPTH	+ 30%
ALTEZZA HEIGHT	

RIDUZIONI COMBinate TRA LORO  
COMBINED ADJUSTMENTS

LUNGHEZZA + PROFONDITÀ LENGTH + DEPTH	+ 40%
--	-------

PER ULTERIORI MODIFICHE  
RICHIEDERE PREVENTIVO  
FOR MODIFICATIONS  
ASK FOR AN ESTIMATE.

TAVOLINO A TU PER TU  
A TU PER TU COFFEE TABLES

NEW

PIANO IN LEGNO E CERAMICA  
GAMBE VETRO TRASPARENTE  
WOODEN AND CERAMIC TOP  
TRANSPARENT GLASS FEETS

PIANO IN LEGNO  
GAMBE VETRO  
TRASPARENTE  
WOODEN TOP  
TRANSPARENT  
GLASS FEETS

PIANO IN VETRO  
GAMBE VETRO  
TRASPARENTE  
GLASS TOP  
TRANSPARENT  
GLASS FEETS

PIANO IN CERAMICA  
GAMBE VETRO  
TRASPARENTE  
CERAMIC TOP  
TRANSPARENT  
GLASS FEETS

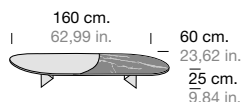

	DEG4570K	OPTIONAL	DEG4580K	DEG4680K	DEG4780K	OPTIONAL
		GAMBE VETRO FUMÉ SMOKED GLASS FEET				GAMBE VETRO FUMÉ SMOKED GLASS FEET
<b>CANALETTO</b>	<b>2.190</b>	<b>+ 250</b>	<b>1.900</b>	<b>1.900</b>	<b>2.300</b>	<b>+ 250</b>
	mc 0,69 - Kg 30		mc 0,69 - Kg 30	mc 0,69 - Kg 30	mc 0,69 - Kg 30	

TAVOLINI SHANGHAI  
SHANGHAI SMALL TABLES

TAVOLINO QUADRATO  
SQUARE TABLE

TAVOLINO QUADRATO  
SQUARE TABLE

TAVOLINO RETTANGOLARE  
RECTANGULAR TABLE

TAVOLINO RETTANGOLARE  
RECTANGULAR TABLE

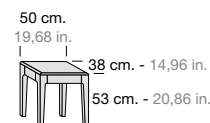
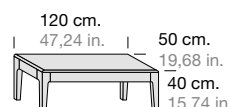
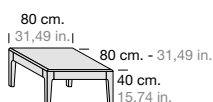
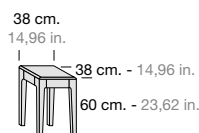

	SHG6001K	OPTIONAL	SHG6011K	OPTIONAL	SHG6021K	OPTIONAL	SHG3301K	OPTIONAL
		PIANO - TOP CERAMICA CERAMIC		PIANO - TOP CERAMICA CERAMIC		PIANO - TOP CERAMICA CERAMIC		PIANO - TOP CERAMICA CERAMIC
<b>CANALETTO</b>	<b>784</b>	<b>+ 250</b>	<b>1.180</b>	<b>+ 700</b>	<b>1.180</b>	<b>+ 700</b>	<b>784</b>	<b>+ 300</b>
	mc 0,10 Kg 8		mc 0,29 Kg 15		mc 0,27 Kg 15		mc 0,12 Kg 10	

TAVOLINI DOMINO  
DOMINO SMALL TABLES

TAVOLINO QUADRATO  
SQUARE TABLE

TAVOLINO QUADRATO  
SQUARE TABLE

TAVOLINO RETTANGOLARE  
RECTANGULAR TABLE

TAVOLINO RETTANGOLARE  
RECTANGULAR TABLE

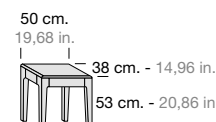
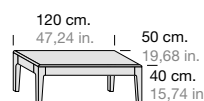
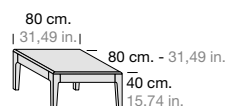
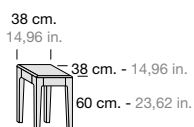

	DOG6811K	OPTIONAL	DOG6801K	OPTIONAL	DOG6821K	OPTIONAL	DON3301K	OPTIONAL
		PIANO - TOP MARMO MARBLE		PIANO - TOP MARMO MARBLE		PIANO - TOP MARMO MARBLE		PIANO - TOP MARMO MARBLE
<b>CANALETTO</b>	<b>832</b>	<b>+ 500</b>	<b>1.221</b>	<b>+ 1.100</b>	<b>1.345</b>	<b>+ 1.100</b>	<b>832</b>	<b>+ 500</b>
	mc 0,10 Kg 8		mc 0,29 Kg 15		mc 0,27 Kg 15		mc 0,12 Kg 10	

# GIORNO - DAY

## SCRITTOIO - SCRIVANIA - POLTRONE

### WRITING DESK - DESK - ARMCHAIRS

#### SCRITTOIO DOMINO DA PARETE WALL WRITING DESK DOMINO

1 CASSETTO  
1-DRAWER

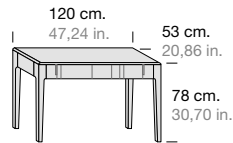

DOGA LEGNO LISCIA, MANIGLIA DOMINO  
PLAIN WOODEN SLAT, DOMINO HANDLE

	DOG5906K	OPTIONAL		
		DOGA SLAT DOGA RIGHE RIBBED SLAT	PIANO - TOP TOP MARMO MARBLE TOP	TOP PELLE LEATHER TOP
CANALETTO	<b>1.947</b>			
Doghe Multicolor - Multicolor slats	<b>+ 5%</b>	<b>+ 44</b>	<b>+ 1.000</b>	<b>+ 700</b>
	mc 0,57 - Kg 45			

#### SCRITTOIO SHANGHAI WRITING DESK SHANGHAI

1 CASSETTO  
1-DRAWER

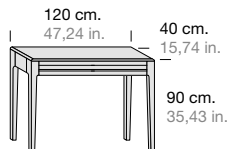

MANIGLIA INTEGRATA IN LEGNO  
INTEGRATED WOODEN HANDLE

	SHG5901K	OPTIONAL	
		PIANO - TOP TOP CERAMICA CERAMIC TOP	TOP PELLE LEATHER TOP
CANALETTO	<b>1.850</b>		
		<b>+ 600</b>	<b>+ 700</b>
	mc 0,57 - Kg 45		

#### SCRIVANIA DOMINO DOMINO DESK

VERSIONE DRITTA 4 CASSETTI CON PIANO IN PELLE  
STRAIGHT VERSION DESK WITH 4 DRAWERS, LEATHER TOP

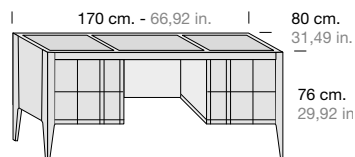

DOGA LEGNO LISCIA, MANIGLIA DOMINO  
PLAIN WOODEN SLAT, DOMINO HANDLE

	DOG4511K	OPTIONAL	
		MULTIPRESA MULTIPLE SOCKET	RICARICA WIRELESS WIRELESS CHARGING
CANALETTO	<b>7.300</b>		
Doghe Multicolor - Multicolor slats	<b>+ 10%</b>	<b>+ 755</b>	<b>+ 384</b>
	mc 1,30 - Kg 115		

#### SCRIVANIA DOMINO DOMINO DESK

VERSIONE CURVA 4 CASSETTI CON PIANO IN PELLE  
CURVED VERSION DESK WITH 4 DRAWERS, LEATHER TOP

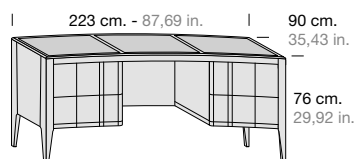

DOGA LEGNO LISCIA, MANIGLIA DOMINO  
PLAIN WOODEN SLAT, DOMINO HANDLE

	DOG4501K	OPTIONAL	
		MULTIPRESA MULTIPLE SOCKET	RICARICA WIRELESS WIRELESS CHARGING
CANALETTO	<b>9.450</b>		
Doghe Multicolor - Multicolor slats	<b>+ 10%</b>	<b>+ 755</b>	<b>+ 384</b>
	mc 2,44 - Kg 143		

#### MAGGIORAZIONI E RIDUZIONI SURCHARGES AND REDUCTIONS

RIDUZIONI SINGOLE  
SINGLE ADJUSTMENTS

LUNGHEZZA LENGTH	
PROFONDITÀ DEPTH	<b>+ 30%</b>
ALTEZZA HEIGHT	

RIDUZIONI COMBinate TRA LORO  
COMBINED ADJUSTMENTS

LUNGHEZZA + PROFONDITÀ LENGTH + DEPTH	<b>+ 40%</b>
--	--------------

PER ULTERIORI MODIFICHE  
RICHIEDERE PREVENTIVO  
FOR MODIFICATIONS  
ASK FOR AN ESTIMATE.



**POLTRONE  
ARMCHAIRS**

**POLTRONA GOTHAM**

TESSUTO CLIENTE  
MT. LINEARI NECESSARI: 4,50

**GOTHAM ARMCHAIR**

CUSTOMER'S FABRIC  
METERS LINEAR NEEDED: 4,50

IMBOTTITA GIREVOLE  
PADDED SWIVEL

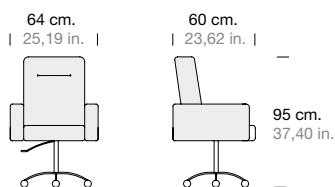

BASAMENTO METALLO IN FINITURA NICKEL O BRONZO  
METAL BASE IN NICKEL OR BRONZE FINISH

CML1942K			
CAT. A	CAT. B	CAT. C	CAT. COM
ECOPELLE/ECONABUK FAUX LEATHER/ECONABUK	LINO/VELLUTO/BOUCLÉ LINEN/VELVET/BOUCLÉ	PELLE LEATHER	TESSUTO CLIENTE C.O.M. CUSTOMER FABRIC
<b>3.008</b>	<b>3.103</b>	<b>4.660</b>	<b>2.700</b>

mc 0,44 – Kg 30

**POLTRONA DOMINO**

TESSUTO CLIENTE  
MT. LINEARI NECESSARI: 3,50

**DOMINO ARMCHAIR**

CUSTOMER'S FABRIC  
METERS LINEAR NEEDED: 3,50

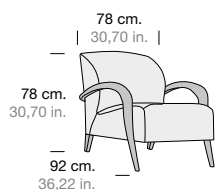

DON9101K			
CAT. A	CAT. B	CAT. C	CAT. COM
ECOPELLE/ECONABUK FAUX LEATHER/ECONABUK	LINO/VELLUTO/BOUCLÉ LINEN/VELVET/BOUCLÉ	PELLE LEATHER	TESSUTO CLIENTE C.O.M. CUSTOMER FABRIC
<b>2.200</b>	<b>2.400</b>	<b>3.300</b>	<b>1.950</b>

mc 0,64 – Kg 45

**MAGGIORAZIONI E RIDUZIONI  
SURCHARGES AND REDUCTIONS**

**RIDUZIONI SINGOLE  
SINGLE ADJUSTMENTS**

LUNGHEZZA LENGTH	
PROFONDITÀ DEPTH	<b>+ 30%</b>
ALTEZZA HEIGHT	

**RIDUZIONI COMBinate TRA LORO  
COMBINED ADJUSTMENTS**

LUNGHEZZA + PROFONDITÀ LENGTH + DEPTH	<b>+ 40%</b>
--	--------------

PER ULTERIORI MODIFICHE  
RICHIEDERE PREVENTIVO  
FOR MODIFICATIONS  
ASK FOR AN ESTIMATE.

#### COMODINO OPERA

#### OPERA BEDSIDE TABLE

**NEW**

COMODINO 1 CASSETTO BASE METALLO  
BEDSIDE TABLE WITH 1 DRAWER AND METAL BASE



	DEN7101K	OPTIONAL	
		ACS7425C TOP CERAMICA CERAMIC TOP	BASE METALLO LAVA O RAME METAL BASE LAVA OR RAME
CANALETTO	1.800	+ 250	+ 350
	mc 0,12 - Kg 35		

#### COMÒ OPERA OPERA DRESSER

**NEW**

COMÒ 2 CASSETTI  
DRESSER WITH 2 DRAWERS

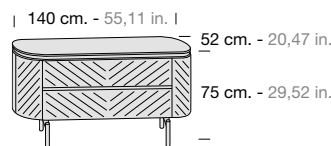

	DEN6101K	OPTIONAL	
		ACS7425C TOP CERAMICA CERAMIC TOP	BASE METALLO LAVA O RAME METAL BASE LAVA OR RAME
CANALETTO	3.300	+ 900	+ 200
	mc 0,65 - Kg 70		

#### COMODINO HARIBO HARIBO BEDSIDE TABLE

**NEW**

COMODINO 1 CASSETTO BASE LEGNO  
BEDSIDE TABLE WITH 1 DRAWER AND WOODEN BASE



COMODINO 2 CASSETTI BASE LEGNO  
BEDSIDE TABLE WITH 2 DRAWERS AND WOODEN BASE



	DEN7111K	OPTIONAL	DEN7121K	OPTIONAL
		ACS7425C TOP CERAMICA CERAMIC TOP		ACS7425C TOP CERAMICA CERAMIC TOP
CANALETTO	1.800	+ 250	2.450	+ 250
	mc 0,12 - Kg 35		mc 0,12 - Kg 40	

#### COMODINO CANNAREGIO CANNAREGIO BEDSIDE TABLE

**NEW**

COMODINO 2 CASSETTI  
BEDSIDE TABLE WITH 2 DRAWERS

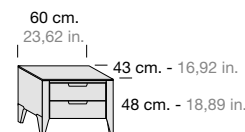

MANIGLIA IN METALLO COLORE METAL GRAY  
METAL HANDLE IN "METAL GRAY" COLOUR

	DON7031K	OPTIONAL	
		ACS7201C TOP CERAMICA CERAMIC TOP	
CANALETTO	850	+ 150	
	mc 0,14 - Kg 40		

#### MAGGIORAZIONI E RIDUZIONI SURCHARGES AND REDUCTIONS

RIDUZIONI SINGOLE  
SINGLE ADJUSTMENTS

LUNGHEZZA LENGTH	+ 30%
PROFONDITÀ DEPTH	
ALTEZZA HEIGHT	

RIDUZIONI COMBinate TRA LORO  
COMBINED ADJUSTMENTS

LUNGHEZZA + PROFONDITÀ LENGTH + DEPTH	+ 40%
--	-------

PER ULTERIORI MODIFICHE  
RICHIEDERE PREVENTIVO  
FOR MODIFICATIONS  
ASK FOR AN ESTIMATE.

**COMÒ - COMODINI**  
**CHEST OF DRAWERS - NIGHT TABLES**

**COMÒ CANNAREGIO**  
**CANNAREGIO DRESSER**

**NEW**

COMÒ 3 CASSETTI  
DRESSER WITH 3 DRAWERS

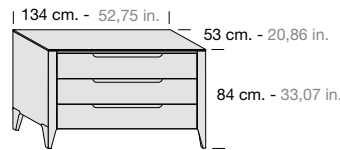

MANIGLIA IN METALLO COLORE METAL GRAY  
METAL HANDLE IN "METAL GRAY" COLOUR

	DON6031K	OPTIONAL		
		ACS7201C		
		TOP CERAMICA		
		CERAMIC TOP		
CANALETTO	<b>1.850</b>	<b>+ 420</b>		
	mc 0,69 – Kg 70			

**COMODINO BOOK**  
**BOOK**  
**BEDSIDE TABLE**

**NEW**

COMODINO 2 CASSETTI  
BEDSIDE TABLE WITH 2 DRAWERS

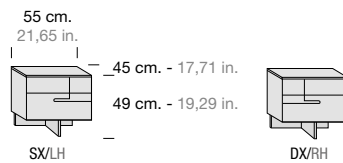

FRONTALI IN LEGNO, BASE IN VETRO, OPZIONALE: LUCE LED SU BASE CON PULSANTE ACCENSIONE COMANDATA  
WOODEN FRONT, GLASS BASE, OPTIONAL: LED LIGHT ON BASE WITH CONTROLLED IGNITION BUTTON

	SX - CUN7142K	OPTIONAL			
		ACS7241C	ACS7019K	ACS7010C	ACS7010C
		TOP CERAMICA	LUCE LED SU BASE	KIT APP	KIT PULSANTE O TELECOMANDO
		CERAMIC TOP	LED LIGHT ON BASE	APP KIT	SWITCH OR REMOTE CONTROL KIT
CANALETTO	<b>1.480</b>	<b>+ 270</b>	<b>+ 200</b>	<b>+ 450</b>	<b>+ 550</b>
	mc 0,14 – Kg 35				

**COMODINO BOOK**  
**BOOK**  
**BEDSIDE TABLE**

**NEW**

COMODINO 2 CASSETTI  
BEDSIDE TABLE WITH 2 DRAWERS

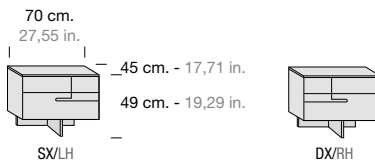

FRONTALI IN LEGNO, BASE IN VETRO, OPZIONALE: LUCE LED SU BASE CON PULSANTE ACCENSIONE COMANDATA  
WOODEN FRONT, GLASS BASE, OPTIONAL: LED LIGHT ON BASE WITH CONTROLLED IGNITION BUTTON

	SX - CUN7132K	OPTIONAL			
		ACS7241C	ACS7019K	ACS7010C	ACS7010C
		TOP CERAMICA	LUCE LED SU BASE	KIT APP	KIT PULSANTE O TELECOMANDO
		CERAMIC TOP	LED LIGHT ON BASE	APP KIT	SWITCH OR REMOTE CONTROL KIT
CANALETTO	<b>1.780</b>	<b>+ 350</b>	<b>+ 200</b>	<b>+ 450</b>	<b>+ 550</b>
	mc 0,18 – Kg 50				

**COMÒ BOOK**  
**BOOK DRESSER**

**NEW**

COMÒ 3 CASSETTI  
DRESSER WITH 3 DRAWERS

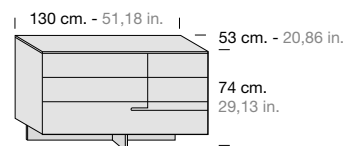

FRONTALI IN LEGNO, BASE IN VETRO E LEGNO, OPZIONALE: LUCE LED SU BASE CON PULSANTE ACCENSIONE COMANDATA  
WOODEN FRONT, WOODEN AND GLASS BASE, OPTIONAL: LED LIGHT ON BASE WITH CONTROLLED IGNITION BUTTON

	CUN6131K	OPTIONAL			
		ACS7261C	ACS7019K	ACS7010C	ACS7010C
		TOP CERAMICA	LUCE LED SU BASE	KIT APP	KIT PULSANTE O TELECOMANDO
		CERAMIC TOP	LED LIGHT ON BASE	APP KIT	SWITCH OR REMOTE CONTROL KIT
CANALETTO	<b>3.450</b>	<b>+ 750</b>	<b>+ 250</b>	<b>+ 450</b>	<b>+ 550</b>
	mc 0,61 – Kg 70				

**MAGGIORAZIONI E RIDUZIONI**  
SURCHARGES AND REDUCTIONS

RIDUZIONI SINGOLE  
SINGLE ADJUSTMENTS

LUNGHEZZA LENGTH	
PROFONDITÀ DEPTH	<b>+ 30%</b>
ALTEZZA HEIGHT	

RIDUZIONI COMBinate TRA LORO  
COMBINED ADJUSTMENTS

LUNGHEZZA + PROFONDITÀ LENGTH + DEPTH	<b>+ 40%</b>
--	--------------

PER ULTERIORI MODIFICHE  
RICHIEDERE PREVENTIVO  
FOR MODIFICATIONS  
ASK FOR AN ESTIMATE.

#### COMODINO YORK

#### YORK BEDSIDE TABLE

COMODINO 1 CASSETTO  
BEDSIDE TABLE WITH 1 DRAWER

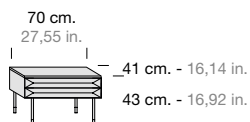

FRONTALI IN LEGNO, PIEDI IN METALLO  
WOODEN FRONT, METAL FEET

	DEN7701K	OPTIONAL	
		ACS7291C TOP CERAMICA CERAMIC TOP	
CANALETTO	1.150	+ 250	
	mc 0,15 – Kg 25		

#### MAGGIORAZIONI E RIDUZIONI SURCHARGES AND REDUCTIONS

RIDUZIONI SINGOLE  
SINGLE ADJUSTMENTS

LUNGHEZZA LENGTH	+ 30%
PROFONDITÀ DEPTH	
ALTEZZA HEIGHT	

RIDUZIONI COMBinate TRA LORO  
COMBINED ADJUSTMENTS

LUNGHEZZA + PROFONDITÀ LENGTH + DEPTH	+ 40%
--	-------

PER ULTERIORI MODIFICHE  
RICHIEDERE PREVENTIVO  
FOR MODIFICATIONS  
ASK FOR AN ESTIMATE.

#### COMÒ YORK YORK DRESSER

COMÒ 3 CASSETTI  
DRESSER WITH 3 DRAWERS

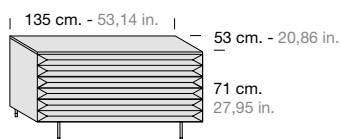

FRONTALI IN LEGNO, PIEDI IN METALLO  
WOODEN FRONT, METAL FEET

	DEN6001K	OPTIONAL	
		ACS7211C TOP CERAMICA CERAMIC TOP	
CANALETTO	2.980	+ 750	
	mc 0,66 – Kg 80		

#### COMODINO MODI MODI BEDSIDE TABLE

COMODINO 2 CASSETTI  
BEDSIDE TABLE WITH 2 DRAWERS



FRONTALI IN LEGNO, BASE IN LEGNO  
WOODEN FRONT, WOODEN BASE

	SX - DEN7022K	OPTIONAL	SX - DEN7012K	OPTIONAL
		ACS7241C TOP CERAMICA CERAMIC TOP		ACS7251C TOP CERAMICA CERAMIC TOP
CANALETTO	1.350	+ 270	1.785	+ 350
	mc 0,15 – Kg 25		mc 0,18 – Kg 35	

#### COMÒ MODI MODI DRESSER

COMÒ 3 CASSETTI  
DRESSER WITH 3 DRAWERS

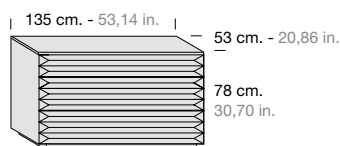

FRONTALI IN LEGNO, BASE IN LEGNO  
WOODEN FRONT, WOODEN BASE

	DEN6021K	OPTIONAL
		ACS7261C TOP CERAMICA CERAMIC TOP
CANALETTO	2.980	+ 750
	mc 0,66 – Kg 80	

COMÒ 6 CASSETTI  
DRESSER WITH 6 DRAWERS

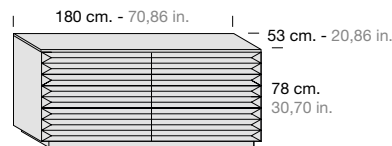

FRONTALI IN LEGNO, BASE IN LEGNO  
WOODEN FRONT, WOODEN BASE

	DEN60111K	OPTIONAL
		ACS7271C TOP CERAMICA CERAMIC TOP
CANALETTO	4.960	+ 900
	mc 0,88 – Kg 100	

**NEW**

**COMÒ - COMODINI**  
**CHEST OF DRAWERS - NIGHT TABLES**

**COMODINO**  
**SHANGHAI**  
**SHANGHAI**  
**BEDSIDE TABLE**

COMODINO 2 CASSETTI  
BEDSIDE TABLE WITH 2 DRAWERS

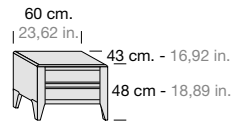

MANIGLIA INTEGRATA IN LEGNO  
INTEGRATED WOODEN HANDLE

	SHN7001K	OPTIONAL		
		ACS7201C		
		TOP CERAMICA		
		CERAMIC TOP		
<b>CANALETTO</b>	<b>950</b>	<b>+ 150</b>		
<b>Bicolore / Bicolor</b>	<b>+ 5 %</b>			
	mc 0,14 – Kg 40			

**COMÒ**  
**SHANGHAI**  
**SHANGHAI**  
**CHEST OF DRAWERS**

COMÒ 3 CASSETTI  
3-DRAWER CHEST

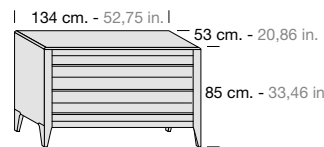

MANIGLIA INTEGRATA IN LEGNO  
INTEGRATED WOODEN HANDLE

	SHN6001K	OPTIONAL		
		ACS7211C		
		TOP CERAMICA		
		CERAMIC TOP		
<b>CANALETTO</b>	<b>2.200</b>	<b>+ 420</b>		
<b>Bicolore / Bicolor</b>	<b>+ 5 %</b>			
	mc 0,69 – Kg 70			

**COMODINO**  
**DOMINO**  
**DOMINO**  
**BEDSIDE TABLE**

COMODINO 2 CASSETTI  
BEDSIDE TABLE WITH 2 DRAWERS

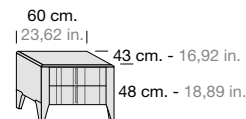

DOGA LEGNO LISCIA - MANIGLIA DOMINO  
PLAIN WOODEN SLAT - DOMINO HANDLE

	DON7006K	OPTIONAL		
		DOGA RIGHE	DOGA SLAT	TOP MARMO
		RIBBED SLAT	WOODEN SQUARE SLAT	MARBLE TOP
<b>CANALETTO</b>	<b>1.250</b>	<b>+ 65</b>	<b>+ 104</b>	<b>+ 750</b>
<b>Doghe Multicolor - Multicolor slats</b>	<b>+ 5 %</b>			
	mc 0,14 – Kg 40			

**DOMINO**  
**COMÒ**  
**DOMINO**  
**CHEST OF DRAWERS**

COMÒ 3 CASSETTI  
3-DRAWER CHEST

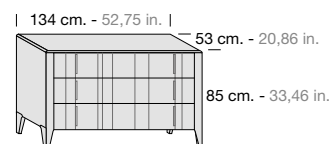

DOGA LEGNO LISCIA - MANIGLIA DOMINO  
PLAIN WOODEN SLAT - DOMINO HANDLE

	DON6006K	OPTIONAL		
		DOGA RIGHE	DOGA SLAT	TOP MARMO
		RIBBED SLAT	WOODEN SQUARE SLAT	MARBLE TOP
<b>CANALETTO</b>	<b>2.490</b>	<b>+ 96</b>	<b>+ 133</b>	<b>+ 1200</b>
<b>Doghe Multicolor - Multicolor slats</b>	<b>+ 5 %</b>			
	mc 0,69 – Kg 70			

**MAGGIORAZIONI E RIDUZIONI**  
**SURCHARGES AND REDUCTIONS**

RIDUZIONI SINGOLE  
SINGLE ADJUSTMENTS

LUNGHEZZA LENGTH	
PROFONDITÀ DEPTH	<b>+ 30%</b>
ALTEZZA HEIGHT	

RIDUZIONI COMBinate TRA LORO  
COMBINED ADJUSTMENTS

LUNGHEZZA + PROFONDITÀ LENGTH + DEPTH	<b>+ 40%</b>
--	--------------

PER ULTERIORI MODIFICHE  
RICHIEDERE PREVENTIVO  
FOR MODIFICATIONS  
ASK FOR AN ESTIMATE.

# NOTTE - NIGHT

## COMÒ - COMODINI - CASSETTIERE

### CHEST OF DRAWERS - NIGHT TABLES - DRAWER UNITS

#### COMODINO MEMPHIS

#### MEMPHIS BEDSIDE TABLE

COMODINO 2 CASSETTI  
BEDSIDE TABLE WITH 2 DRAWERS

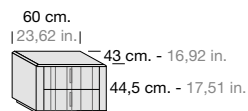

DOGA LEGNO LISCIA - MANIGLIA DOMINO  
PLAIN WOODEN SLAT - DOMINO HANDLE

DON7706K	OPTIONAL		
	DOGA RIGHE RIBBED SLAT	DOGA SLAT DOGA QUADRO LEGNO WOODEN SQUARE SLAT	TOP MARMO MARBLE TOP
<b>1.250</b>			
<b>+ 5 %</b>	<b>+ 65</b>	<b>+ 104</b>	<b>+ 750</b>
mc 0,14 - Kg 40			

#### COMÒ MEMPHIS

#### MEMPHIS CHEST OF DRAWERS

COMÒ 3 CASSETTI  
3-DRAWER CHEST

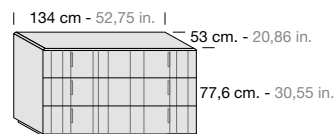

DOGA LEGNO LISCIA - MANIGLIA DOMINO  
PLAIN WOODEN SLAT - DOMINO HANDLE

CANALETTO	DON6606K	OPTIONAL		
		DOGA RIGHE RIBBED SLAT	DOGA SLAT DOGA QUADRO LEGNO WOODEN SQUARE SLAT	TOP MARMO MARBLE TOP
<b>2.750</b>				
<b>+ 5 %</b>	<b>+ 96</b>	<b>+ 133</b>	<b>+ 1200</b>	
mc 0,69 - Kg 70				

#### CASSETTIERA SHANGHAI

#### SHANGHAI DRAWER UNIT

CASSETTIERA 5 CASSETTI  
5-DRAWER UNIT

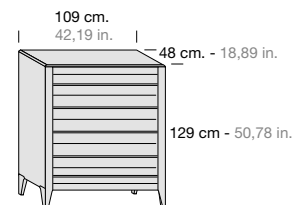

MANIGLIA INTEGRATA IN LEGNO  
INTEGRATED WOODEN HANDLE

CANALETTO	SHN6041K	OPTIONAL		
		ACS7281C TOP CERAMICA CERAMIC TOP		
<b>3.250</b>				
<b>+ 5 %</b>	<b>+ 350</b>			
mc 0,77 - Kg 85				

#### CASSETTIERA DOMINO

#### DOMINO DRAWER UNIT

CASSETTIERA 5 CASSETTI  
5-DRAWER UNIT

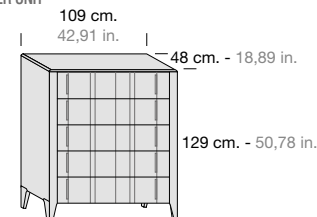

DOGA LEGNO LISCIA - MANIGLIA DOMINO  
PLAIN WOODEN SLAT - DOMINO HANDLE

CANALETTO	DON6516K	OPTIONAL		
		DOGA RIGHE RIBBED SLAT	DOGA SLAT DOGA QUADRO LEGNO WOODEN SQUARE SLAT	TOP MARMO MARBLE TOP
<b>3.580</b>				
<b>+ 5 %</b>	<b>+ 144</b>	<b>+ 193</b>	<b>+ 800</b>	
mc 0,77 - Kg 85				

#### MAGGIORAZIONI E RIDUZIONI SURCHARGES AND REDUCTIONS

RIDUZIONI SINGOLE  
SINGLE ADJUSTMENTS

LUNGHEZZA LENGTH	
PROFONDITÀ DEPTH	<b>+ 30%</b>
ALTEZZA HEIGHT	

RIDUZIONI COMBinate TRA LORO  
COMBINED ADJUSTMENTS

LUNGHEZZA + PROFONDITÀ LENGTH + DEPTH	<b>+ 40%</b>
--	--------------

PER ULTERIORI MODIFICHE  
RICHIEDERE PREVENTIVO  
FOR MODIFICATIONS  
ASK FOR AN ESTIMATE.

VANITY - POLTRONE - POUFF

VANITY - AMRCHAIR - POUFF

VANITY SHANGHAI SHANGHAI VANITY

VANITY 1 CASSETTO E SPECCHIO  
VANITY WITH 1 DRAWER AND MIRROR

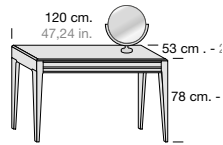

MANIGLIA INTEGRATA IN LEGNO, SPECCHIERA IN METALLO  
INTEGRATED WOODEN HANDLE, METAL MIRROR

	SHN7841K	OPTIONAL	
		FRONTALE - FRONT	
		TOP CERAMICA CERAMIC TOP	SPECCHIO FUMÉ / GOLD / SILVER SMOKED MIRROR / GOLD / SILVER
CANALETTO	<b>2.360</b>		
Bicolore / Bicolor	<b>+ 5 %</b>	<b>+ 650</b>	<b>+ 285</b>
	mc 0,50 - Kg 30		

VANITY DOMINO DOMINO VANITY

VANITY 1 CASSETTO E SPECCHIO  
VANITY WITH 1 DRAWER AND MIRROR

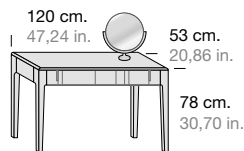

MANIGLIA DOMINO, SPECCHIERA IN METALLO  
DOMINO HANDLE, METAL MIRROR

	DON7801K	OPTIONAL	
		TOP MARMO MARBLE TOP	
CANALETTO	<b>2.580</b>		
Bicolore / Bicolor	<b>+ 5 %</b>	<b>+ 1.100</b>	
	mc 0,50 - Kg 30		

POLTRONA DOMINO

TESSUTO CLIENTE  
MT. LINEARI NECESSARI: 3,50

DOMINO ARMCHAIR

CUSTOMER'S FABRIC  
METERS LINEAR NEEDED: 3,50

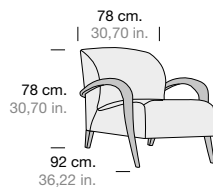

DON9101K			
CAT. A	CAT. B	CAT. C	CAT. COM
ECOPELLE/ECONABUK FAUX LEATHER/ECONABUK	LINOVELLUTO/BOUCLÉ LINENVELVET/BOUCLÉ	PELLE LEATHER	TESSUTO CLIENTE C.O.M. CUSTOMER FABRIC
<b>2.200</b>	<b>2.400</b>	<b>3.300</b>	<b>1.950</b>
mc 0,64 - Kg 45			

POUF DOMINO

TESSUTO CLIENTE  
MT. LINEARI NECESSARI: 2,00

DOMINO POUF

CUSTOMER'S FABRIC  
METERS LINEAR NEEDED: 2,00

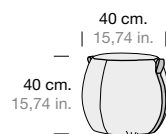

MANIGLIE IN CUIOIO  
LEATHER HANDLE

CML3001K			
CAT. A	CAT. B	CAT. C	CAT. COM
ECOPELLE/ECONABUK FAUX LEATHER/ECONABUK	LINOVELLUTO/BOUCLÉ LINENVELVET/BOUCLÉ	PELLE LEATHER	TESSUTO CLIENTE C.O.M. CUSTOMER FABRIC
<b>1.100</b>	<b>1.200</b>	<b>1.500</b>	<b>950</b>

mc 0,08 - Kg 10



MANIGLIE IN CUIOIO  
LEATHER HANDLE

CML3021K			
CAT. A	CAT. B	CAT. C	CAT. COM
ECOPELLE/ECONABUK FAUX LEATHER/ECONABUK	LINOVELLUTO/BOUCLÉ LINENVELVET/BOUCLÉ	PELLE LEATHER	TESSUTO CLIENTE C.O.M. CUSTOMER FABRIC
<b>1.250</b>	<b>1.300</b>	<b>1.700</b>	<b>1.050</b>

mc 0,12 - Kg 12

MAGGIORAZIONI E RIDUZIONI  
SURCHARGES AND REDUCTIONS

RIDUZIONI SINGOLE  
SINGLE ADJUSTMENTS

LUNGHEZZA LENGTH	<b>+ 30%</b>
PROFONDITÀ DEPTH	
ALTEZZA HEIGHT	

RIDUZIONI COMBinate TRA LORO  
COMBINED ADJUSTMENTS

LUNGHEZZA + PROFONDITÀ LENGTH + DEPTH	<b>+ 40%</b>
--	--------------

PER ULTERIORI MODIFICHE  
RICHIEDERE PREVENTIVO  
FOR MODIFICATIONS  
ASK FOR AN ESTIMATE.

## POUFF - PANCHETTE

## POUFF - BENCHES

### POUF DOMINO

TESSUTO CLIENTE

MT. LINEARI NECESSARI: 2,20

### DOMINO POUF

CUSTOMER'S FABRIC

METERS LINEAR NEEDED: 2,20

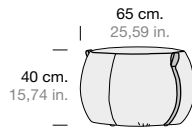

MANIGLIE IN CUIO  
LEATHER HANDLE

#### CML3011K

CAT. A	CAT. B	CAT. C	CAT. COM
ECOPELLE/ECONABUK FAUX LEATHER/ECONABUK	LINO/VELLUTO/BOUCLÉ LINEN/VELVET/BOUCLÉ	PELLE LEATHER	TESSUTO CLIENTE C.O.M. CUSTOMER FABRIC
<b>1.450</b>	<b>1.540</b>	<b>2.400</b>	<b>1.200</b>

mc 0,21 – Kg 14

### PANCHETTA METRÒ

TESSUTO CLIENTE

MT. LINEARI NECESSARI: 3,00

### METRÒ BENCH

CUSTOMER'S FABRIC

METERS LINEAR NEEDED: 3,00

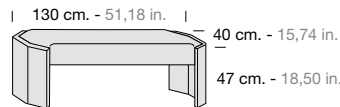

NEW

#### CML2021K

CAT. A	CAT. B	CAT. C	CAT. COM
ECOPELLE/ECONABUK FAUX LEATHER/ECONABUK	LINO/VELLUTO/BOUCLÉ LINEN/VELVET/BOUCLÉ	PELLE LEATHER	TESSUTO CLIENTE C.O.M. CUSTOMER FABRIC
<b>1.060</b>	<b>1.107</b>	<b>1.550</b>	<b>967</b>

mc 0,25 – Kg 20

### SGABELLO METRÒ

TESSUTO CLIENTE

MT. LINEARI NECESSARI: 2,00

### METRÒ STOOL

CUSTOMER'S FABRIC

METERS LINEAR NEEDED: 2,00

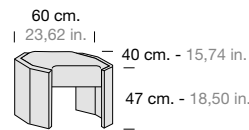

NEW

#### CML2011K

CAT. A	CAT. B	CAT. C	CAT. COM
ECOPELLE/ECONABUK FAUX LEATHER/ECONABUK	LINO/VELLUTO/BOUCLÉ LINEN/VELVET/BOUCLÉ	PELLE LEATHER	TESSUTO CLIENTE C.O.M. CUSTOMER FABRIC
<b>845</b>	<b>868</b>	<b>1.079</b>	<b>799</b>

mc 0,14 – Kg 10

### PANCHETTA DOMINO

TESSUTO CLIENTE

MT. LINEARI NECESSARI: 1,30

### DOMINO BENCH

CUSTOMER'S FABRIC

METERS LINEAR NEEDED: 1,30

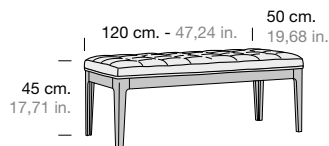

#### DON9081K

CAT. A	CAT. B	CAT. C	CAT. COM
ECOPELLE/ECONABUK FAUX LEATHER/ECONABUK	LINO/VELLUTO/BOUCLÉ LINEN/VELVET/BOUCLÉ	PELLE LEATHER	TESSUTO CLIENTE C.O.M. CUSTOMER FABRIC
<b>1.400</b>	<b>1.450</b>	<b>1.800</b>	<b>1.300</b>

mc 0,33 – Kg 015

CANALETTO

### SGABELLO DOMINO

TESSUTO CLIENTE

MT. LINEARI NECESSARI: 0,80

### DOMINO STOOL

CUSTOMER'S FABRIC

METERS LINEAR NEEDED: 0,80

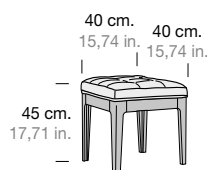

#### DON9181K

CAT. A	CAT. B	CAT. C	CAT. COM
ECOPELLE/ECONABUK FAUX LEATHER/ECONABUK	LINO/VELLUTO/BOUCLÉ LINEN/VELVET/BOUCLÉ	PELLE LEATHER	TESSUTO CLIENTE C.O.M. CUSTOMER FABRIC
<b>950</b>	<b>1.000</b>	<b>1.380</b>	<b>900</b>

mc 0,33 – Kg 015

CANALETTO



**LETTI - SENZA RETE E MATERASSO**  
**BEDS - WITHOUT BED BASE AND MATTRESS**

**LETTO ONIGIRI IMBOTTITO**

FLUTTUANTE CON GIROLETTO E TESTIERA IMBOTTITI CON DECORO IN LEGNO SPINATO

**ONIGIRI PADDED BED**

FLOATING BED WITH PADDED SURROUND AND HEADBOARD WITH HERRINGBONE DETAIL

MISURE RETI DISPONIBILI - DIM. OF AVAILABLE BED BASES

**SMALL**

European size cm. 160 x 200 | in. 63,00 x 78,74  
Queen size cm. 155 x 205 | in. 61,02 x 80,70

**MEDIUM**

European special size cm. 180 x 200 | in. 70,86 x 78,74  
California special size cm. 185 x 215 | in. 72,83 x 84,64  
California size cm. 185 x 205 | in. 70,86 x 80,70

**LARGE**

King size cm. 195 x 205 | in. 76,77 x 80,70  
King special size cm. 195 x 215 | in. 76,77 x 84,64  
King over size cm. 200 x 200 | in. 78,74 x 78,74

**NEW**

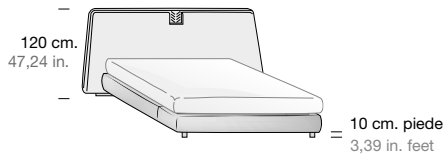

CAT. A	CAT. B	CAT. C	CAT. COM	RETE A DOGHE DI LEGNO WOODEN SLATTER BASE	OPTIONAL
ECOPELLE, ECONABUK FAUX LEATHER, ECONABUK	LINO, VELLUTO, BOUCLÉ LINEN, VELVET, BOUCLÉ	PELLE LEATHER	TESSUTO CLIENTE CUSTOMER'S FABRIC		CONTENITORE FLUTTUANTE CON RETE BASCULANTE FLOATING BOX STORAGE WITH TILTING NET

**SMALL**

**DEN5601K**

cm. L. 190 P. 225 | in. W. 74,80 D. 88,58 - Kg. 85 M³ 0,95  
PER RETE - FOR BED BASE: European size **160 x 200** | in. 63,00 x 78,74

3.450	3.550	4.650	3.000 Mt. L. 7,50	ACS5160K 433	1.990
-------	-------	-------	----------------------	-----------------	-------

**DEN5611K**

cm. L. 185 P. 230 | in. W. 72,83 D. 90,55 - Kg. 85 M³ 0,95  
PER RETE - FOR BED BASE: Queen size **155 x 205** | in. 61,02 x 80,70

3.450	3.550	4.650	3.000 Mt. L. 7,50	ACS5200K 637	-
-------	-------	-------	----------------------	-----------------	---

**MEDIUM**

**DEN5602K**

cm. L. 210 P. 225 | in. W. 82,67 D. 88,58 - Kg. 90 M³ 1,00  
PER RETE - FOR BED BASE: European special size **180 x 200** | in. 70,86 x 78,74

3.600	3.700	4.800	3.150 Mt. L. 8,00	ACS5180K 593	2.100
-------	-------	-------	----------------------	-----------------	-------

**DEN5612K**

cm. L. 215 P. 240 | in. W. 84,64 D. 94,48 - Kg. 95 M³ 1,20  
PER RETE - FOR BED BASE: California special size **185 x 215** | in. 72,83 x 84,64

3.600	3.700	4.800	3.150 Mt. L. 8,00	ACS5220K 696	-
-------	-------	-------	----------------------	-----------------	---

**DEN5622K**

cm. L. 215 P. 230 | in. W. 84,64 D. 90,55 - Kg. 95 M³ 1,20  
PER RETE - FOR BED BASE: California size **185 x 205** | in. 70,86 x 80,70

3.600	3.700	4.800	3.150 Mt. L. 8,00	ACS5210K 653	-
-------	-------	-------	----------------------	-----------------	---

**LARGE**

**DEN5603K**

cm. L. 225 P. 230 | in. W. 88,58 D. 90,55 - Kg. 98 M³ 1,40  
PER RETE - FOR BED BASE: King size **195 x 205** | in. 76,77 x 80,70

3.750	3.880	4.950	3.250 Mt. L. 8,50	ACS5230K 669	-
-------	-------	-------	----------------------	-----------------	---

**DEN5613K**

cm. L. 225 P. 240 | in. W. 88,58 D. 94,48 - Kg. 100 M³ 1,50  
PER RETE - FOR BED BASE: King special size **195 x 215** | in. 76,77 x 84,64

3.750	3.880	4.950	3.250 Mt. L. 8,50	ACS5240K 744	-
-------	-------	-------	----------------------	-----------------	---

**DEN5623K**

cm. L. 230 P. 225 | in. W. 90,55 D. 88,58 - Kg. 110 M³ 1,60  
PER RETE - FOR BED BASE: King over size **200 x 200** | in. 78,74 x 78,74

3.750	3.880	4.950	3.250 Mt. L. 8,50	ACS5250K 776	-
-------	-------	-------	----------------------	-----------------	---

# NOTTE - NIGHT

## LETTI - SENZA RETE E MATERASSO BEDS - WITHOUT BED BASE AND MATTRESS

### LETTO MILÀ

LETTO FLUTTUANTE CON GIROLETTO E TESTATA LEGNO  
POSSIBILITÀ DI PIEDI IN METALLO NERO IN ALTERNATIVA AL PIEDE IN VETRO

### MILÀ BED

FLOATING BED WITH WOODEN SURROUND AND HEADBOARD  
FORWARD INCLINATION. POSSIBILITY OF BLACK METAL FEET AS AN ALTERNATIVE TO THE GLASS FOOT

**NEW**

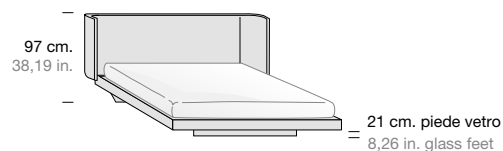

### MISURE RETI DISPONIBILI - DIM. OF AVAILABLE BED BASES

#### SMALL

European size cm. 160 x 200 | in. 63,00 x 78,74  
Queen size cm. 155 x 205 | in. 61,02 x 80,70

#### MEDIUM

European special size cm. 180 x 200 | in. 70,86 x 78,74  
California special size cm. 185 x 215 | in. 72,83 x 84,64  
California size cm. 185 x 205 | in. 70,86 x 80,70

#### LARGE

King size cm. 195 x 205 | in. 76,77 x 80,70  
King special size cm. 195 x 215 | in. 76,77 x 84,64  
King over size cm. 200 x 200 | in. 78,74 x 78,74

PREZZI PRICES	RETE A DOGHE DI LEGNO WOODEN SLATTER BASE	OPTIONAL CONTENITORE IN METALLO CON RETE BASCULANTE, SP. UTILE H.16 METAL BOX STORAGE WITH TILTING NET, US. SPACE H. 6,29 IN.
------------------	--	---

### SMALL

#### CUN5801K

cm. L. 193 P. 205 | in. W. 75,98 D. 80,70 - Kg. 60 M³ 0,20  
PER RETE - FOR BED BASE: European size **160 x 200** | in. 63,00 x 78,74

2.350

ACS5160K

433

ACS5101K

Kg. 30 M³ 0,20  
INTERNO - INTERNAL  
124 x 183 h. 16

1.900

#### CUN5811K

cm. L. 188 P. 210 | in. W. 74,01 D. 82,67 - Kg. 60 M³ 0,20  
PER RETE - FOR BED BASE: Queen size **155 x 205** | in. 61,02 x 80,70

2.350

ACS5200K

637

-

### MEDIUM

#### CUN5802K

cm. L. 213 P. 230 | in. W. 83,85 D. 80,70 - Kg. 65 M³ 0,25  
PER RETE - FOR BED BASE: European special size **180 x 200** | in. 70,86 x 78,74

2.400

ACS5180K

593

ACS5102K

Kg. 40 M³ 0,22  
INTERNO - INTERNAL  
144 x 183 h. 16

2.000

#### CUN5812K

cm. L. 218 P. 240 | in. W. 85,82 D. 94,48 - Kg. 68 M³ 0,28  
PER RETE - FOR BED BASE: California special size **185 x 215** | in. 72,83 x 84,64

2.400

ACS5220K

696

-

#### CUN5822K

cm. L. 218 P. 230 | in. W. 85,82 D. 90,55 - Kg. 68 M³ 0,28  
PER RETE - FOR BED BASE: California size **185 x 205** | in. 70,86 x 80,70

2.400

ACS5210K

653

-

### LARGE

#### CUN5803K

cm. L. 228 P. 230 | in. W. 89,76 D. 90,55 - Kg. 73 M³ 0,30  
PER RETE - FOR BED BASE: King size **195 x 205** | in. 76,77 x 80,70

2.550

ACS5230K

669

-

#### CUN5813K

cm. L. 228 P. 240 | in. W. 89,76 D. 94,48 - Kg. 75 M³ 0,32  
PER RETE - FOR BED BASE: King special size **195 x 215** | in. 76,77 x 84,64

2.550

ACS5240K

744

-

#### CUN5823K

cm. L. 233 P. 225 | in. W. 91,73 D. 88,58 - Kg. 75 M³ 0,32  
PER RETE - FOR BED BASE: King over size **200 x 200** | in. 78,74 x 78,74

2.550

ACS5250K

776

-

### LUCI LED - LED LIGHTS

#### ACS7010C

Accensione a comando su app  
Switching on via app

450

#### ACS7011C

Led per giroletto contenitore - Led for storage box

380

#### ACS7005C

Accensione con pulsante o telecomando  
Switching on with button or remote control

550

#### ACS7005C

Led retro testata - Led headboard back

210

**LETTI - SENZA RETE E MATERASSO**  
**BEDS - WITHOUT BED BASE AND MATTRESS**

**LETTO MILÀ IMBOTTITO**  
LETTO FLUTTUANTE CON GIROLETTO LEGNO E TESTATA IMBOTTITA  
**MILÀ PADDED BED**  
BED WITH WOODEN SURROUND AND PADDED HEADBOARD

MISURE RETI DISPONIBILI - DIM. OF AVAILABLE BED BASES

**SMALL**  
European size cm. 160 x 200 | in. 63,00 x 78,74  
Queen size cm. 155 x 205 | in. 61,02 x 80,70

**MEDIUM**  
European special size cm. 180 x 200 | in. 70,86 x 78,74  
California special size cm. 185 x 215 | in. 72,83 x 84,64  
California size cm. 185 x 205 | in. 70,86 x 80,70

**LARGE**  
King size cm. 195 x 205 | in. 76,77 x 80,70  
King special size cm. 195 x 215 | in. 76,77 x 84,64  
King over size cm. 200 x 200 | in. 78,74 x 78,74

**NEW**



CAT. A	CAT. B	CAT. C	CAT. COM	OPTIONAL
ECOPELLE, ECONABUK FAUX LEATHER, ECONABUK	LINO, VELLUTO, BOUCLÉ LINEN, VELVET, BOUCLÉ	PELLE LEATHER	TESSUTO CLIENTE CUSTOMER'S FABRIC	RETE A DOGHE DI LEGNO WOODEN SLATTER BASE  CONTENITORE IN METALLO CON RETE BASCULANTE, SP. UTILE H.16 METAL BOX STORAGE WITH TILTING NET, US. SPACE H. 6,29 IN.

**SMALL**

<b>CUN5701K</b> cm. L. 193 P. 205   in. W. 75,98 D. 80,70 - Kg. 60 M³ 0,20 PER RETE - FOR BED BASE: European size <b>160 x 200</b>   in. 63,00 x 78,74	2.850	2.950	3.350	2.800 Mt. L. 2,80	ACS5160K 433	ACS5101K Kg. 30 M³ 0,20 INTERNO - INTERNAL 124 x 183 h. 16	1.900
<b>CUN5711K</b> cm. L. 188 P. 210   in. W. 74,01 D. 82,67 - Kg. 60 M³ 0,20 PER RETE - FOR BED BASE: Queen size <b>155 x 205</b>   in. 61,02 x 80,70	2.850	2.950	3.350	2.800 Mt. L. 2,80	ACS5200K 637	-	-

**MEDIUM**

<b>CUN5702K</b> cm. L. 213 P. 205   in. W. 83,85 D. 80,70 - Kg. 65 M³ 0,25 PER RETE - FOR BED BASE: European special size <b>180 x 200</b>   in. 70,86 x 78,74	3.000	3.050	3.450	2.900 Mt. L. 2,80	ACS5180K 593	ACS5102K Kg. 40 M³ 0,22 INTERNO - INTERNAL 144 x 183 h. 16	2.000
<b>CUN5712K</b> cm. L. 218 P. 240   in. W. 85,82 D. 94,48 - Kg. 68 M³ 0,28 PER RETE - FOR BED BASE: California special size <b>185 x 215</b>   in. 72,83 x 84,64	3.000	3.050	3.450	2.900 Mt. L. 2,80	ACS5220K 696	-	-
<b>CUN5722K</b> cm. L. 218 P. 230   in. W. 85,82 D. 90,55 - Kg. 68 M³ 0,28 PER RETE - FOR BED BASE: California size <b>185 x 205</b>   in. 70,86 x 80,70	3.000	3.050	3.450	2.900 Mt. L. 2,80	ACS5210K 653	-	-

**LARGE**

<b>CUN5703K</b> cm. L. 228 P. 230   in. W. 89,76 D. 90,55 - Kg. 73 M³ 0,30 PER RETE - FOR BED BASE: King size <b>195 x 205</b>   in. 76,77 x 80,70	3.100	3.150	3.600	3.050 Mt. L. 2,80	ACS5230K 669	-	-
<b>CUN5713K</b> cm. L. 228 P. 240   in. W. 89,76 D. 94,48 - Kg. 75 M³ 0,32 PER RETE - FOR BED BASE: King special size <b>195 x 215</b>   in. 76,77 x 84,64	3.100	3.150	3.600	3.050 Mt. L. 2,80	ACS5240K 744	-	-
<b>CUN5723K</b> cm. L. 233 P. 225   in. W. 91,73 D. 88,58 - Kg. 75 M³ 0,32 PER RETE - FOR BED BASE: King over size <b>200 x 200</b>   in. 78,74 x 78,74	3.100	3.150	3.600	3.050 Mt. L. 2,80	ACS5250K 776	-	-

**MAGGIORAZIONI - SURCHARGES**

Fascia imbottita su giroletto in legno Upholstered band on wooden bed surround	400	455	555	300 Mt. L. 2,00			
---	-----	-----	-----	--------------------	--	--	--

**LUCI LED - LED LIGHTS**

<b>ACS7010C</b> Accensione a comando su app Switching on via app	450	<b>ACS7011C</b> Led per giroletto contenitore - Led for storage box	380
<b>ACS7005C</b> Accensione con pulsante o telecomando Switching on with button or remote control	550	<b>ACS7005C</b> Led retro testata - Led headboard back	210

# NOTTE - NIGHT

## LETTI - SENZA RETE E MATERASSO BEDS - WITHOUT BED BASE AND MATTRESS

### LETTO BOOK

LETTO FLUTTUANTE CON GIROLETTO E TESTATA LEGNO

N.B. FISSARE LA TESTATA AL MURO. POSSIBILITÀ DI PIEDI IN METALLO NERO IN ALTERNATIVA AL PIEDE IN VETRO

### BOOK BED

FLOATING BED WITH WOODEN HEADBOARD AND SURROUND

N.B. IT IS RECOMMENDED TO FIX THE HEADBOARD TO THE WALL POSSIBILITY OF BLACK METAL FEET AS AN ALTERNATIVE TO THE GLASS FOOT

### MISURE RETI DISPONIBILI - DIM. OF AVAILABLE BED BASES

#### SMALL

European size cm. 160 x 200 | in. 63,00 x 78,74  
Queen size cm. 155 x 205 | in. 61,02 x 80,70

#### MEDIUM

European special size cm. 180 x 200 | in. 70,86 x 78,74  
California special size cm. 185 x 215 | in. 72,83 x 84,64  
California size cm. 185 x 205 | in. 70,86 x 80,70

#### LARGE

King size cm. 195 x 205 | in. 76,77 x 80,70  
King special size cm. 195 x 215 | in. 76,77 x 84,64  
King over size cm. 200 x 200 | in. 78,74 x 78,74

**NEW**

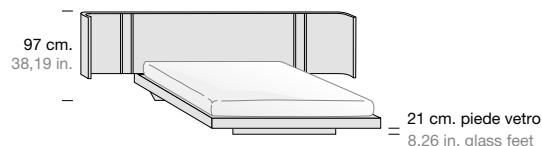

PREZZI PRICES	RETE A DOGHE DI LEGNO WOODEN SLATTER BASE	OPTIONAL CONTENITORE IN METALLO CON RETE BASCULANTE, SP. UTILE H.16 METAL BOX STORAGE WITH TILTING NET, US. SPACE H. 6:29 IN.
------------------	--	---

### SMALL

#### CUN5501K

cm. L. 296 P. 205 | in. W. 116,53 D. 80,70 - Kg. 99 M³ 0,50

PER RETE - FOR BED BASE: European size **160 x 200** | in. 63,00 x 78,74

3.250

ACS5160K

433

ACS5101K

Kg. 30 M³ 0,20  
INTERNO - INTERNAL  
124 x 183 h. 16

1.900

#### CUN5511K

cm. L. 296 P. 210 | in. W. 116,53 D. 82,67 - Kg. 99 M³ 0,50

PER RETE - FOR BED BASE: Queen size **155 x 205** | in. 61,02 x 80,70

3.250

ACS5200K

637

-

### MEDIUM

#### CUN5502K

cm. L. 316 P. 205 | in. W. 124,40 D. 80,70 - Kg. 105 M³ 0,60

PER RETE - FOR BED BASE: European special size **180 x 200** | in. 70,86 x 78,74

3.450

ACS5180K

593

ACS5102K

Kg. 40 M³ 0,22  
INTERNO - INTERNAL  
144 x 183 h. 16

2.000

#### CUN5512K

cm. L. 316 P. 240 | in. W. 124,40 D. 94,48 - Kg. 110 M³ 0,65

PER RETE - FOR BED BASE: California special size **185 x 215** | in. 72,83 x 84,64

3.450

ACS5220K

696

-

#### CUN5522K

cm. L. 316 P. 230 | in. W. 124,40 D. 90,55 - Kg. 108 M³ 0,60

PER RETE - FOR BED BASE: California size **185 x 205** | in. 70,86 x 80,70

3.450

ACS5210K

653

-

### LARGE

#### CUN5503K

cm. L. 316 P. 230 | in. W. 124,40 D. 90,55 - Kg. 112 M³ 0,67

PER RETE - FOR BED BASE: King size **195 x 205** | in. 76,77 x 80,70

3.650

ACS5230K

669

-

#### CUN5513K

cm. L. 316 P. 240 | in. W. 124,40 D. 94,48 - Kg. 115 M³ 0,70

PER RETE - FOR BED BASE: King special size **195 x 215** | in. 76,77 x 84,64

3.650

ACS5240K

744

-

#### CUN5523K

cm. L. 336 P. 225 | in. W. 132,28 D. 88,58 - Kg. 120 M³ 0,75

PER RETE - FOR BED BASE: King over size **200 x 200** | in. 78,74 x 78,74

3.650

ACS5250K

776

-

### LUCI LED - LED LIGHTS

#### ACS7010C

Accensione a comando su app

Switching on via app

450

#### ACS7004C

Led per gamba in vetro - Led for glass leg

210

#### ACS7005C

Accensione con pulsante o telecomando

Switching on with button or remote control

550

#### ACS7011C

Led per giroletto contenitore - Led for storage box

380

#### ACS7005C

Led retro testata - Led headboard back

380

### ACCESSORI LETTO - BED ACCESSORIES

#### ACS7107C (sx/lh) - ACS7117C (dx/rh)

Comodino sospeso 1 cassetto - Hanging night stand 1 drawer

Kg. 8 M³ 0,02

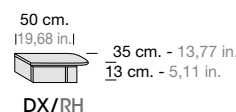
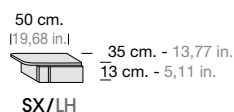

850

#### ACS7207C

Top in ceramica - Ceramic top

Kg. 4 M³ 0,001

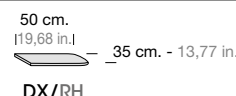
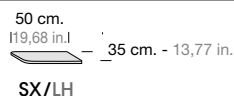

250

#### ACS7006C

Ripiano in vetro - Glas shelf

Kg. 2 M³ 0,001

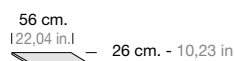

260

**LETTI - SENZA RETE E MATERASSO**  
**BEDS - WITHOUT BED BASE AND MATTRESS**

**LETTO BOOK IMBOTTITO**

LETTO FLUTTUANTE CON GIROLETTO LEGNO E TESTATA IMBOTTITA  
N.B. FISSARE LA TESTATA AL MURO. POSSIBILITÀ DI PIEDI IN METALLO NERO IN ALTERNATIVA AL PIEDE IN VETRO

**BOOK PADDED BED**

BED WITH WOODEN SURROUND AND PADDED HEADBOARD  
N.B. IT IS RECOMMENDED TO FIX THE HEADBOARD TO THE WALL POSSIBILITY OF BLACK METAL FEET AS AN ALTERNATIVE TO THE GLASS FOOT

MISURE RETI DISPONIBILI - DIM. OF AVAILABLE BED BASES

**SMALL**

European size cm. 160 x 200 | in. 63,00 x 78,74  
Queen size cm. 155 x 205 | in. 61,02 x 80,70

**MEDIUM**

European special size cm. 180 x 200 | in. 70,86 x 78,74  
California special size cm. 185 x 215 | in. 72,83 x 84,64  
California size cm. 185 x 205 | in. 70,86 x 80,70

**LARGE**

King size cm. 195 x 205 | in. 76,77 x 80,70  
King special size cm. 195 x 215 | in. 76,77 x 84,64  
King over size cm. 200 x 200 | in. 78,74 x 78,74

**NEW**



CAT. A	CAT. B	CAT. C	CAT. COM	OPTIONAL
ECOPELLE, ECONABUK FAUX LEATHER, ECONABUK	LINO, VELLUTO, BOUCLÉ LINEN, VELVET, BOUCLÉ	PELLE LEATHER	TESSUTO CLIENTE CUSTOMER'S FABRIC	RETE A DOGHE DI LEGNO WOODEN SLATTER BASE
				CONTENITORE IN METALLO CON RETE BASCULANTE, SP. UTILE H.16 METAL BOX STORAGE WITH TILTING NET, US. SPACE H. 6,29 IN.

**SMALL**

<b>CUN5601K</b> cm. L. 296 P. 205   in. W. 116,53 D. 80,70 - Kg. 99 M³ 0,50 PER RETE - FOR BED BASE: European size <b>160 x 200</b>   in. 63,00 x 78,74	<b>3.750</b>	<b>3.900</b>	<b>4.200</b>	<b>3.600</b> Mt. L. 2,80	<b>ACS5160K</b> <b>433</b>	<b>ACS5101K</b> Kg. 30 M³ 0,20 INTERNO - INTERNAL 124 x 183 h. 16	<b>1.900</b>	-
---	--------------	--------------	--------------	-----------------------------	-------------------------------	--	--------------	---

<b>CUN5611K</b> cm. L. 296 P. 210   in. W. 116,53 D. 82,67 - Kg. 99 M³ 0,50 PER RETE - FOR BED BASE: Queen size <b>155 x 205</b>   in. 61,02 x 80,70	<b>3.750</b>	<b>3.900</b>	<b>4.200</b>	<b>3.600</b> Mt. L. 2,80	<b>ACS5200K</b> <b>637</b>	-	-	-
--	--------------	--------------	--------------	-----------------------------	-------------------------------	---	---	---

**MEDIUM**

<b>CUN5602K</b> cm. L. 316 P. 205   in. W. 124,40 D. 80,70 - Kg. 105 M³ 0,60 PER RETE - FOR BED BASE: European special size <b>180 x 200</b>   in. 70,86 x 78,74	<b>3.900</b>	<b>4.100</b>	<b>4.400</b>	<b>3.800</b> Mt. L. 2,80	<b>ACS5180K</b> <b>593</b>	<b>ACS5102K</b> Kg. 40 M³ 0,22 INTERNO - INTERNAL 144 x 183 h. 16	<b>2.000</b>	-
--	--------------	--------------	--------------	-----------------------------	-------------------------------	--	--------------	---

<b>CUN5612K</b> cm. L. 316 P. 240   in. W. 124,40 D. 94,48 - Kg. 110 M³ 0,65 PER RETE - FOR BED BASE: California special size <b>185 x 215</b>   in. 72,83 x 84,64	<b>3.900</b>	<b>4.100</b>	<b>4.400</b>	<b>3.800</b> Mt. L. 2,80	<b>ACS5220K</b> <b>696</b>	-	-	-
--	--------------	--------------	--------------	-----------------------------	-------------------------------	---	---	---

<b>CUN5622K</b> cm. L. 316 P. 230   in. W. 124,40 D. 90,55 - Kg. 108 M³ 0,60 PER RETE - FOR BED BASE: California size <b>185 x 205</b>   in. 70,86 x 80,70	<b>3.900</b>	<b>4.100</b>	<b>4.400</b>	<b>3.800</b> Mt. L. 2,80	<b>ACS5210K</b> <b>653</b>	-	-	-
--	--------------	--------------	--------------	-----------------------------	-------------------------------	---	---	---

**LARGE**

<b>CUN5603K</b> cm. L. 316 P. 230   in. W. 124,40 D. 90,55 - Kg. 112 M³ 0,67 PER RETE - FOR BED BASE: King size <b>195 x 205</b>   in. 76,77 x 80,70	<b>4.100</b>	<b>4.280</b>	<b>4.600</b>	<b>4.000</b> Mt. L. 2,80	<b>ACS5230K</b> <b>669</b>	-	-	-
--	--------------	--------------	--------------	-----------------------------	-------------------------------	---	---	---

<b>CUN5613K</b> cm. L. 316 P. 240   in. W. 124,40 D. 94,48 - Kg. 115 M³ 0,70 PER RETE - FOR BED BASE: King special size <b>195 x 215</b>   in. 76,77 x 84,64	<b>4.100</b>	<b>4.280</b>	<b>4.600</b>	<b>4.000</b> Mt. L. 2,80	<b>ACS5240K</b> <b>744</b>	-	-	-
--	--------------	--------------	--------------	-----------------------------	-------------------------------	---	---	---

<b>CUN5623K</b> cm. L. 336 P. 225   in. W. 132,28 D. 88,58 - Kg. 120 M³ 0,75 PER RETE - FOR BED BASE: King over size <b>200 x 200</b>   in. 78,74 x 78,74	<b>4.100</b>	<b>4.280</b>	<b>4.600</b>	<b>4.000</b> Mt. L. 2,80	<b>ACS5250K</b> <b>776</b>	-	-	-
---	--------------	--------------	--------------	-----------------------------	-------------------------------	---	---	---

**LUCI LED - LED LIGHTS**

<b>ACS7010C</b> Accensione a comando su app Switching on via app	<b>450</b>	<b>ACS7004C</b> Led per gamba in vetro - Led for glass leg	<b>210</b>
--	------------	---	------------

<b>ACS7005C</b> Accensione con pulsante o telecomando Switching on with button or remote control	<b>550</b>	<b>ACS7011C</b> Led per giroletto contenitore - Led for storage box	<b>380</b>
--	------------	--	------------

<b>ACS7005C</b> Led retro testata - Led headboard back	<b>380</b>		
---	------------	--	--

**ACCESSORI LETTO - BED ACCESSORIES**

<b>ACS7107C (sx/lh) - ACS7117C (dx/rh)</b> Comodino sospeso 1 cassetto - Hanging night stand 1 drawer Kg. 8 M³ 0,02	50 cm. (19,68 in.) 35 cm. - 13,77 in. 13 cm. - 5,11 in. SX/LH	50 cm. (19,68 in.) 35 cm. - 13,77 in. 13 cm. - 5,11 in. DX/RH	<b>850</b>
---	--	--	------------

<b>ACS7207C</b> Top in ceramica - Ceramic top Kg. 4 M³ 0,001	50 cm. (19,68 in.) 35 cm. - 13,77 in. SX/LH	50 cm. (19,68 in.) 35 cm. - 13,77 in. DX/RH	<b>250</b>
--	---	---	------------

<b>ACS7006C</b> Ripiano in vetro - Glas shelf Kg. 2 M³ 0,001	56 cm. (22,04 in.) 26 cm. - 10,23 in.		<b>260</b>
--	--	--	------------

# NOTTE - NIGHT

## LETTI - SENZA RETE E MATERASSO BEDS - WITHOUT BED BASE AND MATTRESS

### LETTO YORK IMBOTTITO

LETTO FLUTTUANTE CON GIROLETTO LEGNO E TESTATA IMBOTTITA  
N.B. FISSARE LA TESTATA AL MURO. POSSIBILITÀ DI PIEDI IN METALLO NERO IN ALTERNATIVA AL PIEDE IN VETRO

### YORK PADDED BED

BED WITH WOODEN SURROUND AND PADDED HEADBOARD

N.B. IT IS RECOMMENDED TO FIX THE HEADBOARD TO THE WALL POSSIBILITY OF BLACK METAL FEET AS AN ALTERNATIVE TO THE GLASS FOOT

### MISURE RETI DISPONIBILI - DIM. OF AVAILABLE BED BASES

#### SMALL

European size cm. 160 x 200 | in. 63,00 x 78,74  
Queen size cm. 155 x 205 | in. 61,02 x 80,70

#### MEDIUM

European special size cm. 180 x 200 | in. 70,86 x 78,74  
California special size cm. 185 x 215 | in. 72,83 x 84,64  
California size cm. 185 x 205 | in. 70,86 x 80,70

#### LARGE

King size cm. 195 x 205 | in. 76,77 x 80,70  
King special size cm. 195 x 215 | in. 76,77 x 84,64  
King over size cm. 200 x 200 | in. 78,74 x 78,74

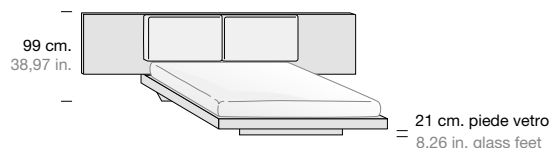

CAT. A	CAT. B	CAT. C	CAT. COM	RETE A DOGHE DI LEGNO WOODEN SLATTER BASE	OPTIONAL
ECOPELLE, ECONABUK FAUX LEATHER, ECONABUK	LINO, VELLUTO, BOUCLÉ LINEN, VELVET, BOUCLÉ	PELLE LEATHER	TESSUTO CLIENTE CUSTOMER'S FABRIC		CONTENITORE IN METALLO CON RETE BASCULANTE, SP. UTILE H.16 METAL BOX STORAGE WITH TILTING NET, US. SPACE H. 6,29 IN.

### SMALL

#### DEN5301K

cm. L. 290 P. 210 | in. W. 114,17 D. 82,67 - Kg. 99 M³ 0,50  
PER RETE - FOR BED BASE: European size **160 x 200** | in. 63,00 x 78,74

2.950	3.100	3.600	2.900 Mt. L. 2,80	ACS5160K 433	ACS5101K Kg. 30 M³ 0,20 INTERNO - INTERNAL 124 x 183 h. 16	1.900
-------	-------	-------	----------------------	-----------------	---	-------

#### DEN5311K

cm. L. 290 P. 215 | in. W. 114,17 D. 84,64 - Kg. 99 M³ 0,50  
PER RETE - FOR BED BASE: Queen size **155 x 205** | in. 61,02 x 80,70

2.950	3.100	3.600	2.900 Mt. L. 2,80	ACS5200K 637	-	-
-------	-------	-------	----------------------	-----------------	---	---

### MEDIUM

#### DEN5302K

cm. L. 310 P. 210 | in. W. 122,04 D. 82,67 - Kg. 105 M³ 0,60  
PER RETE - FOR BED BASE: European special size **180 x 200** | in. 70,86 x 78,74

3.250	3.410	3.960	3.000 Mt. L. 2,80	ACS5180K 593	ACS5102K Kg. 40 M³ 0,22 INTERNO - INTERNAL 144 x 183 h. 16	2.000
-------	-------	-------	----------------------	-----------------	---	-------

#### DEN5312K

cm. L. 310 P. 225 | in. W. 122,04 D. 88,58 - Kg. 110 M³ 0,65  
PER RETE - FOR BED BASE: California special size **185 x 215** | in. 72,83 x 84,64

3.250	3.410	3.960	3.000 Mt. L. 2,80	ACS5220K 696	-	-
-------	-------	-------	----------------------	-----------------	---	---

#### DEN5322K

cm. L. 310 P. 215 | in. W. 122,04 D. 84,64 - Kg. 108 M³ 0,60  
PER RETE - FOR BED BASE: California size **185 x 205** | in. 70,86 x 80,70

3.250	3.410	3.960	3.000 Mt. L. 2,80	ACS5210K 653	-	-
-------	-------	-------	----------------------	-----------------	---	---

### LARGE

#### DEN5303K

cm. L. 325 P. 215 | in. W. 127,95 D. 84,64 - Kg. 112 M³ 0,67  
PER RETE - FOR BED BASE: King size **195 x 205** | in. 76,77 x 80,70

3.450	3.610	4.160	3.100 Mt. L. 2,80	ACS5230K 669	-	-
-------	-------	-------	----------------------	-----------------	---	---

#### DEN5313K

cm. L. 325 P. 225 | in. W. 127,95 D. 88,58 - Kg. 115 M³ 0,70  
PER RETE - FOR BED BASE: King special size **195 x 215** | in. 76,77 x 84,64

3.450	3.610	4.160	3.100 Mt. L. 2,80	ACS5240K 744	-	-
-------	-------	-------	----------------------	-----------------	---	---

#### DEN5323K

cm. L. 325 P. 210 | in. W. 127,95 D. 82,67 - Kg. 120 M³ 0,75  
PER RETE - FOR BED BASE: King over size **200 x 200** | in. 78,74 x 78,74

3.450	3.610	4.160	3.100 Mt. L. 2,80	ACS5250K 776	-	-
-------	-------	-------	----------------------	-----------------	---	---

### ACCESSORI LETTO - BED ACCESSORIES

#### ACS7008C (sx/lh) - ACS7018C (dx/rh)

porta oggetti con ripiani in vetro - Object holder with glass shelf  
Kg. 6 M³ 0,10

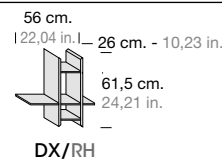
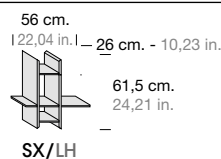

500
-----

#### ACS7007C (sx/lh) - ACS7017C (dx/rh)

Comodino sospeso 1 cassetto - Hanging night stand 1 drawer  
Kg. 8 M³ 0,02

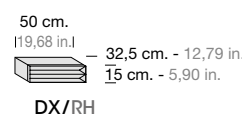
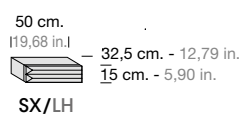

900
-----

#### OPTIONAL Top in ceramica - Ceramic top

250
-----

#### ACS7006C

Ripiano in vetro - Glas shelf  
Kg. 2 M³ 0,001

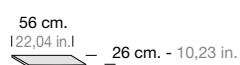

250
-----

### LUCI LED - LED LIGHTS

#### ACS7010C

Accensione a comando su app - Switching on via app

450
-----

#### ACS7004C

Led per gamba in vetro - Led for glass leg

210
-----

#### ACS7005C

Accensione con pulsante o telecomando - Switching on with button or remote control

550
-----

#### ACS7011C

Led per giroletto contenitore - Led for storage box

380
-----

#### ACS7005C

Led retro testata - Led headboard back

380
-----

**LETTI - SENZA RETE E MATERASSO**  
**BEDS - WITHOUT BED BASE AND MATTRESS**

**LETTO YORK SOFT IMBOTTITO**

LETTO FLUTTUANTE CON GIROLETTO LEGNO E TESTATA IMBOTTITA

N.B. FISSARE LA TESTATA AL MURO. POSSIBILITÀ DI PIEDI IN METALLO NERO IN ALTERNATIVA AL PIEDE IN VETRO

**YORK SOFT PADDED BED**

BED WITH WOODEN SURROUND AND PADDED HEADBOARD

N.B. IT IS RECOMMENDED TO FIX THE HEADBOARD TO THE WALL POSSIBILITY OF BLACK METAL FEET AS AN ALTERNATIVE TO THE GLASS FOOT

MISURE RETI DISPONIBILI - DIM. OF AVAILABLE BED BASES

**SMALL**

European size cm. 160 x 200 | in. 63,00 x 78,74  
Queen size cm. 155 x 205 | in. 61,02 x 80,70

**MEDIUM**

European special size cm. 180 x 200 | in. 70,86 x 78,74  
California special size cm. 185 x 215 | in. 72,83 x 84,64  
California size cm. 185 x 205 | in. 70,86 x 80,70

**LARGE**

King size cm. 195 x 205 | in. 76,77 x 80,70  
King special size cm. 195 x 215 | in. 76,77 x 84,64  
King over size cm. 200 x 200 | in. 78,74 x 78,74

**NEW**

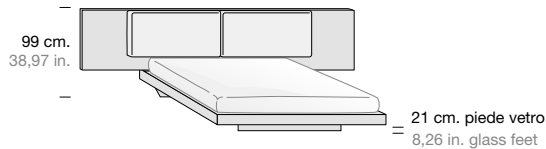

CAT. A	CAT. B	CAT. C	CAT. COM	OPTIONAL
ECOPELLE, ECONABUK FAUX LEATHER, ECONABUK	LINO, VELLUTO, BOUCLÉ LINEN, VELVET, BOUCLÉ	PELLE LEATHER	TESSUTO CLIENTE CUSTOMER'S FABRIC	RETE A DOGHE DI LEGNO WOODEN SLATTER BASE CONTENITORE IN METALLO CON RETE BASCULANTE METAL BOX STORAGE WITH TILTING NET

**SMALL**

**DEN5401K**

cm. L. 290 P. 210 | in. W. 114,17 D. 82,67 - Kg. 99 M³ 0,50  
PER RETE - FOR BED BASE: European size **160 x 200** | in. 63,00 x 78,74

3.200	3.250	3.750	3.100 Mt. L. 3,00	ACS5160K 433	ACS5101K Kg. 30 M³ 0,20 INTERNO - INTERNAL 124 x 183 h. 16 1.900
-------	-------	-------	----------------------	-----------------	--

**DEN5411K**

cm. L. 290 P. 215 | in. W. 114,17 D. 84,64 - Kg. 99 M³ 0,50  
PER RETE - FOR BED BASE: Queen size **155 x 205** | in. 61,02 x 80,70

3.200	3.250	3.750	3.100 Mt. L. 3,00	ACS5200K 637	-
-------	-------	-------	----------------------	-----------------	---

**MEDIUM**

**DEN5402K**

cm. L. 310 P. 210 | in. W. 122,04 D. 82,67 - Kg. 105 M³ 0,60  
PER RETE - FOR BED BASE: European special size **180 x 200** | in. 70,86 x 78,74

3.520	3.575	4.125	3.300 Mt. L. 3,00	ACS5180K 593	ACS5102K Kg. 40 M³ 0,22 INTERNO - INTERNAL 144 x 183 h. 16 2.000
-------	-------	-------	----------------------	-----------------	--

**DEN5412K**

cm. L. 310 P. 225 | in. W. 122,04 D. 88,58 - Kg. 110 M³ 0,65  
PER RETE - FOR BED BASE: California special size **185 x 215** | in. 72,83 x 84,64

3.520	3.575	4.125	3.300 Mt. L. 3,00	ACS5220K 696	-
-------	-------	-------	----------------------	-----------------	---

**DEN5422K**

cm. L. 310 P. 215 | in. W. 122,04 D. 84,64 - Kg. 108 M³ 0,60  
PER RETE - FOR BED BASE: California size **185 x 205** | in. 70,86 x 80,70

3.520	3.575	4.125	3.300 Mt. L. 3,00	ACS5210K 653	-
-------	-------	-------	----------------------	-----------------	---

**LARGE**

**DEN5403K**

cm. L. 325 P. 215 | in. W. 127,95 D. 84,64 - Kg. 112 M³ 0,67  
PER RETE - FOR BED BASE: King size **195 x 205** | in. 76,77 x 80,70

3.620	3.675	4.325	3.500 Mt. L. 3,00	ACS5230K 669	-
-------	-------	-------	----------------------	-----------------	---

**DEN5413K**

cm. L. 325 P. 225 | in. W. 127,95 D. 88,58 - Kg. 115 M³ 0,70  
PER RETE - FOR BED BASE: King special size **195 x 215** | in. 76,77 x 84,64

3.620	3.675	4.325	3.500 Mt. L. 3,00	ACS5240K 744	-
-------	-------	-------	----------------------	-----------------	---

**DEN5423K**

cm. L. 325 P. 210 | in. W. 127,95 D. 82,67 - Kg. 120 M³ 0,75  
PER RETE - FOR BED BASE: King over size **200 x 200** | in. 78,74 x 78,74

3.620	3.675	4.325	3.500 Mt. L. 3,00	ACS5250K 776	-
-------	-------	-------	----------------------	-----------------	---

**ACCESSORI LETTO - BED ACCESSORIES**

**ACS7007C (sx/lh) - ACS7017C (dx/rh)**

Comodino sospeso 1 cassetto - Hanging night stand 1 drawer  
Kg. 8 M³ 0,02



900

OPTIONAL Top in ceramica - Ceramic top

250

**ACS7006C**

Ripiano in vetro - Glas shelf  
Kg. 2 M³ 0,001

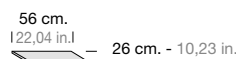

250

**LUCI LED - LED LIGHTS**

**ACS7010C**

Accensione a comando su app  
Switching on via app

450

**ACS7004C**

Led per gamba in vetro - Led for glass leg

210

**ACS7005C**

Accensione con pulsante o telecomando  
Switching on with button or remote control

550

**ACS7011C**

Led per giroletto contenitore - Led for storage box

380

**ACS7005C**

Led retro testata - Led headboard back

380

# NOTTE - NIGHT

## LETTI - SENZA RETE E MATERASSO BEDS - WITHOUT BED BASE AND MATTRESS

### LETTO ALBA IMBOTTITO

LETTO CON GIROLETTO LEGNO E TESTATA IMBOTTITA

### ALBA PADDED BED

BED WITH WOODEN SURROUND AND PADDED HEADBOARD

MISURE RETI DISPONIBILI - DIM. OF AVAILABLE BED BASES

#### SMALL

European size cm. 160 x 200 | in. 63,00 x 78,74  
Queen size cm. 155 x 205 | in. 61,02 x 80,70

#### MEDIUM

European special size cm. 180 x 200 | in. 70,86 x 78,74  
California special size cm. 185 x 215 | in. 72,83 x 84,64  
California size cm. 185 x 205 | in. 70,86 x 80,70

#### LARGE

King size cm. 195 x 205 | in. 76,77 x 80,70  
King special size cm. 195 x 215 | in. 76,77 x 84,64  
King over size cm. 200 x 200 | in. 78,74 x 78,74



CAT. A	CAT. B	CAT. C	CAT. COM	RETE A DOGHE DI LEGNO WOODEN SLATTER BASE	OPTIONAL
ECOPELLE, ECONABUK FAUX LEATHER, ECONABUK	LINO, VELLUTO, BOUCLÉ LINEN, VELVET, BOUCLÉ	PELLE LEATHER	TESSUTO CLIENTE CUSTOMER'S FABRIC		

### SMALL

#### SHN5301K

cm. L. 170 P. 215 | in. W. 66,92 D. 84,64 - Kg. 75 M³ 0,90  
PER RETE - FOR BED BASE: European size **cm. 160 x 200** | in. 63,00 x 78,74

3.300

3.450

4.450

3.100  
Mt. L. 4,00

ACS5160K  
433

-

#### SHN5311K

cm. L. 165 P. 220 | in. W. 64,96 D. 86,61 - Kg. 80 M³ 0,30  
PER RETE - FOR BED BASE: Queen size **cm. 155 x 205** | in. 61,02 x 80,70

3.300

3.450

4.450

3.100  
Mt. L. 4,00

ACS5200K  
637

-

### MEDIUM

#### SHN5302K

cm. L. 190 P. 215 | in. W. 74,80 D. 84,64 - Kg. 80 M³ 0,95  
PER RETE - FOR BED BASE: European special size **cm. 180 x 200** | in. 70,86 x 78,74

3.550

3.650

4.850

3.300  
Mt. L. 4,20

ACS5180K  
593

-

#### SHN5312K

cm. L. 195 P. 230 | in. W. 76,77 D. 90,55 - Kg. 90 M³ 0,38  
PER RETE - FOR BED BASE: California special size **cm. 185 x 215** | in. 72,83 x 84,64

3.550

3.650

4.850

3.300  
Mt. L. 4,20

ACS5220K  
696

-

#### SHN5322K

cm. L. 195 P. 220 | in. W. 76,77 D. 86,61 - Kg. 88 M³ 0,36  
PER RETE - FOR BED BASE: California size **cm. 185 x 205** | in. 70,86 x 80,70

3.550

3.650

4.850

3.300  
Mt. L. 4,20

ACS5210K  
653

-

### LARGE

#### SHN5303K

cm. L. 205 P. 220 | in. W. 80,70 D. 86,61 - Kg. 93 M³ 0,40  
PER RETE - FOR BED BASE: King size **cm. 195 x 205** | in. 76,77 x 80,70

3.750

3.850

5.100

3.500  
Mt. L. 4,30

ACS5230K  
669

-

#### SHN5313K

cm. L. 205 P. 230 | in. W. 80,70 D. 90,55 - Kg. 96 M³ 0,42  
PER RETE - FOR BED BASE: King special size **cm. 195 x 215** | in. 76,77 x 84,64

3.750

3.850

5.100

3.500  
Mt. L. 4,30

ACS5240K  
744

-

#### SHN5323K

cm. L. 210 P. 215 | in. W. 82,67 D. 84,64 - Kg. 100 M³ 0,45  
PER RETE - FOR BED BASE: King over size **cm. 200 x 200** | in. 78,74 x 78,74

3.750

3.850

5.100

3.500  
Mt. L. 4,30

ACS5250K  
776

-

### MAGGIORAZIONI - SURCHARGES

Fascia imbottita su giroletto in legno  
Upholstered band on wooden bed surround

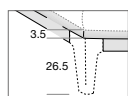

400

455

555

300  
Mt. L. 2,00



**LETTI - SENZA RETE E MATERASSO**  
**BEDS - WITHOUT BED BASE AND MATTRESS**

**LETTO ALBA IMBOTTITO**

LETTO FLUTTUANTE CON GIROLETTO E TESTATA IMBOTTITI

**ALBA PADDED BED**

FLOATING BED WITH PADDED SURROUND AND HEADBOARD

MISURE RETI DISPONIBILI - DIM. OF AVAILABLE BED BASES

**SMALL**

European size cm. 160 x 200 | in. 63,00 x 78,74  
Queen size cm. 155 x 205 | in. 61,02 x 80,70

**MEDIUM**

European special size cm. 180 x 200 | in. 70,86 x 78,74  
California special size cm. 185 x 215 | in. 72,83 x 84,64  
California size cm. 185 x 205 | in. 70,86 x 80,70

**LARGE**

King size cm. 195 x 205 | in. 76,77 x 80,70  
King special size cm. 195 x 215 | in. 76,77 x 84,64  
King over size cm. 200 x 200 | in. 78,74 x 78,74

**NEW**

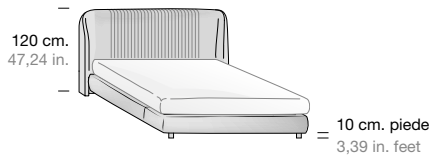

CAT. A	CAT. B	CAT. C	CAT. COM		OPTIONAL
ECOPELLE, ECONABUK FAUX LEATHER, ECONABUK	LINO, VELLUTO, BOUCLÉ LINEN, VELVET, BOUCLÉ	PELLE LEATHER	TESSUTO CLIENTE CUSTOMER'S FABRIC	RETE A DOGHE DI LEGNO WOODEN SLATTER BASE	CONTENITORE A TERRA CON RETE BASCULANTE BOX STORAGE WITH TILTING NET

**SMALL**

**DEN5131K**

cm. L. 170 P. 216 | in. W. 66,92 D. 85,03 - Kg. 85 M³ 0,95  
PER RETE - FOR BED BASE: European size **160 x 200** | in. 63,00 x 78,74

3.750	3.850	4.950	3.350 Mt. L. 6,50	ACS5160K 433	680
-------	-------	-------	----------------------	-----------------	-----

**DEN5141K**

cm. L. 165 P. 221 | in. W. 64,96 D. 87,00 - Kg. 85 M³ 0,95  
PER RETE - FOR BED BASE: Queen size **155 x 205** | in. 61,02 x 80,70

3.750	3.850	4.950	3.350 Mt. L. 6,50	ACS5200K 637	-
-------	-------	-------	----------------------	-----------------	---

**MEDIUM**

**DEN5132K**

cm. L. 190 P. 216 | in. W. 74,80 D. 85,03 - Kg. 90 M³ 1,00  
PER RETE - FOR BED BASE: European special size **180 x 200** | in. 70,86 x 78,74

3.950	4.150	5.550	3.600 Mt. L. 6,70	ACS5180K 593	750
-------	-------	-------	----------------------	-----------------	-----

**DEN5142K**

cm. L. 195 P. 231 | in. W. 76,77 D. 90,94 - Kg. 95 M³ 1,20  
PER RETE - FOR BED BASE: California special size **185 x 215** | in. 72,83 x 84,64

3.950	4.150	5.550	3.600 Mt. L. 6,70	ACS5220K 696	-
-------	-------	-------	----------------------	-----------------	---

**DEN5152K**

cm. L. 195 P. 221 | in. W. 76,77 D. 87,00 - Kg. 95 M³ 1,20  
PER RETE - FOR BED BASE: California size **185 x 205** | in. 70,86 x 80,70

3.950	4.150	5.550	3.600 Mt. L. 6,70	ACS5210K 653	-
-------	-------	-------	----------------------	-----------------	---

**LARGE**

**DEN5133K**

cm. L. 205 P. 221 | in. W. 80,70 D. 87,00 - Kg. 98 M³ 1,40  
PER RETE - FOR BED BASE: King size **195 x 205** | in. 76,77 x 80,70

4.250	4.430	5.950	3.850 Mt. L. 6,80	ACS5230K 669	-
-------	-------	-------	----------------------	-----------------	---

**DEN5143K**

cm. L. 205 P. 231 | in. W. 80,70 D. 90,94 - Kg. 100 M³ 1,50  
PER RETE - FOR BED BASE: King special size **195 x 215** | in. 76,77 x 84,64

4.250	4.430	5.950	3.850 Mt. L. 6,80	ACS5240K 744	-
-------	-------	-------	----------------------	-----------------	---

**DEN5153K**

cm. L. 210 P. 216 | in. W. 82,67 D. 85,03 - Kg. 110 M³ 1,60  
PER RETE - FOR BED BASE: King over size **200 x 200** | in. 78,74 x 78,74

4.250	4.430	5.950	3.850 Mt. L. 6,80	ACS5250K 776	-
-------	-------	-------	----------------------	-----------------	---

# NOTTE - NIGHT

## LETTI - SENZA RETE E MATERASSO BEDS - WITHOUT BED BASE AND MATTRESS

### LETTO ALBA IMBOTTITO

LETTO CON GIROLETTO E TESTATA IMBOTTITI

#### ALBA PADDED BED

BED WITH PADDED SURROUND AND HEADBOARD

MISURE RETI DISPONIBILI - DIM. OF AVAILABLE BED BASES

#### SMALL

European size cm. 160 x 200 | in. 63,00 x 78,74  
Queen size cm. 155 x 205 | in. 61,02 x 80,70

#### MEDIUM

European special size cm. 180 x 200 | in. 70,86 x 78,74  
California special size cm. 185 x 215 | in. 72,83 x 84,64  
California size cm. 185 x 205 | in. 70,86 x 80,70

#### LARGE

King size cm. 195 x 205 | in. 76,77 x 80,70  
King special size cm. 195 x 215 | in. 76,77 x 84,64  
King over size cm. 200 x 200 | in. 78,74 x 78,74

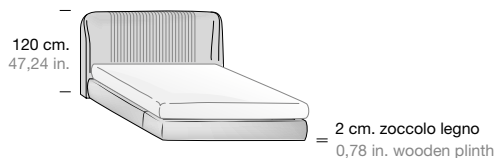

CAT. A	CAT. B	CAT. C	CAT. COM	RETE A DOGHE DI LEGNO WOODEN SLATTER BASE	OPTIONAL CONTENITORE A TERRA CON RETE BASCULANTE BOX STORAGE WITH TILTING NET
ECOPELLE, ECONABUK FAUX LEATHER, ECONABUK	LINO, VELLUTO, BOUCLÉ LINEN, VELVET, BOUCLÉ	PELLE LEATHER	TESSUTO CLIENTE CUSTOMER'S FABRIC		

### SMALL

#### SHN5701K

cm. L. 170 P. 216 | in. W. 66,92 D. 85,03 - Kg. 95 M³ 1,15  
PER RETE - FOR BED BASE: European size **160 x 200** | in. 63,00 x 78,74

3.950	4.050	5.050	3.550 Mt. L. 6,50	ACS5160K 433	Kg. 66 M³ 0,40 INTERNO - INTERNAL 162 x 202 h. 16	680
-------	-------	-------	----------------------	-----------------	---	-----

#### SHN5711K

cm. L. 165 P. 221 | in. W. 64,96 D. 87,00 - Kg. 80 M³ 0,30  
PER RETE - FOR BED BASE: Queen size **155 x 205** | in. 61,02 x 80,70

3.950	4.050	5.050	3.550 Mt. L. 6,50	ACS5200K 637	-	
-------	-------	-------	----------------------	-----------------	---	--

### MEDIUM

#### SHN5702K

cm. L. 190 P. 228 | in. W. 74,80 D. 89,76 - Kg. 105 M³ 1,40  
PER RETE - FOR BED BASE: European special size **180 x 200** | in. 70,86 x 78,74

4.150	4.350	5.750	3.800 Mt. L. 6,70	ACS5180K 593	Kg. 66 M³ 0,40 INTERNO - INTERNAL 182 x 202 h. 16	750
-------	-------	-------	----------------------	-----------------	---	-----

#### SHN5712K

cm. L. 195 P. 231 | in. W. 76,77 D. 90,94 - Kg. 90 M³ 0,38  
PER RETE - FOR BED BASE: California special size **185 x 215** | in. 72,83 x 84,64

4.150	4.350	5.750	3.800 Mt. L. 6,70	ACS5220K 696	-	
-------	-------	-------	----------------------	-----------------	---	--

#### SHN5722K

cm. L. 195 P. 221 | in. W. 76,77 D. 87,00 - Kg. 88 M³ 0,36  
PER RETE - FOR BED BASE: California size **185 x 205** | in. 70,86 x 80,70

4.150	4.350	5.750	3.800 Mt. L. 6,70	ACS5210K 653	-	
-------	-------	-------	----------------------	-----------------	---	--

### LARGE

#### SHN5703K

cm. L. 205 P. 221 | in. W. 80,70 D. 87,00 - Kg. 93 M³ 0,40  
PER RETE - FOR BED BASE: King size **195 x 205** | in. 76,77 x 80,70

4.450	4.630	6.150	4.050 Mt. L. 6,80	ACS5230K 669	-	
-------	-------	-------	----------------------	-----------------	---	--

#### SHN5713K

cm. L. 205 P. 231 | in. W. 80,70 D. 90,94 - Kg. 96 M³ 0,42  
PER RETE - FOR BED BASE: King special size **195 x 215** | in. 76,77 x 84,64

4.450	4.630	6.150	4.050 Mt. L. 6,80	ACS5240K 744	-	
-------	-------	-------	----------------------	-----------------	---	--

#### SHN5723K

cm. L. 210 P. 216 | in. W. 82,67 D. 85,03 - Kg. 100 M³ 0,45  
PER RETE - FOR BED BASE: King over size **200 x 200** | in. 78,74 x 78,74

4.450	4.630	6.150	4.050 Mt. L. 6,80	ACS5250K 776	-	
-------	-------	-------	----------------------	-----------------	---	--

### MAGGIORAZIONI - SURCHARGES

Contenitore  
Container box

650

Contenitore con sollevamento orizzontale  
Container box with horizontal lifting mechanism



222

**LETTI - SENZA RETE E MATERASSO**  
**BEDS - WITHOUT BED BASE AND MATTRESS**

**LETTO BIRKIN IMBOTTITO**

LETTO FLUTTUANTE CON GIROLETTO LEGNO E TESTATA IMBOTTITA  
POSSIBILITÀ DI PIEDI IN METALLO NERO IN ALTERNATIVA AL PIEDE IN VETRO

**PADDED BIRKIN BED**

FLOATING BED WITH WOODEN SURROUND AND PADDED HEADBOARD  
POSSIBILITY OF BLACK METAL FEET AS AN ALTERNATIVE TO THE GLASS FOOT

MISURE RETI DISPONIBILI - DIM. OF AVAILABLE BED BASES

**SMALL**

European size cm. 160 x 200 | in. 63,00 x 78,74  
Queen size cm. 155 x 205 | in. 61,02 x 80,70

**MEDIUM**

European special size cm. 180 x 200 | in. 70,86 x 78,74  
California special size cm. 185 x 215 | in. 72,83 x 84,64  
California size cm. 185 x 205 | in. 70,86 x 80,70

**LARGE**

King size cm. 195 x 205 | in. 76,77 x 80,70  
King special size cm. 195 x 215 | in. 76,77 x 84,64  
King over size cm. 200 x 200 | in. 78,74 x 78,74

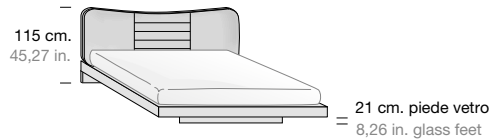

CAT. A	CAT. B	CAT. C	CAT. COM	RETE A DOGHE DI LEGNO WOODEN SLATTER BASE	OPTIONAL
ECOPELLE, ECONABUK FAUX LEATHER, ECONABUK	LINO, VELLUTO, BOUCLÉ LINEN, VELVET, BOUCLÉ	PELLE LEATHER	TESSUTO CLIENTE CUSTOMER'S FABRIC		CONTENITORE FLUTTUANTE CON RETE BASCULANTE FLOATING BOX STORAGE WITH TILTING NET

**SMALL**

**DEN5001K**

cm. L. 190 P. 212 | in. W. 74,80 D. 83,46 - Kg. 65 M³ 0,23  
PER RETE - FOR BED BASE: European size **160 x 200** | in. 63,00 x 78,74

2.850	2.950	3.450	2.700 Mt. L. 2,50	ACS5160K 433	ACS5101K Kg. 30 M³ 0,20 INTERNO - INTERNAL 124 x 183 h. 16 <b>1.900</b>
-------	-------	-------	----------------------	-----------------	--

**DEN5011K**

cm. L. 185 P. 217 | in. W. 72,83 D. 85,43 - Kg. 65 M³ 0,23  
PER RETE - FOR BED BASE: Queen size **155 x 205** | in. 61,02 x 80,70

2.850	2.950	3.450	2.700 Mt. L. 2,50	ACS5200K 637	-
-------	-------	-------	----------------------	-----------------	---

**MEDIUM**

**DEN5002K**

cm. L. 210 P. 212 | in. W. 82,67 D. 83,46 - Kg. 70 M³ 0,26  
PER RETE - FOR BED BASE: European special size **180 x 200** | in. 70,86 x 78,74

3.135	3.245	3.795	2.890 Mt. L. 2,70	ACS5180K 593	ACS5102K Kg. 40 M³ 0,22 INTERNO - INTERNAL 144 x 183 h. 16 <b>2.000</b>
-------	-------	-------	----------------------	-----------------	--

**DEN5012K**

cm. L. 215 P. 227 | in. W. 84,64 D. 89,37 - Kg. 75 M³ 0,30  
PER RETE - FOR BED BASE: California special size **185 x 215** | in. 72,83 x 84,64

3.135	3.245	3.795	2.890 Mt. L. 2,70	ACS5220K 696	-
-------	-------	-------	----------------------	-----------------	---

**DEN5022K**

cm. L. 215 P. 217 | in. W. 84,64 D. 85,43 - Kg. 75 M³ 0,28  
PER RETE - FOR BED BASE: California size **185 x 205** | in. 70,86 x 80,70

3.135	3.245	3.795	2.890 Mt. L. 2,70	ACS5210K 653	-
-------	-------	-------	----------------------	-----------------	---

**LARGE**

**DEN5003K**

cm. L. 225 P. 217 | in. W. 88,58 D. 85,43 - Kg. 80 M³ 0,32  
PER RETE - FOR BED BASE: King size **195 x 205** | in. 76,77 x 80,70

3.335	3.445	3.995	3.100 Mt. L. 2,90	ACS5230K 669	-
-------	-------	-------	----------------------	-----------------	---

**DEN5013K**

cm. L. 225 P. 227 | in. W. 88,58 D. 89,37 - Kg. 85 M³ 0,35  
PER RETE - FOR BED BASE: King special size **195 x 215** | in. 76,77 x 84,64

3.335	3.445	3.995	3.100 Mt. L. 2,90	ACS5240K 744	-
-------	-------	-------	----------------------	-----------------	---

**DEN5023K**

cm. L. 230 P. 217 | in. W. 90,55 D. 85,43 - Kg. 90 M³ 0,40  
PER RETE - FOR BED BASE: King over size **200 x 200** | in. 78,74 x 78,74

3.335	3.445	3.995	3.100 Mt. L. 2,90	ACS5250K 776	-
-------	-------	-------	----------------------	-----------------	---

# NOTTE - NIGHT

## LETTI - SENZA RETE E MATERASSO BEDS - WITHOUT BED BASE AND MATTRESS

### LETTO BIRKIN IMBOTTITO

LETTO FLUTTUANTE CON GIROLETTO E TESTATA IMBOTTITI

### PADDED BIRKIN BED

FLOATING BED WITH PADDED SURROUND AND HEADBOARD

MISURE RETI DISPONIBILI - DIM. OF AVAILABLE BED BASES

#### SMALL

European size cm. 160 x 200 | in. 63,00 x 78,74  
Queen size cm. 155 x 205 | in. 61,02 x 80,70

#### MEDIUM

European special size cm. 180 x 200 | in. 70,86 x 78,74  
California special size cm. 185 x 215 | in. 72,83 x 84,64  
California size cm. 185 x 205 | in. 70,86 x 80,70

#### LARGE

King size cm. 195 x 205 | in. 76,77 x 80,70  
King special size cm. 195 x 215 | in. 76,77 x 84,64  
King over size cm. 200 x 200 | in. 78,74 x 78,74

NEW



CAT. A	CAT. B	CAT. C	CAT. COM	RETE A DOGHE DI LEGNO WOODEN SLATTER BASE	OPTIONAL
ECOPELLE, ECONABUK FAUX LEATHER, ECONABUK	LINO, VELLUTO, BOUCLÉ LINEN, VELVET, BOUCLÉ	PELLE LEATHER	TESSUTO CLIENTE CUSTOMER'S FABRIC		CONTENITORE FLUTTUANTE CON RETE BASCULANTE FLOATING BOX STORAGE WITH TILTING NET

### SMALL

#### DEN5031K

cm. L. 190 P. 212 | in. W. 74,80 D. 83,46 - Kg. 80 M³ 0,30  
PER RETE - FOR BED BASE: European size **160 x 200** | in. 63,00 x 78,74

3.450

3.650

4.680

3.050  
Mt. L. 5,00

ACS5160K  
433

ACS5101K  
Kg. 30 M³ 0,20  
INTERNO - INTERNAL  
124 x 183 h. 16 **1.900**

#### DEN5041K

cm. L. 185 P. 217 | in. W. 72,83 D. 85,43 - Kg. 80 M³ 0,30  
PER RETE - FOR BED BASE: Queen size **155 x 205** | in. 61,02 x 80,70

3.450

3.650

4.680

3.050  
Mt. L. 5,00

ACS5200K  
637

-

### MEDIUM

#### DEN5032K

cm. L. 210 P. 212 | in. W. 82,67 D. 83,46 - Kg. 85 M³ 0,32  
PER RETE - FOR BED BASE: European special size **180 x 200** | in. 70,86 x 78,74

3.795

4.015

5.150

3.450  
Mt. L. 5,20

ACS5180K  
593

ACS5102K  
Kg. 40 M³ 0,22  
INTERNO - INTERNAL  
144 x 183 h. 16 **2.000**

#### DEN5042K

cm. L. 215 P. 227 | in. W. 84,64 D. 89,37 - Kg. 90 M³ 0,38  
PER RETE - FOR BED BASE: California special size **185 x 215** | in. 72,83 x 84,64

3.795

4.015

5.150

3.450  
Mt. L. 5,20

ACS5220K  
696

-

#### DEN5052K

cm. L. 215 P. 217 | in. W. 84,64 D. 85,43 - Kg. 88 M³ 0,36  
PER RETE - FOR BED BASE: California size **185 x 205** | in. 70,86 x 80,70

3.795

4.015

5.150

3.450  
Mt. L. 5,20

ACS5210K  
653

-

### LARGE

#### DEN5033K

cm. L. 225 P. 217 | in. W. 88,58 D. 85,43 - Kg. 93 M³ 0,40  
PER RETE - FOR BED BASE: King size **195 x 205** | in. 76,77 x 80,70

3.995

4.215

5.350

3.590  
Mt. L. 5,40

ACS5230K  
669

-

#### DEN5043K

cm. L. 225 P. 227 | in. W. 88,58 D. 89,37 - Kg. 96 M³ 0,42  
PER RETE - FOR BED BASE: King special size **195 x 215** | in. 76,77 x 84,64

3.995

4.215

5.350

3.590  
Mt. L. 5,40

ACS5240K  
744

-

#### DEN5053K

cm. L. 230 P. 217 | in. W. 90,55 D. 85,43 - Kg. 100 M³ 0,45  
PER RETE - FOR BED BASE: King over size **200 x 200** | in. 78,74 x 78,74

3.995

4.215

5.350

3.590  
Mt. L. 5,40

ACS5250K  
776

-

**LETTI - SENZA RETE E MATERASSO**  
**BEDS - WITHOUT BED BASE AND MATTRESS**

**LETTO PEDRERA**

LETTO FLUTTUANTE CON GIROLETTO LEGNO E CON TESTIERA TRAFORATA  
POSSIBILITÀ DI PIEDI IN METALLO NERO IN ALTERNATIVA AL PIEDE IN VETRO

**PEDRERA BED**

FLOATING BED WITH WOODEN SURROUND AND PERFORATED PANEL  
POSSIBILITY OF BLACK METAL FEET AS AN ALTERNATIVE TO THE GLASS FOOT

MISURE RETI DISPONIBILI - DIM. OF AVAILABLE BED BASES

**SMALL**

European size cm. 160 x 200 | in. 63,00 x 78,74

**MEDIUM**

European special size cm. 180 x 200 | in. 70,86 x 78,74

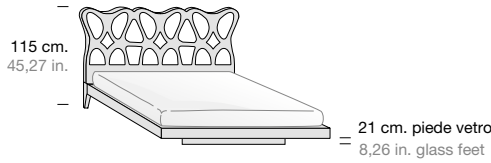

PREZZI PRICES	RETE A DOGHE DI LEGNO WOODEN SLATTER BASE	<b>OPTIONAL</b> CONTENITORE FLUTTUANTE CON RETE BASCULANTE FLOATING BOX STORAGE WITH TILTING NET

**SMALL**

**DEN5201K**

cm. L. 184 P. 209 | in. W. 72,44 D. 82,28 - Kg. 60 M<sup>3</sup> 0,17  
PER RETE - FOR BED BASE: European size **160 x 200** | in. 63,00 x 78,74

<b>4.900</b>	<b>ACS5160K</b> 433	<b>ACS5101K</b> Kg. 30 M <sup>3</sup> 0,20 INTERNO - INTERNAL 124 x 183 h. 16	<b>1.000</b>
--------------	------------------------	--	--------------

**MEDIUM**

**DEN5202K**

cm. L. 204 P. 209 | in. W. 80,31 D. 82,28 - Kg. 65 M<sup>3</sup> 0,19  
PER RETE - FOR BED BASE: European special size **cm. 180 x 200** | in. 70,86 x 78,74

<b>5.2 00</b>	<b>ACS5220K</b> 696	<b>ACS5102K</b> Kg. 40 M <sup>3</sup> 0,22 INTERNO - INTERNAL 144 x 183 h. 16	<b>2.000</b>
---------------	------------------------	--	--------------

**LETTO PEDRERA**

LETTO CON GIROLETTO LEGNO E CON TESTIERA TRAFORATA

**PEDRERA BED**

BED WITH WOODEN SURROUND AND PERFORATED PANEL

MISURE RETI DISPONIBILI - DIM. OF AVAILABLE BED BASES

**SMALL**

European size cm. 160 x 200 | in. 63,00 x 78,74

**MEDIUM**

European special size cm. 180 x 200 | in. 70,86 x 78,74



PREZZI PRICES	RETE A DOGHE DI LEGNO WOODEN SLATTER BASE	<b>OPTIONAL</b>

**SMALL**

**DEN5211K**

cm. L. 184 P. 209 | in. W. 72,44 D. 82,28 - Kg. 60 M<sup>3</sup> 0,17  
PER RETE - FOR BED BASE: European size **160 x 200** | in. 63,00 x 78,74

<b>4.950</b>	<b>ACS5160K</b> 433	-
--------------	------------------------	---

**MEDIUM**

**DEN5231K**

cm. L. 204 P. 209 | in. W. 80,31 D. 82,28 - Kg. 65 M<sup>3</sup> 0,19  
PER RETE - FOR BED BASE: European special size **cm. 180 x 200** | in. 70,86 x 78,74

<b>5.400</b>	<b>ACS5220K</b> 696	-
--------------	------------------------	---

**MAGGIORAZIONI - SURCHARGES**

Fascia imbottita su giroletto in legno  
Upholstered band on wooden bed surround

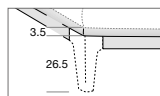

<b>CAT. A</b> ECOPELLE, ECONABUK FAUX LEATHER, ECONABUK	<b>CAT. B</b> LINO, VELLUTO, BOUCLÉ LINEN, VELVET, BOUCLÉ	<b>CAT. C</b> PELLE LEATHER	<b>CAT. COM</b> TESSUTO CLIENTE CUSTOMER'S FABRIC
<b>400</b>	<b>455</b>	<b>555</b>	<b>300</b> Mt. L. 2,00

# NOTTE - NIGHT

## LETTI - SENZA RETE E MATERASSO BEDS - WITHOUT BED BASE AND MATTRESS

### LETTO BUTTERFLY IMBOTTITO

LETTO CON GIROLETTO LEGNO E TESTATA IMBOTTITA

### PADDED BUTTERFLY BED

BED WITH WOODEN SURROUND AND PADDED HEADBOARD



### MISURE RETI DISPONIBILI - DIM. OF AVAILABLE BED BASES

#### SMALL

European size cm. 160 x 200 | in. 63,00 x 78,74  
Queen size cm. 155 x 205 | in. 61,02 x 80,70

#### MEDIUM

European special size cm. 180 x 200 | in. 70,86 x 78,74  
California special size cm. 185 x 215 | in. 72,83 x 84,64  
California size cm. 185 x 205 | in. 70,86 x 80,70

#### LARGE

King size cm. 195 x 205 | in. 76,77 x 80,70  
King special size cm. 195 x 215 | in. 76,77 x 84,64  
King over size cm. 200 x 200 | in. 78,74 x 78,74

	CAT. A ECOPELLE, ECONABUK FAUX LEATHER, ECONABUK	CAT. B LINO, VELLUTO, BOUCLÉ LINEN, VELVET, BOUCLÉ	CAT. C PELLE LEATHER	CAT. COM TESSUTO CLIENTE CUSTOMER'S FABRIC	RETE A DOGHE DI LEGNO WOODEN SLATTER BASE	OPTIONAL
--	--	--	----------------------------	--	--	----------

### SMALL

#### DON5701K

cm. L. 190 P. 212 | in. W. 74,80 D. 83,46 - Kg. 65 M³ 0,23  
PER RETE - FOR BED BASE: European size **cm. 160 x 200** | in. 63,00 x 78,74

2.550

2.650

2.950

2.450  
Mt. L. 2,50

ACS5160K  
433

-

#### DON5702K

cm. L. 175 P. 217 | in. W. 68,89 D. 85,43 - Kg. 80 M³ 0,30  
PER RETE - FOR BED BASE: Queen size **cm. 155 x 205** | in. 61,02 x 80,70

2.550

2.650

2.850

2.450  
Mt. L. 2,50

ACS5200K  
637

-

### MEDIUM

#### DON5741K

cm. L. 210 P. 212 | in. W. 82,67 D. 83,46 - Kg. 70 M³ 0,26  
PER RETE - FOR BED BASE: European special size **cm. 180 x 200** | in. 70,86 x 78,74

2.750

2.850

3.250

2.550  
Mt. L. 2,70

ACS5180K  
593

-

#### DON5742K

cm. L. 205 P. 227 | in. W. 80,70 D. 89,37 - Kg. 90 M³ 0,38  
PER RETE - FOR BED BASE: California special size **cm. 185 x 215** | in. 72,83 x 84,64

2.750

2.850

3.250

2.550  
Mt. L. 2,70

ACS5220K  
696

-

#### DON5743K

cm. L. 205 P. 217 | in. W. 80,70 D. 85,43 - Kg. 88 M³ 0,36  
PER RETE - FOR BED BASE: California size **cm. 185 x 205** | in. 70,86 x 80,70

2.750

2.850

3.250

2.550  
Mt. L. 2,70

ACS5210K  
653

-

### LARGE

#### DON5711K

cm. L. 215 P. 217 | in. W. 84,64 D. 85,43 - Kg. 93 M³ 0,40  
PER RETE - FOR BED BASE: King size **cm. 195 x 205** | in. 76,77 x 80,70

2.950

3.150

3.450

2.750  
Mt. L. 2,90

ACS5230K  
669

-

#### DON5712K

cm. L. 215 P. 227 | in. W. 84,64 D. 89,37 - Kg. 96 M³ 0,42  
PER RETE - FOR BED BASE: King special size **cm. 195 x 215** | in. 76,77 x 84,64

2.950

3.150

3.450

2.750  
Mt. L. 2,90

ACS5240K  
744

-

#### DON5713K

cm. L. 220 P. 212 | in. W. 86,61 D. 83,46 - Kg. 100 M³ 0,45  
PER RETE - FOR BED BASE: King over size **cm. 200 x 200** | in. 78,74 x 78,74

2.950

3.150

3.450

2.750  
Mt. L. 2,90

ACS5250K  
776

-

### MAGGIORAZIONI - SURCHARGES

Fascia imbottita su giroletto in legno  
Upholstered band on wooden bed surround

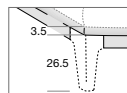

400

455

555

300  
Mt. L. 2,00

**LETTI - SENZA RETE E MATERASSO**  
**BEDS - WITHOUT BED BASE AND MATTRESS**

**LETTO BUTTERFLY IMBOTTITO**

LETTO CON GIROLETTO E TESTIERA IMBOTTITI

**PADDED BUTTERFLY BED**

BED WITH PADDED HEADBOARD AND BED SURROUND

MISURE RETI DISPONIBILI - DIM. OF AVAILABLE BED BASES

**SMALL**

European size cm. 160 x 200 | in. 63,00 x 78,74  
Queen size cm. 155 x 205 | in. 61,02 x 80,70

**MEDIUM**

European special size cm. 180 x 200 | in. 70,86 x 78,74  
California special size cm. 185 x 215 | in. 72,83 x 84,64  
California size cm. 185 x 205 | in. 70,86 x 80,70

**LARGE**

King size cm. 195 x 205 | in. 76,77 x 80,70  
King special size cm. 195 x 215 | in. 76,77 x 84,64  
King over size cm. 200 x 200 | in. 78,74 x 78,74



CAT. A	CAT. B	CAT. C	CAT. COM	RETE A DOGHE DI LEGNO WOODEN SLATTER BASE	OPTIONAL
ECOPELLE, ECONABUK FAUX LEATHER, ECONABUK	LINO, VELLUTO, BOUCLÉ LINEN, VELVET, BOUCLÉ	PELLE LEATHER	TESSUTO CLIENTE CUSTOMER'S FABRIC		CONTENITORE CON RETE BASCULANTE BOX STORAGE WITH TILTING NET

**SMALL**

**DON5731K**

cm. L. 190 P. 214 | in. W. 74,80 D. 84,25 - Kg. 85 M³ 0,31  
PER RETE - FOR BED BASE: European size **160 x 200** | in. 63,00 x 78,74

3.150	3.400	3.750	2.700 Mt. L. 5,00	ACS5160K 433	Kg. 66 M³ 0,40 INTERNO - INTERNAL 162 x 202 h. 16	680
-------	-------	-------	----------------------	-----------------	---	-----

**DON5732K**

cm. L. 175 P. 219 | in. W. 68,89 D. 86,22 - Kg. 80 M³ 0,30  
PER RETE - FOR BED BASE: Queen size **155 x 205** | in. 61,02 x 80,70

3.150	3.400	3.750	2.700 Mt. L. 5,00	ACS5200K 637	-	
-------	-------	-------	----------------------	-----------------	---	--

**MEDIUM**

**DON5761K**

cm. L. 210 P. 214 | in. W. 82,67 D. 84,25 - Kg. 100 M³ 0,35  
PER RETE - FOR BED BASE: European special size **180 x 200** | in. 70,86 x 78,74

3.350	3.600	3.950	2.900 Mt. L. 5,20	ACS5180K 593	Kg. 66 M³ 0,40 INTERNO - INTERNAL 182 x 202 h. 16	750
-------	-------	-------	----------------------	-----------------	---	-----

**DON5762K**

cm. L. 215 P. 229 | in. W. 84,64 D. 90,15 - Kg. 90 M³ 0,38  
PER RETE - FOR BED BASE: California special size **185 x 215** | in. 72,83 x 84,64

3.350	3.600	3.950	2.900 Mt. L. 5,20	ACS5220K 696	-	
-------	-------	-------	----------------------	-----------------	---	--

**DON5763K**

cm. L. 205 P. 219 | in. W. 80,70 D. 86,22 - Kg. 88 M³ 0,36  
PER RETE - FOR BED BASE: California size **185 x 205** | in. 70,86 x 80,70

3.350	3.600	3.950	2.900 Mt. L. 5,20	ACS5210K 653	-	
-------	-------	-------	----------------------	-----------------	---	--

**LARGE**

**DON5781K**

cm. L. 215 P. 219 | in. W. 84,64 D. 86,22 - Kg. 93 M³ 0,40  
PER RETE - FOR BED BASE: King size **195 x 205** | in. 76,77 x 80,70

3.550	3.800	4.150	3.100 Mt. L. 5,40	ACS5230K 669	-	
-------	-------	-------	----------------------	-----------------	---	--

**DON5782K**

cm. L. 215 P. 229 | in. W. 84,64 D. 90,15 - Kg. 96 M³ 0,42  
PER RETE - FOR BED BASE: King special size **195 x 215** | in. 76,77 x 84,64

3.550	3.800	4.150	3.100 Mt. L. 5,40	ACS5240K 744	-	
-------	-------	-------	----------------------	-----------------	---	--

**DON5783K**

cm. L. 220 P. 214 | in. W. 86,61 D. 84,25 - Kg. 100 M³ 0,45  
PER RETE - FOR BED BASE: King over size **200 x 200** | in. 78,74 x 78,74

3.550	3.800	4.150	3.100 Mt. L. 5,40	ACS5250K 776	-	
-------	-------	-------	----------------------	-----------------	---	--

**MAGGIORAZIONI - SURCHARGES**

Contenitore  
Container box

650

Contenitore con sollevamento orizzontale  
Container box with horizontal lifting mechanism

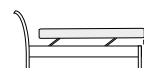

222

# NOTTE - NIGHT

## LETTI - SENZA RETE E MATERASSO BEDS - WITHOUT BED BASE AND MATTRESS

### LETTO BUTTERFLY IMBOTTITO

LETTO FLUTTUANTE CON GIROLETTO E TESTIERA IMBOTTITI

#### PADDED BUTTERFLY BED

FLOATING BED WITH PADDED HEADBOARD AND BED SURROUND



#### MISURE RETI DISPONIBILI - DIM. OF AVAILABLE BED BASES

##### SMALL

European size cm. 160 x 200 | in. 63,00 x 78,74  
Queen size cm. 155 x 205 | in. 61,02 x 80,70

##### MEDIUM

European special size cm. 180 x 200 | in. 70,86 x 78,74  
California special size cm. 185 x 215 | in. 72,83 x 84,64  
California size cm. 185 x 205 | in. 70,86 x 80,70

##### LARGE

King size cm. 195 x 205 | in. 76,77 x 80,70  
King special size cm. 195 x 215 | in. 76,77 x 84,64  
King over size cm. 200 x 200 | in. 78,74 x 78,74

	CAT. A ECOPELLE, ECONABUK FAUX LEATHER, ECONABUK	CAT. B LINO, VELLUTO, BOUCLÉ LINEN, VELVET, BOUCLÉ	CAT. C PELLE LEATHER	CAT. COM TESSUTO CLIENTE CUSTOMER'S FABRIC	RETE A DOGHE DI LEGNO WOODEN SLATTER BASE	OPTIONAL CONTENITORE FLUTTUANTE CON RETE BASCULANTE FLOATING BOX STORAGE WITH TILTING NET
--	--	--	----------------------------	--	--	---

### SMALL

#### DEN5801K

cm. L. 190 P. 214 | in. W. 74,80 D. 84,25 - Kg. 85 M<sup>3</sup> 0,31  
PER RETE - FOR BED BASE: European size **cm. 160 x 200** | in. 63,00 x 78,74

2.950

3.200

3.550

2.500  
Mt. L. 5,00

ACS5160K  
433

ACS5101K  
Kg. 30 M<sup>3</sup> 0,20  
INTERNO - INTERNAL  
124 x 183 h. 16 **1.900**

#### DEN5811K

cm. L. 175 P. 219 | in. W. 68,89 D. 86,22 - Kg. 80 M<sup>3</sup> 0,30  
PER RETE - FOR BED BASE: Queen size **cm. 155 x 205** | in. 61,02 x 80,70

2.950

3.200

3.550

2.500  
Mt. L. 5,00

ACS5200K  
637

-

### MEDIUM

#### DEN5802K

cm. L. 210 P. 214 | in. W. 82,67 D. 84,25 - Kg. 100 M<sup>3</sup> 0,35  
PER RETE - FOR BED BASE: European special size **cm. 180 x 200** | in. 70,86 x 78,74

3.150

3.400

3.750

2.700  
Mt. L. 5,20

ACS5180K  
593

ACS5102K  
Kg. 40 M<sup>3</sup> 0,22  
INTERNO - INTERNAL  
144 x 183 h. 16 **2.000**

#### DEN5812K

cm. L. 215 P. 229 | in. W. 84,64 D. 90,15 - Kg. 90 M<sup>3</sup> 0,38  
PER RETE - FOR BED BASE: California special size **cm. 185 x 215** | in. 72,83 x 84,64

3.150

3.400

3.750

2.700  
Mt. L. 5,20

ACS5220K  
696

-

#### DEN5822K

cm. L. 205 P. 219 | in. W. 80,70 D. 86,22 - Kg. 88 M<sup>3</sup> 0,36  
PER RETE - FOR BED BASE: California size **cm. 185 x 205** | in. 70,86 x 80,70

3.150

3.400

3.750

2.700  
Mt. L. 5,20

ACS5210K  
653

-

### LARGE

#### DEN5803K

cm. L. 215 P. 219 | in. W. 84,64 D. 86,22 - Kg. 93 M<sup>3</sup> 0,40  
PER RETE - FOR BED BASE: King size **cm. 195 x 205** | in. 76,77 x 80,70

3.350

3.600

3.950

3.900  
Mt. L. 5,40

ACS5230K  
669

-

#### DEN5813K

cm. L. 215 P. 229 | in. W. 84,64 D. 90,15 - Kg. 96 M<sup>3</sup> 0,42  
PER RETE - FOR BED BASE: King special size **cm. 195 x 215** | in. 76,77 x 84,64

3.350

3.600

3.950

3.900  
Mt. L. 5,40

ACS5240K  
744

-

#### DEN5823K

cm. L. 220 P. 214 | in. W. 86,61 D. 84,25 - Kg. 100 M<sup>3</sup> 0,45  
PER RETE - FOR BED BASE: King over size **cm. 200 x 200** | in. 78,74 x 78,74

3.350

3.600

3.950

3.900  
Mt. L. 5,40

ACS5250K  
776

-

### MAGGIORAZIONI - SURCHARGES

Contenitore  
Container box

650

Contenitore con sollevamento orizzontale  
Container box with horizontal lifting mechanism



222



**LETTI - SENZA RETE E MATERASSO**  
**BEDS - WITHOUT BED BASE AND MATTRESS**

**LETTO TOBIA IMBOTTITO**

LETTO CON GIROLETTO LEGNO E TESTATA IMBOTTITA

**PADDED TOBIA BED**

BED WITH WOODEN SURROUND AND PADDED HEADBOARD

MISURE RETI DISPONIBILI - DIM. OF AVAILABLE BED BASES

**SMALL**

European size cm. 160 x 200 | in. 63,00 x 78,74  
Queen size cm. 155 x 205 | in. 61,02 x 80,70

**MEDIUM**

European special size cm. 180 x 200 | in. 70,86 x 78,74  
California special size cm. 185 x 215 | in. 72,83 x 84,64  
California size cm. 185 x 205 | in. 70,86 x 80,70

**LARGE**

King size cm. 195 x 205 | in. 76,77 x 80,70  
King special size cm. 195 x 215 | in. 76,77 x 84,64  
King over size cm. 200 x 200 | in. 78,74 x 78,74



CAT. A	CAT. B	CAT. C	CAT. COM	OPTIONAL
ECOPELLE, ECONABUK FAUX LEATHER, ECONABUK	LINO, VELLUTO, BOUCLE LINEN, VELVET, BOUCLE	PELLE LEATHER	TESSUTO CLIENTE CUSTOMER'S FABRIC	RETE A DOGHE DI LEGNO WOODEN SLATTER BASE

**SMALL**

**DON5011K**

cm. L. 178 P. 212 | in. W. 70,07 D. 83,46 - Kg. 65 M³ 0,23  
PER RETE - FOR BED BASE: European size **160 x 200** | in. 63,00 x 78,74

2.450	2.600	3.290	2.300 Mt. L. 4,00	ACS5160K 433	-
-------	-------	-------	----------------------	-----------------	---

**DON5012K**

cm. L. 173 P. 217 | in. W. 68,11 D. 85,43 - Kg. 80 M³ 0,30  
PER RETE - FOR BED BASE: Queen size **155 x 205** | in. 61,02 x 80,70

2.450	2.600	3.290	3.290 Mt. L. 4,00	ACS5200K 637	-
-------	-------	-------	----------------------	-----------------	---

**MEDIUM**

**DON5041K**

cm. L. 198 P. 212 | in. W. 77,95 D. 83,46 - Kg. 70 M³ 0,26  
PER RETE - FOR BED BASE: European special size **180 x 200** | in. 70,86 x 78,74

2.600	2.700	3.950	2.300 Mt. L. 4,20	ACS5180K 593	-
-------	-------	-------	----------------------	-----------------	---

**DON5042K**

cm. L. 203 P. 227 | in. W. 79,92 D. 89,37 - Kg. 90 M³ 0,38  
PER RETE - FOR BED BASE: California special size **185 x 215** | in. 72,83 x 84,64

2.600	2.700	3.950	2.300 Mt. L. 4,20	ACS5220K 696	-
-------	-------	-------	----------------------	-----------------	---

**DON5043K**

cm. L. 203 P. 217 | in. W. 79,92 D. 85,43 - Kg. 88 M³ 0,36  
PER RETE - FOR BED BASE: California size **185 x 205** | in. 70,86 x 80,70

2.600	2.700	3.950	2.300 Mt. L. 4,20	ACS5210K 653	-
-------	-------	-------	----------------------	-----------------	---

**LARGE**

**DON5071K**

cm. L. 213 P. 217 | in. W. 83,86 D. 85,43 - Kg. 93 M³ 0,40  
PER RETE - FOR BED BASE: King size **195 x 205** | in. 76,77 x 80,70

2.750	2.850	4.000	2.450 Mt. L. 4,40	ACS5230K 669	-
-------	-------	-------	----------------------	-----------------	---

**DON5072K**

cm. L. 213 P. 227 | in. W. 83,86 D. 89,37 - Kg. 96 M³ 0,42  
PER RETE - FOR BED BASE: King special size **195 x 215** | in. 76,77 x 84,64

2.750	2.850	4.000	2.450 Mt. L. 4,40	ACS5240K 744	-
-------	-------	-------	----------------------	-----------------	---

**DON5073K**

cm. L. 218 P. 212 | in. W. 85,83 D. 83,46 - Kg. 100 M³ 0,45  
PER RETE - FOR BED BASE: King over size **200 x 200** | in. 78,74 x 78,74

2.750	2.850	4.000	2.450 Mt. L. 4,40	ACS5250K 776	-
-------	-------	-------	----------------------	-----------------	---

**MAGGIORAZIONI - SURCHARGES**

Fascia imbottita su giroletto in legno  
Upholstered band on wooden bed surround

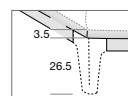

400	455	555	300 Mt. L. 2,00		
-----	-----	-----	--------------------	--	--

# NOTTE - NIGHT

## LETTI - SENZA RETE E MATERASSO BEDS - WITHOUT BED BASE AND MATTRESS

### LETTO TOBIA IMBOTTITO

LETTO FLUTTUANTE CON GIROLETTO E TESTATA IMBOTTITI

### PADDED TOBIA BED

FLOATING BED WITH PADDED SURROUND AND HEADBOARD

MISURE RETI DISPONIBILI - DIM. OF AVAILABLE BED BASES

#### SMALL

European size cm. 160 x 200 | in. 63,00 x 78,74  
Queen size cm. 155 x 205 | in. 61,02 x 80,70

#### MEDIUM

European special size cm. 180 x 200 | in. 70,86 x 78,74  
California special size cm. 185 x 215 | in. 72,83 x 84,64  
California size cm. 185 x 205 | in. 70,86 x 80,70

#### LARGE

King size cm. 195 x 205 | in. 76,77 x 80,70  
King special size cm. 195 x 215 | in. 76,77 x 84,64  
King over size cm. 200 x 200 | in. 78,74 x 78,74



CAT. A	CAT. B	CAT. C	CAT. COM	OPTIONAL
ECOPELLE, ECONABUK FAUX LEATHER, ECONABUK	LINO, VELLUTO, BOUCLÉ LINEN, VELVET, BOUCLÉ	PELLE LEATHER	TESSUTO CLIENTE CUSTOMER'S FABRIC	RETE A DOGHE DI LEGNO WOODEN SLATTER BASE

### SMALL

#### DEN5701K

cm. L. 178 P. 212 | in. W. 70,07 D. 83,46 - Kg. 65 M³ 0,23  
PER RETE - FOR BED BASE: European size **cm. 160 x 200** | in. 63,00 x 78,74

3.100

3.450

4.450

2.950  
Mt. L. 4,00

ACS5160K  
433

-

#### DEN5711K

cm. L. 173 P. 225 | in. W. 68,11 D. 85,43 - Kg. 80 M³ 0,30  
PER RETE - FOR BED BASE: Queen size **cm. 155 x 205** | in. 61,02 x 80,70

3.100

3.450

4.450

2.950  
Mt. L. 4,00

ACS5200K  
637

-

### MEDIUM

#### DEN5702K

cm. L. 198 P. 212 | in. W. 77,95 D. 83,46 - Kg. 70 M³ 0,26  
PER RETE - FOR BED BASE: European special size **cm. 180 x 200** | in. 70,86 x 78,74

3.550

3.700

4.550

3.200  
Mt. L. 4,20

ACS5180K  
593

-

#### DEN5712K

cm. L. 203 P. 227 | in. W. 79,92 D. 89,37 - Kg. 90 M³ 0,38  
PER RETE - FOR BED BASE: California special size **cm. 185 x 215** | in. 72,83 x 84,64

3.550

3.700

4.550

3.200  
Mt. L. 4,20

ACS5220K  
696

-

#### DEN5722K

cm. L. 203 P. 217 | in. W. 79,92 D. 85,43 - Kg. 88 M³ 0,36  
PER RETE - FOR BED BASE: California size **cm. 185 x 205** | in. 70,86 x 80,70

3.550

3.700

4.550

3.200  
Mt. L. 4,20

ACS5210K  
653

-

### LARGE

#### DEN5703K

cm. L. 213 P. 217 | in. W. 83,86 D. 85,43 - Kg. 93 M³ 0,40  
PER RETE - FOR BED BASE: King size **cm. 195 x 205** | in. 76,77 x 80,70

3.750

3.950

4.950

3.500  
Mt. L. 4,40

ACS5230K  
669

-

#### DEN5713K

cm. L. 213 P. 227 | in. W. 83,86 D. 89,37 - Kg. 96 M³ 0,42  
PER RETE - FOR BED BASE: King special size **cm. 195 x 215** | in. 76,77 x 84,64

3.750

3.950

4.950

3.500  
Mt. L. 4,40

ACS5240K  
744

-

#### DEN5723K

cm. L. 218 P. 212 | in. W. 85,83 D. 83,46 - Kg. 100 M³ 0,45  
PER RETE - FOR BED BASE: King over size **cm. 200 x 200** | in. 78,74 x 78,74

3.750

3.950

4.950

3.500  
Mt. L. 4,40

ACS5250K  
776

-

**LETTI - SENZA RETE E MATERASSO**  
**BEDS - WITHOUT BED BASE AND MATTRESS**

**LETTO TOBIA IMBOTTITO**

LETTO CON GIROLETTO E TESTIERA IMBOTTITI

**PADDED TOBIA BED**

BED WITH PADDED HEADBOARD AND BED SURROUND

MISURE RETI DISPONIBILI - DIM. OF AVAILABLE BED BASES

**SMALL**

European size cm. 160 x 200 | in. 63,00 x 78,74  
Queen size cm. 155 x 205 | in. 61,02 x 80,70

**MEDIUM**

European special size cm. 180 x 200 | in. 70,86 x 78,74  
California special size cm. 185 x 215 | in. 72,83 x 84,64  
California size cm. 185 x 205 | in. 70,86 x 80,70

**LARGE**

King size cm. 195 x 205 | in. 76,77 x 80,70  
King special size cm. 195 x 215 | in. 76,77 x 84,64  
King over size cm. 200 x 200 | in. 78,74 x 78,74

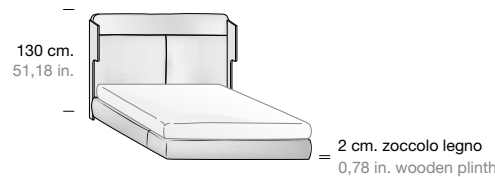

CAT. A	CAT. B	CAT. C	CAT. COM	OPTIONAL
ECOPELLE, ECONABUK FAUX LEATHER, ECONABUK	LINO, VELLUTO, BOUCLÉ LINEN, VELVET, BOUCLÉ	PELLE LEATHER	TESSUTO CLIENTE CUSTOMER'S FABRIC	RETE A DOGHE DI LEGNO WOODEN SLATTER BASE  CONTENITORE CON RETE BASCULANTE BOX STORAGE WITH TILTING NET

**SMALL**

**DON5031K**

cm. L. 178 P. 212 | in. W. 70,07 D. 83,46 - Kg. 85 M³ 0,31  
PER RETE - FOR BED BASE: European size **160 x 200** | in. 63,00 x 78,74

3.300	3.650	4.650	3.150 Mt. L. 6,50	ACS5160K 433	Kg. 66 M³ 0,40 INTERNO - INTERNAL 162 x 202 h. 16	680
-------	-------	-------	----------------------	-----------------	---	-----

**DON5032K**

cm. L. 173 P. 225 | in. W. 68,11 D. 88,58 - Kg. 80 M³ 0,30  
PER RETE - FOR BED BASE: Queen size **155 x 205** | in. 61,02 x 80,70

3.300	3.650	4.650	3.150 Mt. L. 6,50	ACS5200K 637	-	
-------	-------	-------	----------------------	-----------------	---	--

**MEDIUM**

**DON5061K**

cm. L. 198 P. 212 | in. W. 77,95 D. 83,46 - Kg. 100 M³ 0,35  
PER RETE - FOR BED BASE: European special size **180 x 200** | in. 70,86 x 78,74

3.750	3.900	4.750	3.400 Mt. L. 6,70	ACS5180K 593	Kg. 66 M³ 0,40 INTERNO - INTERNAL 182 x 202 h. 16	750
-------	-------	-------	----------------------	-----------------	---	-----

**DON5062K**

cm. L. 203 P. 227 | in. W. 79,92 D. 89,37 - Kg. 90 M³ 0,38  
PER RETE - FOR BED BASE: California special size **185 x 215** | in. 72,83 x 84,64

3.750	3.900	4.750	3.400 Mt. L. 6,70	ACS5220K 696	-	
-------	-------	-------	----------------------	-----------------	---	--

**DON5063K**

cm. L. 203 P. 217 | in. W. 79,92 D. 85,43 - Kg. 88 M³ 0,36  
PER RETE - FOR BED BASE: California size **185 x 205** | in. 70,86 x 80,70

3.750	3.900	4.750	3.400 Mt. L. 6,70	ACS5210K 653	-	
-------	-------	-------	----------------------	-----------------	---	--

**LARGE**

**DON5091K**

cm. L. 213 P. 217 | in. W. 83,86 D. 85,43 - Kg. 93 M³ 0,40  
PER RETE - FOR BED BASE: King size **195 x 205** | in. 76,77 x 80,70

3.950	4.300	5.150	3.800 Mt. L. 6,90	ACS5230K 669	-	
-------	-------	-------	----------------------	-----------------	---	--

**DON5092K**

cm. L. 213 P. 227 | in. W. 83,86 D. 89,37 - Kg. 96 M³ 0,42  
PER RETE - FOR BED BASE: King special size **195 x 215** | in. 76,77 x 84,64

3.950	4.300	5.150	3.800 Mt. L. 6,90	ACS5240K 744	-	
-------	-------	-------	----------------------	-----------------	---	--

**DON5093K**

cm. L. 218 P. 212 | in. W. 85,83 D. 83,46 - Kg. 100 M³ 0,45  
PER RETE - FOR BED BASE: King over size **200 x 200** | in. 78,74 x 78,74

3.950	4.300	5.150	3.800 Mt. L. 6,90	ACS5250K 776	-	
-------	-------	-------	----------------------	-----------------	---	--

**MAGGIORAZIONI - SURCHARGES**

Contenitore  
Container box

650

Contenitore con sollevamento orizzontale  
Container box with horizontal lifting mechanism

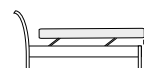

222

# NOTTE - NIGHT

## LETTI - SENZA RETE E MATERASSO BEDS - WITHOUT BED BASE AND MATTRESS

### LETTO DOMINO IMBOTTITO

LETTO CON GIROLETTO LEGNO E TESTIERA IMBOTTITA A DOGHE. TESTIERA CON 1 DOGA IN LEGNO LISCIA

#### PADDED DOMINO BED

BED WITH SLATTED PADDED HEADBOARD AND WOODEN BED SURROUND. HEADBOARD WITH 1 SMOOTH WOODEN SLAT

#### MISURE RETI DISPONIBILI - DIM. OF AVAILABLE BED BASES

##### SMALL

European size cm. 160 x 200 | in. 63,00 x 78,74  
Queen size cm. 155 x 205 | in. 61,02 x 80,70

##### MEDIUM

European special size cm. 180 x 200 | in. 70,86 x 78,74  
California special size cm. 185 x 215 | in. 72,83 x 84,64  
California size cm. 185 x 205 | in. 70,86 x 80,70

##### LARGE

King size cm. 195 x 205 | in. 76,77 x 80,70  
King special size cm. 195 x 215 | in. 76,77 x 84,64  
King over size cm. 200 x 200 | in. 78,74 x 78,74



	CAT. A ECOPELLE, ECONABUK FAUX LEATHER, ECONABUK	CAT. B LINO, VELLUTO, BOUCLÉ LINEN, VELVET, BOUCLÉ	CAT. C PELLE LEATHER	CAT. COM TESSUTO CLIENTE CUSTOMER'S FABRIC	RETE A DOGHE DI LEGNO WOODEN SLATTER BASE	OPTIONAL
--	--	--	----------------------------	--	--	----------

### SMALL

#### DON5506K

cm. L. 172 P. 210 | in. W. 67,71 D. 82,67 - Kg. 65 M³ 0,25  
PER RETE - FOR BED BASE: European size **160 x 200** | in. 63,00 x 78,74

2.700

2.900

3.250

2.600  
Mt. L. 1,80

ACS5160K  
433

-

#### DON5507K

cm. L. 167 P. 215 | in. W. 65,75 D. 84,65 - Kg. 80 M³ 0,30  
PER RETE - FOR BED BASE: Queen size **155 x 205** | in. 61,02 x 80,70

2.700

2.900

3.250

2.600  
Mt. L. 1,80

ACS5200K  
637

-

### MEDIUM

#### DON5586K

cm. L. 192 P. 210 | in. W. 75,59 D. 82,67 - Kg. 75 M³ 0,28  
PER RETE - FOR BED BASE: European special size **180 x 200** | in. 70,86 x 78,74

2.900

3.000

3.450

2.700  
Mt. L. 2,00

ACS5180K  
593

-

#### DON5587K

cm. L. 197 P. 225 | in. W. 77,56 D. 88,58 - Kg. 90 M³ 0,38  
PER RETE - FOR BED BASE: California special size **185 x 215** | in. 72,83 x 84,64

2.900

3.000

3.450

2.700  
Mt. L. 2,00

ACS5220K  
696

-

#### DON5588K

cm. L. 197 P. 215 | in. W. 77,56 D. 84,65 - Kg. 88 M³ 0,36  
PER RETE - FOR BED BASE: California size **185 x 205** | in. 70,86 x 80,70

2.900

3.000

3.450

2.700  
Mt. L. 2,00

ACS5210K  
653

-

### LARGE

#### DON5516K

cm. L. 207 P. 215 | in. W. 81,50 D. 84,65 - Kg. 93 M³ 0,40  
PER RETE - FOR BED BASE: King size **195 x 205** | in. 76,77 x 80,70

3.100

3.200

3.650

2.950  
Mt. L. 2,20

ACS5230K  
669

-

#### DON5517K

cm. L. 207 P. 225 | in. W. 81,50 D. 88,58 - Kg. 96 M³ 0,42  
PER RETE - FOR BED BASE: King special size **195 x 215** | in. 76,77 x 84,64

3.100

3.200

3.650

2.950  
Mt. L. 2,20

ACS5240K  
744

-

#### DON5518K

cm. L. 212 P. 210 | in. W. 83,46 D. 82,67 - Kg. 100 M³ 0,45  
PER RETE - FOR BED BASE: King over size **200 x 200** | in. 78,74 x 78,74

3.100

3.200

3.650

2.950  
Mt. L. 2,20

ACS5250K  
776

-

### MAGGIORAZIONI - SURCHARGES

Doga a righe Stripped slat	55				
Doga rivestita Upholstered slat	105	112	173	100 Mt. L. 1,00	
Fascia imbottita su giroletto in legno Upholstered band on wooden bed surround	400	455	555	300 Mt. L. 1,00	
Testata rivestita a doghe multicolori Headboard with multicolor upholstery	+ 5%				

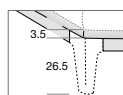

**LETTI - SENZA RETE E MATERASSO**  
**BEDS - WITHOUT BED BASE AND MATTRESS**

**LETTO DOMINO IMBOTTITO**

LETTO CON GIROLETTO IMBOTTITO E TESTIERA IMBOTTITA A DOGHE. TESTIERA CON 1 DOGA IN LEGNO LISCIA

**PADDED DOMINO BED**

BED WITH SLATTED PADDED HEADBOARD AND UPHOLSTERED BED SURROUND. HEADBOARD WITH 1 SMOOTH WOODEN SLAT

MISURE RETI DISPONIBILI - DIM. OF AVAILABLE BED BASES

**SMALL**

European size cm. 160 x 200 | in. 63,00 x 78,74  
Queen size cm. 155 x 205 | in. 61,02 x 80,70

**MEDIUM**

European special size cm. 180 x 200 | in. 70,86 x 78,74  
California special size cm. 185 x 215 | in. 72,83 x 84,64  
California size cm. 185 x 205 | in. 70,86 x 80,70

**LARGE**

King size cm. 195 x 205 | in. 76,77 x 80,70  
King special size cm. 195 x 215 | in. 76,77 x 84,64  
King over size cm. 200 x 200 | in. 78,74 x 78,74



	CAT. A ECOPELLE, ECONABUK FAUX LEATHER, ECONABUK	CAT. B LINO, VELLUTO, BOUCLÉ LINEN, VELVET, BOUCLÉ	CAT. C PELLE LEATHER	CAT. COM TESSUTO CLIENTE CUSTOMER'S FABRIC	RETE A DOGHE DI LEGNO WOODEN SLATTER BASE	OPTIONAL CONTENITORE CON RETE BASCULANTE BOX STORAGE WITH TILTING NET
--	--	--	----------------------------	--	--	---

**SMALL**

**DON5546K**

cm. L. 172 P. 210 | in. W. 67,71 D. 82,67 - Kg. 85 M³ 0,33  
PER RETE - FOR BED BASE: European size **160 x 200** | in. 63,00 x 78,74

3.100

3.250

3.650

2,900  
Mt. L. 4,30

ACS5160K  
433

Kg. 66 M³ 0,40  
INTERNO - INTERNAL  
162 x 202 h. 16

680

**DON5547K**

cm. L. 167 P. 215 | in. W. 65,75 D. 84,65 - Kg. 80 M³ 0,30  
PER RETE - FOR BED BASE: Queen size **155 x 205** | in. 61,02 x 80,70

3.100

3.250

3.650

2,900  
Mt. L. 4,30

ACS5200K  
637

-

**MEDIUM**

**DON5596K**

cm. L. 192 P. 210 | in. W. 75,59 D. 82,67 - Kg. 95 M³ 0,37  
PER RETE - FOR BED BASE: European special size **180 x 200** | in. 70,86 x 78,74

3.300

3.450

3.850

3.100  
Mt. L. 4,50

ACS5180K  
593

Kg. 66 M³ 0,40  
INTERNO - INTERNAL  
182 x 202 h. 16

750

**DON5597K**

cm. L. 197 P. 225 | in. W. 77,56 D. 88,58 - Kg. 90 M³ 0,38  
PER RETE - FOR BED BASE: California special size **185 x 215** | in. 72,83 x 84,64

3.300

3.450

3.850

3.100  
Mt. L. 4,50

ACS5220K  
696

-

**DON5598K**

cm. L. 197 P. 215 | in. W. 77,56 D. 84,65 - Kg. 88 M³ 0,36  
PER RETE - FOR BED BASE: California size **185 x 205** | in. 70,86 x 80,70

3.300

3.450

3.850

3.100  
Mt. L. 4,50

ACS5210K  
653

-

**LARGE**

**DON5546K**

cm. L. 207 P. 215 | in. W. 81,50 D. 84,65 - Kg. 93 M³ 0,40  
PER RETE - FOR BED BASE: King size **195 x 205** | in. 76,77 x 80,70

3.500

3.650

4.150

3.300  
Mt. L. 4,70

ACS5230K  
669

-

**DON5547K**

cm. L. 207 P. 225 | in. W. 81,50 D. 88,58 - Kg. 96 M³ 0,42  
PER RETE - FOR BED BASE: King special size **195 x 215** | in. 76,77 x 84,64

3.500

3.650

4.150

3.300  
Mt. L. 4,70

ACS5240K  
744

-

**DON5548K**

cm. L. 212 P. 210 | in. W. 83,46 D. 82,67 - Kg. 100 M³ 0,45  
PER RETE - FOR BED BASE: King over size **200 x 200** | in. 78,74 x 78,74

3.500

3.650

4.150

3.300  
Mt. L. 4,70

ACS5250K  
776

-

**MAGGIORAZIONI - SURCHARGES**

Doga a righe  
Stripped slat

55

Doga rivestita  
Upholstered slat

105

112

173

100  
Mt. L. 1,00

Testata rivestita a doghe multicolori  
Headboard with multicolor upholstery

+ 5%

Contenitore  
Container box

650

Contenitore con sollevamento orizzontale  
Container box with horizontal lifting mechanism

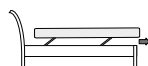

222

# NOTTE - NIGHT

## LETTI - SENZA RETE E MATERASSO BEDS - WITHOUT BED BASE AND MATTRESS

### LETTO SHANGHAI IMBOTTITO

LETTO CON GIROLETTO LEGNO E TESTIERA PAGLIA DI VIENNA E IMBOTTITA

### PADDED SHANGHAI BED

BED WITH WITH 'VIENNA STRAW' AND PADDED HEADBOARD AND WOODEN BED SURROUND



### MISURE RETI DISPONIBILI - DIM. OF AVAILABLE BED BASES

#### SMALL

European size cm. 160 x 200 | in. 63,00 x 78,74  
Queen size cm. 155 x 205 | in. 61,02 x 80,70

#### MEDIUM

European special size cm. 180 x 200 | in. 70,86 x 78,74  
California special size cm. 185 x 215 | in. 72,83 x 84,64  
California size cm. 185 x 205 | in. 70,86 x 80,70

#### LARGE

King size cm. 195 x 205 | in. 76,77 x 80,70  
King special size cm. 195 x 215 | in. 76,77 x 84,64  
King over size cm. 200 x 200 | in. 78,74 x 78,74

	CAT. A ECOPELLE, ECONABUK FAUX LEATHER, ECONABUK	CAT. B LINO, VELLUTO, BOUCLÉ LINEN, VELVET, BOUCLÉ	CAT. C PELLE LEATHER	CAT. COM TESSUTO CLIENTE CUSTOMER'S FABRIC	RETE A DOGHE DI LEGNO WOODEN SLATTER BASE	OPTIONAL
<b>SMALL</b>						
<b>DON5301K</b> cm. L. 190 P. 210   in. W. 74,80 D. 83,46 - Kg. 65 M³ 0,25 PER RETE - FOR BED BASE: European size <b>160 x 200</b>   in. 63,00 x 78,74	2.800	2.900	3.450	2.700 Mt. L. 0,50	ACS5160K 433	-
<b>DON5302K</b> cm. L. 185 P. 215   in. W. 72,83 D. 84,65 - Kg. 80 M³ 0,30 PER RETE - FOR BED BASE: Queen size <b>155 x 205</b>   in. 61,02 x 80,70	2.800	2.900	3.450	2.700 Mt. L. 0,50	ACS5200K 637	-
<b>MEDIUM</b>						
<b>DON5331K</b> cm. L. 215 P. 210   in. W. 84,65 D. 82,67 - Kg. 75 M³ 0,28 PER RETE - FOR BED BASE: European special size <b>180 x 200</b>   in. 70,86 x 78,74	3.100	3.200	3.700	3.000 Mt. L. 0,70	ACS5180K 593	-
<b>DON5332K</b> cm. L. 215 P. 225   in. W. 84,64 D. 88,58 - Kg. 90 M³ 0,38 PER RETE - FOR BED BASE: California special size <b>185 x 215</b>   in. 72,83 x 84,64	3.100	3.200	3.700	3.000 Mt. L. 0,70	ACS5220K 696	-
<b>DON5333K</b> cm. L. 215 P. 215   in. W. 84,64 D. 84,64 - Kg. 88 M³ 0,36 PER RETE - FOR BED BASE: California size <b>185 x 205</b>   in. 70,86 x 80,70	3.100	3.200	3.700	3.000 Mt. L. 0,70	ACS5210K 653	-
<b>LARGE</b>						
<b>DON5361K</b> cm. L. 225 P. 215   in. W. 88,58 D. 84,64 - Kg. 93 M³ 0,40 PER RETE - FOR BED BASE: King size <b>195 x 205</b>   in. 76,77 x 80,70	3.300	3.400	3.900	3.200 Mt. L. 1,00	ACS5230K 669	-
<b>DON5362K</b> cm. L. 225 P. 225   in. W. 88,58 D. 88,58 - Kg. 96 M³ 0,42 PER RETE - FOR BED BASE: King special size <b>195 x 215</b>   in. 76,77 x 84,64	3.300	3.400	3.900	3.200 Mt. L. 1,00	ACS5240K 744	-
<b>DON5363K</b> cm. L. 230 P. 210   in. W. 90,55 D. 82,68 - Kg. 100 M³ 0,45 PER RETE - FOR BED BASE: King over size <b>200 x 200</b>   in. 78,74 x 78,74	3.300	3.400	3.900	3.200 Mt. L. 1,00	ACS5250K 776	-
<b>Fascia imbottita su giroletto in legno</b> Upholstered band on wooden bed surround	400	455	555	300 Mt. L. 2,00		

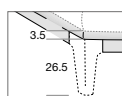

**LETTI - SENZA RETE E MATERASSO**  
**BEDS - WITHOUT BED BASE AND MATTRESS**

**LETTO SHANGHAI IMBOTTITO**

LETTO CON GIROLETTO IMBOTTITO E TESTIERA PAGLIA DI VIENNA E IMBOTTITA

**PADDED SHANGHAI BED**

BED WITH 'VIENNA STRAW' AND PADDED HEADBOARD AND UPHOLSTERED BED SURROUND

MISURE RETI DISPONIBILI - DIM. OF AVAILABLE BED BASES

**SMALL**

European size cm. 160 x 200 | in. 63,00 x 78,74  
Queen size cm. 155 x 205 | in. 61,02 x 80,70

**MEDIUM**

European special size cm. 180 x 200 | in. 70,86 x 78,74  
California special size cm. 185 x 215 | in. 72,83 x 84,64  
California size cm. 185 x 205 | in. 70,86 x 80,70

**LARGE**

King size cm. 195 x 205 | in. 76,77 x 80,70  
King special size cm. 195 x 215 | in. 76,77 x 84,64  
King over size cm. 200 x 200 | in. 78,74 x 78,74

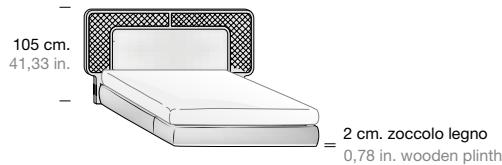

CAT. A	CAT. B	CAT. C	CAT. COM	RETE A DOGHE DI LEGNO WOODEN SLATTER BASE	OPTIONAL
ECOPELLE, ECONABUK FAUX LEATHER, ECONABUK	LINO, VELLUTO, BOUCLÉ LINEN, VELVET, BOUCLÉ	PELLE LEATHER	TESSUTO CLIENTE CUSTOMER'S FABRIC		CONTENITORE CON RETE BASCULANTE BOX STORAGE WITH TILTING NET

**SMALL**

**DON5321K**

cm. L. 190 P. 218 | in. W. 74,80 D. 85,82 - Kg. 85 M³ 0,33  
PER RETE - FOR BED BASE: European size **cm. 160 x 200** | in. 63,00 x 78,74

3.200	3.450	3.950	3.100 Mt. L. 3,00	ACS5160K 433	Kg. 66 M³ 0,40 INTERNO - INTERNAL 162 x 202 h. 16	680
-------	-------	-------	----------------------	-----------------	---	-----

**DON5322K**

cm. L. 185 P. 215 | in. W. 72,83 D. 84,65 - Kg. 80 M³ 0,30  
PER RETE - FOR BED BASE: Queen size **cm. 155 x 205** | in. 61,02 x 80,70

3.200	3.450	3.950	3.100 Mt. L. 3,00	ACS5200K 637	-	
-------	-------	-------	----------------------	-----------------	---	--

**MEDIUM**

**DON5351K**

cm. L. 210 P. 218 | in. W. 82,67 D. 85,82 - Kg. 95 M³ 0,37  
PER RETE - FOR BED BASE: European special size **cm. 180 x 200** | in. 70,86 x 78,74

3.400	3.650	4.150	3.200 Mt. L. 3,20	ACS5180K 593	Kg. 66 M³ 0,40 INTERNO - INTERNAL 182 x 202 h. 16	750
-------	-------	-------	----------------------	-----------------	---	-----

**DON5352K**

cm. L. 215 P. 225 | in. W. 84,64 D. 88,58 - Kg. 90 M³ 0,38  
PER RETE - FOR BED BASE: California special size **cm. 185 x 215** | in. 72,83 x 84,64

3.400	3.650	4.150	3.200 Mt. L. 3,20	ACS5220K 696	-	
-------	-------	-------	----------------------	-----------------	---	--

**DON5353K**

cm. L. 215 P. 215 | in. W. 84,64 D. 84,64 - Kg. 88 M³ 0,36  
PER RETE - FOR BED BASE: California size **cm. 185 x 205** | in. 70,86 x 80,70

3.400	3.650	4.150	3.200 Mt. L. 3,20	ACS5210K 653	-	
-------	-------	-------	----------------------	-----------------	---	--

**LARGE**

**DON5381K**

cm. L. 225 P. 215 | in. W. 88,58 D. 84,64 - Kg. 93 M³ 0,40  
PER RETE - FOR BED BASE: King size **cm. 195 x 205** | in. 76,77 x 80,70

3.600	3.850	4.350	3.700 Mt. L. 3,40	ACS5230K 669	-	
-------	-------	-------	----------------------	-----------------	---	--

**DON5382K**

cm. L. 225 P. 225 | in. W. 88,58 D. 88,58 - Kg. 96 M³ 0,42  
PER RETE - FOR BED BASE: King special size **cm. 195 x 215** | in. 76,77 x 84,64

3.600	3.850	4.350	3.700 Mt. L. 3,40	ACS5240K 744	-	
-------	-------	-------	----------------------	-----------------	---	--

**DON5383K**

cm. L. 230 P. 210 | in. W. 90,55 D. 82,68 - Kg. 100 M³ 0,45  
PER RETE - FOR BED BASE: King over size **cm. 200 x 200** | in. 78,74 x 78,74

3.600	3.850	4.350	3.700 Mt. L. 3,40	ACS5250K 776	-	
-------	-------	-------	----------------------	-----------------	---	--

**MAGGIORAZIONI - SURCHARGES**

Contenitore  
Container box

650

Contenitore con sollevamento orizzontale  
Container box with horizontal lifting mechanism



222

# NOTTE - NIGHT

## LETTI - SENZA RETE E MATERASSO BEDS - WITHOUT BED BASE AND MATTRESS

### LETTO BATTLO

LETTO CON GIROLETTO LEGNO E TESTIERA IN LEGNO

### BATTLO BED

BED WITH WOODEN HEADBOARD AND BED SURROUND

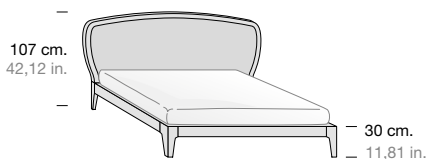

### MISURE RETI DISPONIBILI - DIM. OF AVAILABLE BED BASES

#### SMALL

European size cm. 160 x 200 | in. 63,00 x 78,74  
Queen size cm. 155 x 205 | in. 61,02 x 80,70

#### MEDIUM

European special size cm. 180 x 200 | in. 70,86 x 78,74  
California special size cm. 185 x 215 | in. 72,83 x 84,64  
California size cm. 185 x 205 | in. 70,86 x 80,70

#### LARGE

King size cm. 195 x 205 | in. 76,77 x 80,70  
King special size cm. 195 x 215 | in. 76,77 x 84,64  
King over size cm. 200 x 200 | in. 78,74 x 78,74

PREZZI PRICES	RETE A DOGHE DI LEGNO WOODEN SLATTER BASE	OPTIONAL
------------------	--	----------

### SMALL

#### DON5401K

cm. L. 198 P. 208 | in. W. 77,95 D. 81,88 - Kg. 65 M³ 0,23  
PER RETE - FOR BED BASE: European size **160 x 200** | in. 63,00 x 78,74

2.550	ACS5160K 433	-
-------	-----------------	---

#### DON5403K

cm. L. 193 P. 213 | in. W. 75,98 D. 83,86 - Kg. 80 M³ 0,30  
PER RETE - FOR BED BASE: Queen size **155 x 205** | in. 61,02 x 80,70

2.550	ACS5200K 637	-
-------	-----------------	---

### MEDIUM

#### DON5442K

cm. L. 218 P. 208 | in. W. 85,82 D. 81,88 - Kg. 75 M³ 0,26  
PER RETE - FOR BED BASE: European special size **180 x 200** | in. 70,86 x 78,74

2.750	ACS5180K 593	-
-------	-----------------	---

#### DON5443K

cm. L. 223 P. 223 | in. W. 87,80 D. 87,80 - Kg. 90 M³ 0,38  
PER RETE - FOR BED BASE: California special size **185 x 215** | in. 72,83 x 84,64

2.750	ACS5220K 696	-
-------	-----------------	---

#### DON5444K

cm. L. 223 P. 213 | in. W. 87,80 D. 83,86 - Kg. 88 M³ 0,36  
PER RETE - FOR BED BASE: California size **185 x 205** | in. 70,86 x 80,70

2.750	ACS5210K 653	-
-------	-----------------	---

### LARGE

#### DON5601K

cm. L. 233 P. 213 | in. W. 91,73 D. 83,86 - Kg. 93 M³ 0,40  
PER RETE - FOR BED BASE: King size **195 x 205** | in. 76,77 x 80,70

2.950	ACS5230K 669	-
-------	-----------------	---

#### DON5603K

cm. L. 233 P. 223 | in. W. 91,73 D. 87,80 - Kg. 96 M³ 0,42  
PER RETE - FOR BED BASE: King special size **195 x 215** | in. 76,77 x 84,64

2.950	ACS5240K 744	-
-------	-----------------	---

#### DON5604K

cm. L. 238 P. 208 | in. W. 93,70 D. 81,89 - Kg. 100 M³ 0,45  
PER RETE - FOR BED BASE: King over size **200 x 200** | in. 78,74 x 78,74

2.950	ACS5250K 776	-
-------	-----------------	---

### MAGGIORAZIONI - SURCHARGES

Fascia imbottita su giroletto in legno  
Upholstered band on wooden bed surround

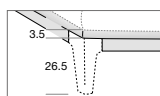

CAT. A ECOPELLE, ECONABUK FAUX LEATHER, ECONABUK	CAT. B LINO/VELLUTO/BOUCLÉ LINEN/VELVET/BOUCLÉ	CAT. C PELLE LEATHER	CAT. COM TESSUTO CLIENTE CUSTOMER'S FABRIC
400	455	555	300 Mt. L. 2,00



**LETTI - SENZA RETE E MATERASSO**  
**BEDS - WITHOUT BED BASE AND MATTRESS**

**LETTO BATTLÒ IMBOTTITO**

LETTO CON GIROLETTO IMBOTTITO E TESTIERA IN LEGNO

**PADDED BATTLÒ BED**

BED WITH WOODEN HEADBOARD AND PADDED BED SURROUND

MISURE RETI DISPONIBILI - DIM. OF AVAILABLE BED BASES

**SMALL**

European size cm. 160 x 200 | in. 63,00 x 78,74  
Queen size cm. 155 x 205 | in. 61,02 x 80,70

**MEDIUM**

European special size cm. 180 x 200 | in. 70,86 x 78,74  
California special size cm. 185 x 215 | in. 72,83 x 84,64  
California size cm. 185 x 205 | in. 70,86 x 80,70

**LARGE**

King size cm. 195 x 205 | in. 76,77 x 80,70  
King special size cm. 195 x 215 | in. 76,77 x 84,64  
King over size cm. 200 x 200 | in. 78,74 x 78,74

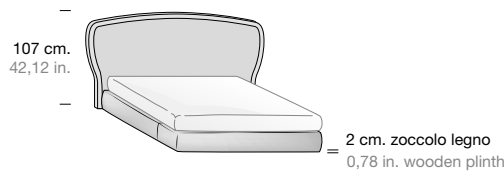

CAT. A	CAT. B	CAT. C	CAT. COM	RETE A DOGHE DI LEGNO WOODEN SLATTER BASE	OPTIONAL CONTENITORE CON RETE BASCULANTE BOX STORAGE WITH TILTING NET
ECOPELLE, ECONABUK FAUX LEATHER, ECONABUK	LINO, VELLUTO, BOUCLÉ LINEN, VELVET, BOUCLÉ	PELLE LEATHER	TESSUTO CLIENTE CUSTOMER'S FABRIC		

**SMALL**

**DON5412K**

cm. L. 198 P. 216 | in. W. 77,95 D. 85,03 - Kg. 85 M³ 0,31  
PER RETE - FOR BED BASE: European size **160 x 200** | in. 63,00 x 78,74

2.950	3.150	3.550	2.800 Mt. L. 2,50	ACS5160K 433	Kg. 66 M³ 0,40 INTERNO - INTERNAL 162 x 202 h. 16	680
-------	-------	-------	----------------------	-----------------	---	-----

**DON5413K**

cm. L. 193 P. 220 | in. W. 75,98 D. 86,61 - Kg. 80 M³ 0,30  
PER RETE - FOR BED BASE: Queen size **155 x 205** | in. 61,02 x 80,70

2.950	3.150	3.550	2.800 Mt. L. 2,50	ACS5200K 637	-	
-------	-------	-------	----------------------	-----------------	---	--

**MEDIUM**

**DON5492K**

cm. L. 218 P. 216 | in. W. 85,82 D. 85,03 - Kg. 100 M³ 0,35  
PER RETE - FOR BED BASE: European special size **180 x 200** | in. 70,86 x 78,74

3.150	3.350	3.750	3.000 Mt. L. 2,70	ACS5180K 593	Kg. 66 M³ 0,40 INTERNO - INTERNAL 182 x 202 h. 16	750
-------	-------	-------	----------------------	-----------------	---	-----

**DON5493K**

cm. L. 223 P. 228 | in. W. 87,80 D. 89,76 - Kg. 90 M³ 0,38  
PER RETE - FOR BED BASE: California special size **185 x 215** | in. 72,83 x 84,64

3.150	3.350	3.750	3.000 Mt. L. 2,70	ACS5220K 696	-	
-------	-------	-------	----------------------	-----------------	---	--

**DON5494K**

cm. L. 223 P. 221 | in. W. 87,80 D. 87,01 - Kg. 88 M³ 0,36  
PER RETE - FOR BED BASE: California size **185 x 205** | in. 70,86 x 80,70

3.150	3.350	3.750	3.000 Mt. L. 2,70	ACS5210K 653	-	
-------	-------	-------	----------------------	-----------------	---	--

**LARGE**

**DON5611K**

cm. L. 233 P. 221 | in. W. 91,73 D. 87,01 - Kg. 93 M³ 0,40  
PER RETE - FOR BED BASE: King size **195 x 205** | in. 76,77 x 80,70

3.350	3.550	3.950	3.200 Mt. L. 2,90	ACS5230K 669	-	
-------	-------	-------	----------------------	-----------------	---	--

**DON5613K**

cm. L. 233 P. 230 | in. W. 91,73 D. 90,55 - Kg. 96 M³ 0,42  
PER RETE - FOR BED BASE: King special size **195 x 215** | in. 76,77 x 84,64

3.350	3.550	3.950	3.200 Mt. L. 2,90	ACS5240K 744	-	
-------	-------	-------	----------------------	-----------------	---	--

**DON5614K**

cm. L. 238 P. 217 | in. W. 93,70 D. 85,43 - Kg. 100 M³ 0,45  
PER RETE - FOR BED BASE: King over size **200 x 200** | in. 78,74 x 78,74

3.350	3.550	3.950	3.200 Mt. L. 2,90	ACS5250K 776	-	
-------	-------	-------	----------------------	-----------------	---	--

**MAGGIORAZIONI - SURCHARGES**

Contenitore  
Container box

650

Contenitore con sollevamento orizzontale  
Container box with horizontal lifting mechanism

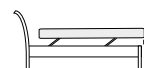

222

# NOTTE - NIGHT

## LETTI - SENZA RETE E MATERASSO BEDS - WITHOUT BED BASE AND MATTRESS

### LETTO BATTLO' IMBOTTITO

LETTO CON GIROLETTO LEGNO E TESTIERA IMBOTTITA

### PADDED BATTLO' BED

BED WITH PADDED HEADBOARD AND WOODEN BED SURROUND

MISURE RETI DISPONIBILI - DIM. OF AVAILABLE BED BASES

#### SMALL

European size cm. 160 x 200 | in. 63,00 x 78,74  
Queen size cm. 155 x 205 | in. 61,02 x 80,70

#### MEDIUM

European special size cm. 180 x 200 | in. 70,86 x 78,74  
California special size cm. 185 x 215 | in. 72,83 x 84,64  
California size cm. 185 x 205 | in. 70,86 x 80,70

#### LARGE

King size cm. 195 x 205 | in. 76,77 x 80,70  
King special size cm. 195 x 215 | in. 76,77 x 84,64  
King over size cm. 200 x 200 | in. 78,74 x 78,74



CAT. A	CAT. B	CAT. C	CAT. COM	OPTIONAL
ECOPELLE, ECONABUK FAUX LEATHER, ECONABUK	LINO, VELLUTO, BOUCLE LINEN, VELVET, BOUCLE	PELLE LEATHER	TESSUTO CLIENTE CUSTOMER'S FABRIC	RETE A DOGHE DI LEGNO WOODEN SLATTER BASE

### SMALL

#### DON5411K

cm. L. 198 P. 208 | in. W. 77,95 D. 81,88 - Kg. 65 M³ 0,23  
PER RETE - FOR BED BASE: European size **160 x 200** | in. 63,00 x 78,74

2.450

2.650

2.850

2.350  
Mt. L. 2,00

ACS5160K  
433

-

#### DON5413K

cm. L. 193 P. 213 | in. W. 75,98 D. 83,86 - Kg. 80 M³ 0,30  
PER RETE - FOR BED BASE: Queen size **155 x 205** | in. 61,02 x 80,70

2.450

2.650

2.850

2.350  
Mt. L. 2,00

ACS5200K  
637

-

### MEDIUM

#### DON5481K

cm. L. 218 P. 208 | in. W. 85,82 D. 81,88 - Kg. 75 M³ 0,26  
PER RETE - FOR BED BASE: European special size **180 x 200** | in. 70,86 x 78,74

2.650

2.850

3.050

2.550  
Mt. L. 2,30

ACS5180K  
593

-

#### DON5483K

cm. L. 223 P. 223 | in. W. 87,80 D. 87,80 - Kg. 90 M³ 0,38  
PER RETE - FOR BED BASE: California special size **185 x 215** | in. 72,83 x 84,64

2.650

2.850

3.050

2.550  
Mt. L. 2,30

ACS5220K  
696

-

#### DON5484K

cm. L. 223 P. 213 | in. W. 87,80 D. 83,86 - Kg. 88 M³ 0,36  
PER RETE - FOR BED BASE: California size **185 x 205** | in. 70,86 x 80,70

2.650

2.850

3.050

2.550  
Mt. L. 2,30

ACS5210K  
653

-

### LARGE

#### DON5621K

cm. L. 233 P. 213 | in. W. 91,73 D. 83,86 - Kg. 93 M³ 0,40  
PER RETE - FOR BED BASE: King size **195 x 205** | in. 76,77 x 80,70

2.850

3.050

3.250

2.750  
Mt. L. 2,50

ACS5230K  
669

-

#### DON5623K

cm. L. 233 P. 223 | in. W. 91,73 D. 87,80 - Kg. 96 M³ 0,42  
PER RETE - FOR BED BASE: King special size **195 x 215** | in. 76,77 x 84,64

2.850

3.050

3.250

2.750  
Mt. L. 2,50

ACS5240K  
744

-

#### DON5624K

cm. L. 238 P. 208 | in. W. 93,70 D. 81,89 - Kg. 100 M³ 0,45  
PER RETE - FOR BED BASE: King over size **200 x 200** | in. 78,74 x 78,74

2.850

3.050

3.250

2.750  
Mt. L. 2,50

ACS5250K  
776

-

### MAGGIORAZIONI - SURCHARGES

Fascia imbottita su giroletto in legno  
Upholstered band on wooden bed surround

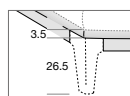

400

455

555

300  
Mt. L. 2,00

**LETTI - SENZA RETE E MATERASSO**  
**BEDS - WITHOUT BED BASE AND MATTRESS**

**LETTO BATTLO' IMBOTTITO**

LETTO CON GIROLETTO IMBOTTITO E TESTIERA IMBOTTITA

**PADDED BATTLO' BED**

BED WITH PADDED HEADBOARD AND BED SURROUND



MISURE RETI DISPONIBILI - DIM. OF AVAILABLE BED BASES

**SMALL**

European size cm. 160 x 200 | in. 63,00 x 78,74  
Queen size cm. 155 x 205 | in. 61,02 x 80,70

**MEDIUM**

European special size cm. 180 x 200 | in. 70,86 x 78,74  
California special size cm. 185 x 215 | in. 72,83 x 84,64  
California size cm. 185 x 205 | in. 70,86 x 80,70

**LARGE**

King size cm. 195 x 205 | in. 76,77 x 80,70  
King special size cm. 195 x 215 | in. 76,77 x 84,64  
King over size cm. 200 x 200 | in. 78,74 x 78,74

	CAT. A ECOPELLE, ECONABUK FAUX LEATHER, ECONABUK	CAT. B LINO, VELLUTO, BOUCLE LINEN, VELVET, BOUCLE	CAT. C PELLE LEATHER	CAT. COM TESSUTO CLIENTE CUSTOMER'S FABRIC	RETE A DOGHE DI LEGNO WOODEN SLATTER BASE	OPTIONAL CONTENITORE CON RETE BASCULANTE BOX STORAGE WITH TILTING NET
--	--	--	----------------------------	--	--	---

**SMALL**

**DON5421K**

cm. L. 198 P. 216 | in. W. 77,95 D. 85,03 - Kg. 85 M³ 0,31  
PER RETE - FOR BED BASE: European size **160 x 200** | in. 63,00 x 78,74

3.450	3.750	4.100	3.050 Mt. L. 4,50	ACS5160K 433	Kg. 66 M³ 0,40 INTERNO - INTERNAL 162 x 202 h. 16	680
-------	-------	-------	----------------------	-----------------	---	-----

**DON5423K**

cm. L. 193 P. 220 | in. W. 75,98 D. 86,61 - Kg. 80 M³ 0,30  
PER RETE - FOR BED BASE: Queen size **155 x 205** | in. 61,02 x 80,70

3.450	3.750	4.100	3.050 Mt. L. 4,50	ACS5200K 637	-	
-------	-------	-------	----------------------	-----------------	---	--

**MEDIUM**

**DON5491K**

cm. L. 218 P. 216 | in. W. 85,82 D. 85,03 - Kg. 100 M³ 0,35  
PER RETE - FOR BED BASE: European special size **180 x 200** | in. 70,86 x 78,74

3.650	3.950	4.300	3.250 Mt. L. 5,00	ACS5180K 593	Kg. 66 M³ 0,40 INTERNO - INTERNAL 182 x 202 h. 16	750
-------	-------	-------	----------------------	-----------------	---	-----

**DON5493K**

cm. L. 223 P. 228 | in. W. 87,80 D. 89,76 - Kg. 90 M³ 0,38  
PER RETE - FOR BED BASE: California special size **185 x 215** | in. 72,83 x 84,64

3.650	3.950	4.300	3.250 Mt. L. 5,00	ACS5220K 696	-	
-------	-------	-------	----------------------	-----------------	---	--

**DON5494K**

cm. L. 223 P. 221 | in. W. 87,80 D. 87,01 - Kg. 88 M³ 0,36  
PER RETE - FOR BED BASE: California size **185 x 205** | in. 70,86 x 80,70

3.650	3.950	4.300	3.250 Mt. L. 5,00	ACS5210K 653	-	
-------	-------	-------	----------------------	-----------------	---	--

**LARGE**

**DON5631K**

cm. L. 233 P. 221 | in. W. 91,73 D. 87,01 - Kg. 93 M³ 0,40  
PER RETE - FOR BED BASE: King size **195 x 205** | in. 76,77 x 80,70

3.850	4.150	4.500	3.450 Mt. L. 5,20	ACS5230K 669	-	
-------	-------	-------	----------------------	-----------------	---	--

**DON5633K**

cm. L. 233 P. 230 | in. W. 91,73 D. 90,55 - Kg. 96 M³ 0,42  
PER RETE - FOR BED BASE: King special size **195 x 215** | in. 76,77 x 84,64

3.850	4.150	4.500	3.450 Mt. L. 5,20	ACS5240K 744	-	
-------	-------	-------	----------------------	-----------------	---	--

**DON5634K**

cm. L. 238 P. 217 | in. W. 93,70 D. 85,43 - Kg. 100 M³ 0,45  
PER RETE - FOR BED BASE: King over size **200 x 200** | in. 78,74 x 78,74

3.850	4.150	4.500	3.450 Mt. L. 5,20	ACS5250K 776	-	
-------	-------	-------	----------------------	-----------------	---	--

**MAGGIORAZIONI - SURCHARGES**

Contenitore  
Container box

650
-----

Contenitore con sollevamento orizzontale  
Container box with horizontal lifting mechanism

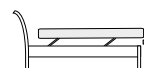

222
-----

# NOTTE - NIGHT

## LETTI - SENZA RETE E MATERASSO BEDS - WITHOUT BED BASE AND MATTRESS

### LETTO BATTLO' IMBOTTITO

LETTO CON GIROLETTO LEGNO E TESTIERA IMBOTTITA A DOGHE

### PADDED BATTLO' BED

BED WITH SLATTED PADDED HEADBOARD AND WOODEN BED SURROUND

MISURE RETI DISPONIBILI - DIM. OF AVAILABLE BED BASES

#### SMALL

European size cm. 160 x 200 | in. 63,00 x 78,74  
Queen size cm. 155 x 205 | in. 61,02 x 80,70

#### MEDIUM

European special size cm. 180 x 200 | in. 70,86 x 78,74  
California special size cm. 185 x 215 | in. 72,83 x 84,64  
California size cm. 185 x 205 | in. 70,86 x 80,70

#### LARGE

King size cm. 195 x 205 | in. 76,77 x 80,70  
King special size cm. 195 x 215 | in. 76,77 x 84,64  
King over size cm. 200 x 200 | in. 78,74 x 78,74



CAT. A	CAT. B	CAT. C	CAT. COM	OPTIONAL
ECOPELLE, ECONABUK FAUX LEATHER, ECONABUK	LINO, VELLUTO, BOUCLE LINEN, VELVET, BOUCLE	PELLE LEATHER	TESSUTO CLIENTE CUSTOMER'S FABRIC	RETE A DOGHE DI LEGNO WOODEN SLATTER BASE

### SMALL

#### DON5431K

cm. L. 198 P. 208 | in. W. 77,95 D. 81,88 - Kg. 65 M³ 0,23  
PER RETE - FOR BED BASE: European size **160 x 200** | in. 63,00 x 78,74

2.950

3.150

3.350

2.850  
Mt. L. 2,50

ACS5160K  
433

-

#### DON5433K

cm. L. 193 P. 213 | in. W. 75,98 D. 83,86 - Kg. 80 M³ 0,30  
PER RETE - FOR BED BASE: Queen size **155 x 205** | in. 61,02 x 80,70

2.950

3.150

3.350

2.850  
Mt. L. 2,50

ACS5200K  
637

-

### MEDIUM

#### DON5461K

cm. L. 218 P. 208 | in. W. 85,82 D. 81,88 - Kg. 75 M³ 0,26  
PER RETE - FOR BED BASE: European special size **180 x 200** | in. 70,86 x 78,74

3.150

3.350

3.650

3.050  
Mt. L. 2,80

ACS5180K  
593

-

#### DON5463K

cm. L. 223 P. 223 | in. W. 87,80 D. 87,80 - Kg. 90 M³ 0,38  
PER RETE - FOR BED BASE: California special size **185 x 215** | in. 72,83 x 84,64

3.150

3.350

3.650

3.050  
Mt. L. 2,80

ACS5220K  
696

-

#### DON5464K

cm. L. 223 P. 213 | in. W. 87,80 D. 83,86 - Kg. 88 M³ 0,36  
PER RETE - FOR BED BASE: California size **185 x 205** | in. 70,86 x 80,70

3.150

3.350

3.650

3.050  
Mt. L. 2,80

ACS5210K  
653

-

### LARGE

#### DON5641K

cm. L. 233 P. 213 | in. W. 91,73 D. 83,86 - Kg. 93 M³ 0,40  
PER RETE - FOR BED BASE: King size **195 x 205** | in. 76,77 x 80,70

3.350

3.650

3.950

3.250  
Mt. L. 3,00

ACS5230K  
669

-

#### DON5643K

cm. L. 233 P. 223 | in. W. 91,73 D. 87,80 - Kg. 96 M³ 0,42  
PER RETE - FOR BED BASE: King special size **195 x 215** | in. 76,77 x 84,64

3.350

3.650

3.950

3.250  
Mt. L. 3,00

ACS5240K  
744

-

#### DON5644K

cm. L. 238 P. 208 | in. W. 93,70 D. 81,89 - Kg. 100 M³ 0,45  
PER RETE - FOR BED BASE: King over size **200 x 200** | in. 78,74 x 78,74

3.350

3.650

3.950

3.250  
Mt. L. 3,00

ACS5250K  
776

-

### MAGGIORAZIONI - SURCHARGES

Fascia imbottita su giroletto in legno  
Upholstered band on wooden bed surround

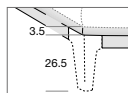

400

455

555

300  
Mt. L. 2,00

**LETTI - SENZA RETE E MATERASSO**  
**BEDS - WITHOUT BED BASE AND MATTRESS**

**LETTO BATTLO' IMBOTTITO**

LETTO CON GIROLETTO IMBOTTITO E TESTIERA IMBOTTITA A DOGHE

**PADDED BATTLO' BED**

BED WITH SLATTED PADDED HEADBOARD AND BED SURROUND

MISURE RETI DISPONIBILI - DIM. OF AVAILABLE BED BASES

**SMALL**

European size cm. 160 x 200 | in. 63,00 x 78,74  
Queen size cm. 155 x 205 | in. 61,02 x 80,70

**MEDIUM**

European special size cm. 180 x 200 | in. 70,86 x 78,74  
California special size cm. 185 x 215 | in. 72,83 x 84,64  
California size cm. 185 x 205 | in. 70,86 x 80,70

**LARGE**

King size cm. 195 x 205 | in. 76,77 x 80,70  
King special size cm. 195 x 215 | in. 76,77 x 84,64  
King over size cm. 200 x 200 | in. 78,74 x 78,74

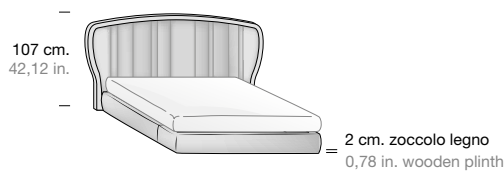

CAT. A	CAT. B	CAT. C	CAT. COM	RETE A DOGHE DI LEGNO WOODEN SLATTER BASE	OPTIONAL
ECOPELLE, ECONABUK FAUX LEATHER, ECONABUK	LINO, VELLUTO, BOUCLÉ LINEN, VELVET, BOUCLÉ	PELLE LEATHER	TESSUTO CLIENTE CUSTOMER'S FABRIC		CONTENITORE CON RETE BASCULANTE BOX STORAGE WITH TILTING NET

**SMALL**

**DON5441K**

cm. L. 198 P. 216 | in. W. 77,95 D. 85,03 - Kg. 85 M³ 0,31  
PER RETE - FOR BED BASE: European size **160 x 200** | in. 63,00 x 78,74

3.750

3.950

4.400

3.350

Mt. L. 5,00

ACS5160K

433

Kg. 66 M³ 0,40  
INTERNO - INTERNAL  
162 x 202 h. 16

680

**DON5443K**

cm. L. 193 P. 220 | in. W. 75,98 D. 86,61 - Kg. 80 M³ 0,30  
PER RETE - FOR BED BASE: Queen size **155 x 205** | in. 61,02 x 80,70

3.750

3.950

4.400

3.350

Mt. L. 5,00

ACS5200K

637

-

**MEDIUM**

**DON5471K**

cm. L. 218 P. 216 | in. W. 85,82 D. 85,03 - Kg. 100 M³ 0,35  
PER RETE - FOR BED BASE: European special size **180 x 200** | in. 70,86 x 78,74

3.950

4.150

4.600

3.550

Mt. L. 5,30

ACS5180K

593

Kg. 66 M³ 0,40  
INTERNO - INTERNAL  
182 x 202 h. 16

750

**DON5473K**

cm. L. 223 P. 228 | in. W. 87,80 D. 89,76 - Kg. 90 M³ 0,38  
PER RETE - FOR BED BASE: California special size **185 x 215** | in. 72,83 x 84,64

3.950

4.150

4.600

3.550

Mt. L. 5,30

ACS5220K

696

-

**DON5474K**

cm. L. 223 P. 221 | in. W. 87,80 D. 87,01 - Kg. 88 M³ 0,36  
PER RETE - FOR BED BASE: California size **185 x 205** | in. 70,86 x 80,70

3.950

4.150

4.600

3.550

Mt. L. 5,30

ACS5210K

653

-

**LARGE**

**DON5651K**

cm. L. 233 P. 221 | in. W. 91,73 D. 87,01 - Kg. 93 M³ 0,40  
PER RETE - FOR BED BASE: King size **195 x 205** | in. 76,77 x 80,70

4.150

4.350

4.800

3.750

Mt. L. 5,50

ACS5230K

669

-

**DON5653K**

cm. L. 233 P. 230 | in. W. 91,73 D. 90,55 - Kg. 96 M³ 0,42  
PER RETE - FOR BED BASE: King special size **195 x 215** | in. 76,77 x 84,64

4.150

4.350

4.800

3.750

Mt. L. 5,50

ACS5240K

744

-

**DON5654K**

cm. L. 238 P. 217 | in. W. 93,70 D. 85,43 - Kg. 100 M³ 0,45  
PER RETE - FOR BED BASE: King over size **200 x 200** | in. 78,74 x 78,74

4.150

4.350

4.800

3.750

Mt. L. 5,50

ACS5250K

776

-

**MAGGIORAZIONI - SURCHARGES**

Contenitore  
Container box

650

Contenitore con sollevamento orizzontale  
Container box with horizontal lifting mechanism

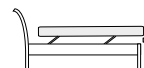

222

# NOTTE - NIGHT

## LETTI - SENZA RETE E MATERASSO BEDS - WITHOUT BED BASE AND MATTRESS

### LETTO RAINBOW BARRÉ IMBOTTITO H. 115

LETTO CON GIROLETTO LEGNO E TESTIERA IMBOTTITA CON 2 CUSCINI CUCITURA BARRÉ

### PADDED BARRÉ RAINBOW BED H. 115

BED WITH UPHOLSTERED HEADBOARD WITH 2 CUSHIONS WITH BARRÉ SEAM AND WOODEN BED SURROUND

MISURE RETI DISPONIBILI - DIM. OF AVAILABLE BED BASES

#### SMALL

European size cm. 160 x 200 | in. 63,00 x 78,74  
Queen size cm. 155 x 205 | in. 61,02 x 80,70

#### MEDIUM

European special size cm. 180 x 200 | in. 70,86 x 78,74  
California special size cm. 185 x 215 | in. 72,83 x 84,64  
California size cm. 185 x 205 | in. 70,86 x 80,70

#### LARGE

King size cm. 195 x 205 | in. 76,77 x 80,70  
King special size cm. 195 x 215 | in. 76,77 x 84,64  
King over size cm. 200 x 200 | in. 78,74 x 78,74

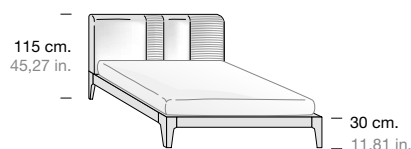

	CAT. A ECOPELLE, ECONABUK FAUX LEATHER, ECONABUK	CAT. B LINO, VELLUTO, BOUCLÉ LINEN, VELVET, BOUCLÉ	CAT. C PELLE LEATHER	CAT. COM TESSUTO CLIENTE CUSTOMER'S FABRIC	RETE A DOGHE DI LEGNO WOODEN SLATTER BASE	OPTIONAL
--	--	--	----------------------------	--	--	----------

### SMALL

#### DON5902K

cm. L. 170 P. 217 | in. W. 66,92 D. 85,43 - Kg. 75 M³ 0,40  
PER RETE - FOR BED BASE: European size **cm. 160 x 200** | in. 63,00 x 78,74

3.350

3.450

3.950

3.200  
Mt. L. 6,00

ACS5160K  
433

-

#### DON5903K

cm. L. 165 P. 217 | in. W. 64,96 D. 85,43 - Kg. 80 M³ 0,30  
PER RETE - FOR BED BASE: Queen size **cm. 155 x 205** | in. 61,02 x 80,70

3.350

3.450

3.950

3.200  
Mt. L. 6,00

ACS5200K  
637

-

### MEDIUM

#### DON5932K

cm. L. 190 P. 217 | in. W. 74,80 D. 85,43 - Kg. 85 M³ 0,44  
PER RETE - FOR BED BASE: European special size **cm. 180 x 200** | in. 70,86 x 78,74

3.550

3.650

4.150

3.400  
Mt. L. 6,30

ACS5180K  
593

-

#### DON5933K

cm. L. 195 P. 227 | in. W. 76,77 D. 89,37 - Kg. 90 M³ 0,38  
PER RETE - FOR BED BASE: California special size **cm. 185 x 215** | in. 72,83 x 84,64

3.550

3.650

4.150

3.400  
Mt. L. 6,30

ACS5220K  
696

-

#### DON5934K

cm. L. 195 P. 217 | in. W. 76,77 D. 85,43 - Kg. 88 M³ 0,36  
PER RETE - FOR BED BASE: California size **cm. 185 x 205** | in. 70,86 x 80,70

3.550

3.650

4.150

3.400  
Mt. L. 6,30

ACS5210K  
653

-

### LARGE

#### DON5962K

cm. L. 205 P. 217 | in. W. 80,71 D. 85,43 - Kg. 93 M³ 0,40  
PER RETE - FOR BED BASE: King size **cm. 195 x 205** | in. 76,77 x 80,70

3.750

3.850

4.350

3.600  
Mt. L. 6,50

ACS5230K  
669

-

#### DON5963K

cm. L. 205 P. 227 | in. W. 80,71 D. 89,37 - Kg. 96 M³ 0,42  
PER RETE - FOR BED BASE: King special size **cm. 195 x 215** | in. 76,77 x 84,64

3.750

3.850

4.350

3.600  
Mt. L. 6,50

ACS5240K  
744

-

#### DON5964K

cm. L. 210 P. 217 | in. W. 82,68 D. 85,43 - Kg. 100 M³ 0,45  
PER RETE - FOR BED BASE: King over size **cm. 200 x 200** | in. 78,74 x 78,74

3.750

3.850

4.350

3.600  
Mt. L. 6,50

ACS5250K  
776

-

### MAGGIORAZIONI - SURCHARGES

Cuscini Multicolor  
Multicolor cushions

+ 5%

Fascia imbottita su giroletto in legno  
Upholstered band on wooden bed surround

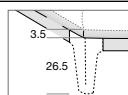

400

455

555

300  
Mt. L. 2,00

**LETTI - SENZA RETE E MATERASSO**  
**BEDS - WITHOUT BED BASE AND MATTRESS**

**LETTO RAINBOW BARRÉ IMBOTTITO H. 115**

CON GIROLETTO IMBOTTITO E TESTIERA IMBOTTITA CON 2 CUSCINI CUCITURA BARRÉ

**PADDED BARRÉ RAINBOW BED H. 115**

BED WITH UPHOLSTERED HEADBOARD WITH 2 CUSHIONS WITH BARRÉ SEAM AND PADDED BED SURROUND

MISURE RETI DISPONIBILI - DIM. OF AVAILABLE BED BASES

**SMALL**

European size cm. 160 x 200 | in. 63,00 x 78,74  
Queen size cm. 155 x 205 | in. 61,02 x 80,70

**MEDIUM**

European special size cm. 180 x 200 | in. 70,86 x 78,74  
California special size cm. 185 x 215 | in. 72,83 x 84,64  
California size cm. 185 x 205 | in. 70,86 x 80,70

**LARGE**

King size cm. 195 x 205 | in. 76,77 x 80,70  
King special size cm. 195 x 215 | in. 76,77 x 84,64  
King over size cm. 200 x 200 | in. 78,74 x 78,74

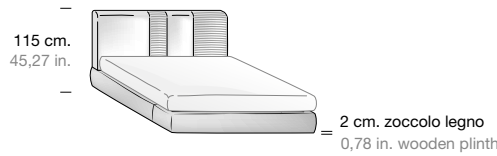

CAT. A	CAT. B	CAT. C	CAT. COM	RETE A DOGHE DI LEGNO WOODEN SLATTER BASE	OPTIONAL
ECOPELLE, ECONABUK FAUX LEATHER, ECONABUK	LINO, VELLUTO, BOUCLÉ LINEN, VELVET, BOUCLÉ	PELLE LEATHER	TESSUTO CLIENTE CUSTOMER'S FABRIC		CONTENITORE CON RETE BASCULANTE BOX STORAGE WITH TILTING NET

**SMALL**

**DON5922K**

cm. L. 170 P. 225 | in. W. 66,92 D. 88,58 - Kg. 95 M³ 0,48  
PER RETE - FOR BED BASE: European size **160 x 200** | in. 63,00 x 78,74

3.550	3.750	4.250	3.300 Mt. L. 10,10	ACS5160K 433	Kg. 66 M³ 0,40 INTERNO - INTERNAL 162 x 202 h. 16	680
-------	-------	-------	-----------------------	-----------------	---	-----

**DON5923K**

cm. L. 165 P. 217 | in. W. 64,96 D. 85,43 - Kg. 80 M³ 0,30  
PER RETE - FOR BED BASE: Queen size **155 x 205** | in. 61,02 x 80,70

3.550	3.750	4.250	3.300 Mt. L. 10,10	ACS5200K 637	-	
-------	-------	-------	-----------------------	-----------------	---	--

**MEDIUM**

**DON5952K**

cm. L. 190 P. 225 | in. W. 74,80 D. 88,58 - Kg. 105 M³ 0,42  
PER RETE - FOR BED BASE: European special size **180 x 200** | in. 70,86 x 78,74

3.750	3.950	4.450	3.750 Mt. L. 10,50	ACS5180K 593	Kg. 66 M³ 0,40 INTERNO - INTERNAL 182 x 202 h. 16	750
-------	-------	-------	-----------------------	-----------------	---	-----

**DON5953K**

cm. L. 195 P. 227 | in. W. 76,77 D. 89,37 - Kg. 90 M³ 0,38  
PER RETE - FOR BED BASE: California special size **185 x 215** | in. 72,83 x 84,64

3.750	3.950	4.450	3.750 Mt. L. 10,50	ACS5220K 696	-	
-------	-------	-------	-----------------------	-----------------	---	--

**DON5954K**

cm. L. 195 P. 217 | in. W. 76,77 D. 85,43 - Kg. 88 M³ 0,36  
PER RETE - FOR BED BASE: California size **185 x 205** | in. 70,86 x 80,70

3.750	3.950	4.450	3.750 Mt. L. 10,50	ACS5210K 653	-	
-------	-------	-------	-----------------------	-----------------	---	--

**LARGE**

**DON5982K**

cm. L. 205 P. 217 | in. W. 80,71 D. 85,43 - Kg. 93 M³ 0,40  
PER RETE - FOR BED BASE: King size **195 x 205** | in. 76,77 x 80,70

3.950	4.150	4.650	3.950 Mt. L. 10,90	ACS5230K 669	-	
-------	-------	-------	-----------------------	-----------------	---	--

**DON5983K**

cm. L. 205 P. 227 | in. W. 80,71 D. 89,37 - Kg. 96 M³ 0,42  
PER RETE - FOR BED BASE: King special size **195 x 215** | in. 76,77 x 84,64

3.950	4.150	4.650	3.950 Mt. L. 10,90	ACS5240K 744	-	
-------	-------	-------	-----------------------	-----------------	---	--

**DON5984K**

cm. L. 210 P. 217 | in. W. 82,68 D. 85,43 - Kg. 100 M³ 0,45  
PER RETE - FOR BED BASE: King over size **200 x 200** | in. 78,74 x 78,74

3.950	4.150	4.650	3.950 Mt. L. 10,90	ACS5250K 776	-	
-------	-------	-------	-----------------------	-----------------	---	--

**MAGGIORAZIONI - SURCHARGES**

Cuscini Multicolor  
Multicolor cushions

+ 5%

Contenitore  
Container box

650

Contenitore con sollevamento orizzontale  
Container box with horizontal lifting mechanism

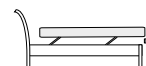

222

# NOTTE - NIGHT

## ARMADI SCORREVOLI SLIDING DOOR WARDROBES

### DOMINO 2 SPECCHI DOMINO 2 MIRRORS

2 ANTE SCORREVOLI CON 2 SPECCHI VERTICALI  
SLIDING DOORS WITH 2 VERTICAL MIRRORS

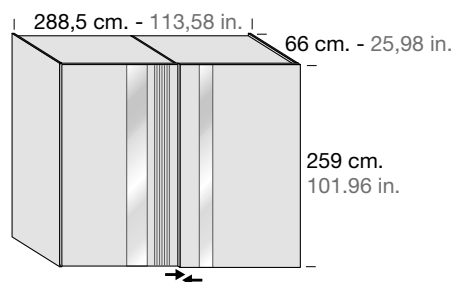

**ATTREZZATURA INTERNA:**  
2 RIPIANI 4 TUBI APPENDIABILI

**INTERIOR FITTINGS:**  
2 SHELVES, 4 CLOTHES HANGING RAILS

MAGG. FIANCHI ESTERNI IN NOCE  
CANALETTO OBBLIGATORIO PER  
FINITURA OLIO, CONSIGLIATO PER  
FINITURA HAVANA E ORIGINE  
SURCH. FOR EXTERNAL SIDES IN  
CANALETTO WALNUT, COMPULSORY  
FOR OLIO FINISH, RECOMMENDED FOR  
HAVANA AND ORIGINE FINISH + 321

DOGA LEGNO LISCIA  
SPECIFICARE SE SPECCHI ARGENTO, BRONZO O FUMÉ  
PLAIN WOODEN SLAT  
SPECIFY MIRRORS COLOR: SILVER, BRONZE OR SMOKED

DOGA LEGNO LISCIA	OPTIONAL			
DON8006K	ACS3100K L. 140 H. 56	DOGA RIGHE RIBBED SLAT	DOGA QUADRO LEGNO WOODEN SQUARE SLAT	ANTA SPORGENTE A SX FOR LH PROTRUDING DOOR
4.800	+ 470	+ 297	+ 347	+ 5 %
mc 1,45 - Kg 130	mc 0,44 - Kg 54			

### DOMINO 3 SPECCHI DOMINO 3 MIRRORS

2 ANTE SCORREVOLI CON 3 SPECCHI VERTICALI  
SLIDING DOORS WITH 3 VERTICAL MIRRORS

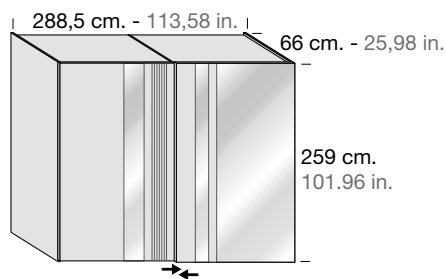

**ATTREZZATURA INTERNA:**  
2 RIPIANI 4 TUBI APPENDIABILI

**INTERIOR FITTINGS:**  
2 SHELVES, 4 CLOTHES HANGING RAILS

MAGG. FIANCHI ESTERNI IN NOCE  
CANALETTO OBBLIGATORIO PER  
FINITURA OLIO, CONSIGLIATO PER  
FINITURA HAVANA E ORIGINE  
SURCH. FOR EXTERNAL SIDES IN  
CANALETTO WALNUT, COMPULSORY  
FOR OLIO FINISH, RECOMMENDED FOR  
HAVANA AND ORIGINE FINISH + 321

DOGA LEGNO LISCIA  
SPECIFICARE SE SPECCHI ARGENTO, BRONZO O FUMÉ  
PLAIN WOODEN SLAT  
SPECIFY MIRRORS COLOR: SILVER, BRONZE OR SMOKED

DOGA LEGNO LISCIA	OPTIONAL			
DON8026K	ACS3100K L. 140 H. 56	DOGA RIGHE RIBBED SLAT	DOGA QUADRO LEGNO WOODEN SQUARE SLAT	ANTA SPORGENTE A SX FOR LH PROTRUDING DOOR
4.950	+ 470	+ 297	+ 347	+ 5 %
mc 1,45 - Kg 130	mc 0,44 - Kg 54			

**ATTREZZATURA INTERNA  
DECORATIVO COLOR  
OLMO SBIANCATO**  
INTERIOR FITTINGS  
BLEACHED ELM  
DECORATIVE COLOR

DIVISORIO INTERNO SP. 2.5  
INTERNAL PARTITIONS TH. 2.5

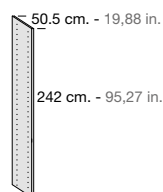

ACS1022C

415

mc 0,10 - Kg 24

DIVISORIO INTERNO SP. 2.5  
INTERNAL PARTITIONS TH. 2.5

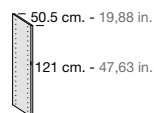

ACS1021C

222

mc 0,05 - Kg 10

KIT 2 LUCI LED IN ALLUMINIO  
VERTICALI H. 240  
KIT 2 ALUMINUM VERTICAL LED  
LIGHTS



ACS1080K

637

CON SENSORE E TRASFORMATORE (1 DX E 1 SX)  
WITH SENSOR AND TRANSFORMER (1 RH AND 1 LH)

KIT DI 2 DEPURATORI  
D'ARIA CON SISTEMA  
AIRLIGHTPRO UV-A  
KIT OF 2 PURIFIERS  
AIR WITH SYSTEM  
AIRLIGHTPRO UV-A



ACS1190K

656

PER RICAMBI FILTRI  
RIVOLGERSI A:  
FOR FILTER SPARE PARTS  
CONTACT:  
INFO@METALARREDO.IT



STRUTTURA INTERNA DECORATIVO COLOR OLMO SBIANCATO ED ESTERNO NOCE TANGANIKA  
STRUCTURE INSIDE IN BLEACHED ELM DECORATIVE COLOR AND OUTSIDE IN TANGANIKA WALNUT

## HOLA ANTE LEGNO HOLA WOODEN DOORS

2 SLIDING DOORS WITH DECORATIVE WOODEN BAND

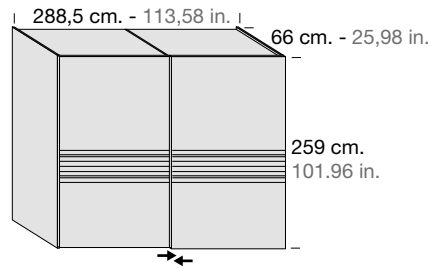

**ATTREZZATURA INTERNA:  
2 RIPIANI 4 TUBI APPENDIABITI**

**INTERIOR FITTINGS:  
2 SHELVES, 4 CLOTHES HANGING RAILS**

MAGG. FIANCHI ESTERNI IN NOCE  
CANALETTO OBBLIGATORIO PER  
FINITURA OLIO, CONSIGLIATO PER  
FINITURA HAVANA E ORIGINE + 321  
SURCH. FOR EXTERNAL SIDES IN  
CANALETTO WALNUT, COMPULSORY  
FOR OLIO FINISH, RECOMMENDED FOR  
HAVANA AND ORIGINE FINISH

CANALETTO

SHN8011K	OPTIONAL		
ACS3100K L. 140 H. 56	FASCIA BAND	ANTA SPORGENTE A SX FOR LH PROTRUDING DOOR	
	BICOLORE BICOLOR		
<b>4.950</b>	<b>+ 470</b>	<b>+ 5%</b>	<b>+ 5%</b>
mc 1,45 - Kg 130	mc 0,44 - Kg 54		

## HOLA 1 ANTA LEGNO, 1 ANTA SPECCHIO HOLA 1 WOODEN DOOR, 1 MIRROR DOOR

2 ANTE SCORREVOLI CON FASCIA DECORATIVA IN LEGNO  
2 SLIDING DOORS WITH DECORATIVE WOODEN BAND

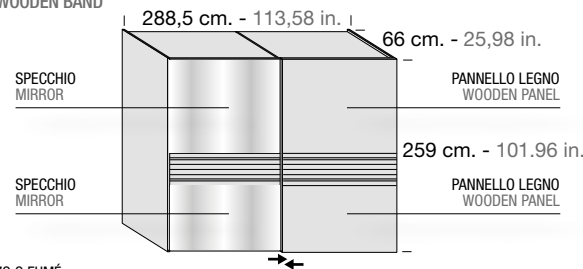

**ATTREZZATURA INTERNA:  
2 RIPIANI 4 TUBI APPENDIABITI**

**INTERIOR FITTINGS:  
2 SHELVES, 4 CLOTHES HANGING RAILS**

MAGG. FIANCHI ESTERNI IN NOCE  
CANALETTO OBBLIGATORIO PER  
FINITURA OLIO, CONSIGLIATO PER  
FINITURA HAVANA E ORIGINE + 321  
SURCH. FOR EXTERNAL SIDES IN  
CANALETTO WALNUT, COMPULSORY  
FOR OLIO FINISH, RECOMMENDED FOR  
HAVANA AND ORIGINE FINISH

CANALETTO

SPECIFICARE SE SPECCHI ARGENTO, BRONZO O FUMÉ  
SPECIFY MIRRORS COLOR: SILVER, BRONZE OR SMOKED

SHN8001K	OPTIONAL		
ACS3100K L. 140 H. 56	FASCIA BAND	ANTA SPORGENTE A SX FOR LH PROTRUDING DOOR	
	BICOLORE BICOLOR		
<b>5.150</b>	<b>+ 470</b>	<b>+ 5%</b>	<b>+ 5%</b>
mc 1,45 - Kg 130	mc 0,44 - Kg 54		

### MAGGIORAZIONI E RIDUZIONI SURCHARGES AND REDUCTIONS

RIDUZIONI SINGOLE  
SINGLE ADJUSTMENTS

LUNGHEZZA LENGTH	<b>+ 30%</b>
PROFONDITÀ DEPTH	
ALTEZZA HEIGHT	

RIDUZIONI COMBinate TRA LORO  
COMBINED ADJUSTMENTS

RIDUZIONE DI 2 MISURE REDUCTION OF 2 DIMENSIONS	<b>+ 40%</b>
--	--------------

ES. RIDUZIONE IN LUNGHEZZA +  
PROFONDITÀ O PROFONDITÀ + ALTEZZA ECC.  
EX. OF REDUCTION IN LENGTH +  
DEPTH OR DEPTH + HEIGHT ETC.

RIPIANI SP. 4 CM  
SHELVES TH. 4 CM

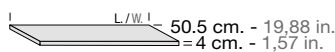

TUBO APPENDIABITI  
CLOTHES HANGING RAILS



ACS1014C	ACS1013C	ACS1012C	ACS1016C	ACS1011C
L. 45	L. 70	L. 90	L. 100	L. 140
<b>136</b>	<b>162</b>	<b>186</b>	<b>229</b>	<b>241</b>

ACS1104C	ACS1103C	ACS1102C	ACS1106C	ACS1101C
L. 45	L. 70	L. 90	L. 100	L. 140
<b>44</b>	<b>44</b>	<b>55</b>	<b>55</b>	<b>55</b>

mc 0,04 - Kg 4    mc 0,05 - Kg 8    mc 0,05 - Kg 11    mc 0,06 - Kg 13    mc 0,07 - Kg 15

# NOTTE - NIGHT

## ARMADI SCORREVOLI SLIDING DOOR WARDROBES

### SWING

2 ANTE SCORREVOLI CON 2 SPECCHI ORIZZONTALI  
SLIDING DOORS WITH 2 HORIZONTAL MIRRORS

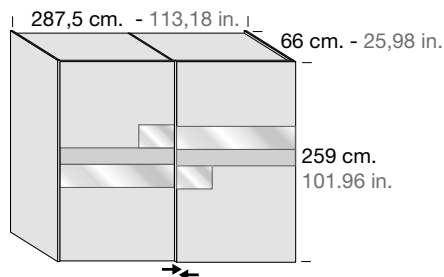

**ATTREZZATURA INTERNA:**  
2 RIPIANI 4 TUBI APPENDIABILI

**INTERIOR FITTINGS:**  
2 SHELVES, 4 CLOTHES HANGING RAILS

MAGG. FIANCHI ESTERNI IN NOCE  
CANALETTO OBBLIGATORIO PER  
FINITURA OLIO, CONSIGLIATO PER  
FINITURA HAVANA E ORIGINE  
SURCH. FOR EXTERNAL SIDES IN  
CANALETTO WALNUT, COMPULSORY  
FOR OIL FINISH, RECOMMENDED FOR  
HAVANA AND ORIGINE FINISH

+ 321

DOGA LEGNO LISCIA  
SPECIFICARE SE SPECCHI ARGENTO, BRONZO O FUMÉ  
PLAIN WOODEN SLAT  
SPECIFY MIRRORS COLOR: SILVER, BRONZE OR SMOKED

DOGA LEGNO LISCIA	OPTIONAL			
<b>DON8036K</b>	<b>ACS3100K</b> L. 140 H. 56	DOGA SLAT	DOGA QUADRO LEGNO	ANTA SPORGENTE A SX
		DOGA RIGHE	WOODEN SQUARE SLAT	FOR LH PROTRUDING DOOR
		RIBBED SLAT		
<b>5.100</b>	<b>+ 470</b>	<b>+ 297</b>	<b>+ 347</b>	<b>+ 5 %</b>
mc 1,45 – Kg 130	mc 0,44 – Kg 54			

### DIXIELAND

2 ANTE SCORREVOLI CON 2 SPECCHI VERTICALI E 1 SPECCHIO ORIZZONTALE  
2 SLIDING DOORS WITH 2 VERTICAL MIRRORS AND 1 HORIZONTAL MIRROR

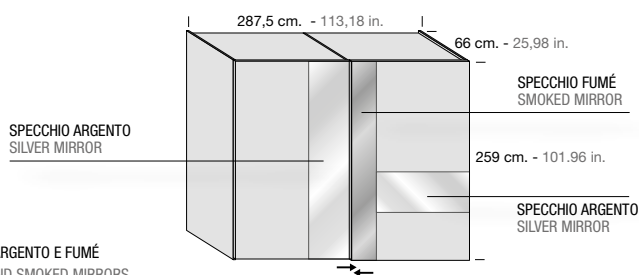

**ATTREZZATURA INTERNA:**  
2 RIPIANI 4 TUBI APPENDIABILI

**INTERIOR FITTINGS:**  
2 SHELVES, 4 CLOTHES HANGING RAILS

MAGG. FIANCHI ESTERNI IN NOCE  
CANALETTO OBBLIGATORIO PER  
FINITURA OLIO, CONSIGLIATO PER  
FINITURA HAVANA E ORIGINE  
SURCH. FOR EXTERNAL SIDES IN  
CANALETTO WALNUT, COMPULSORY  
FOR OIL FINISH, RECOMMENDED FOR  
HAVANA AND ORIGINE FINISH

+ 321

DOGA LEGNO LISCIA – SPECCHI ARGENTO E FUMÉ  
PLAIN WOODEN SLAT – SILVER AND SMOKED MIRRORS

DOGA LEGNO LISCIA	OPTIONAL	
<b>DON8091K</b>	<b>ACS3100K</b> L. 140 H. 56	ANTA SPORGENTE A SX
		FOR LH PROTRUDING DOOR
<b>5.200</b>	<b>+ 470</b>	<b>+ 5 %</b>
mc 1,30 – Kg 130	mc 0,44 – Kg 54	

### ATTREZZATURA INTERNA

**DECORATIVO COLOR  
OLMO SBIANCATO**

**INTERIOR FITTINGS**

**BLEACHED ELM  
DECORATIVE COLOR**

DIVISORIO INTERNO SP. 2.5  
INTERNAL PARTITIONS TH. 2.5

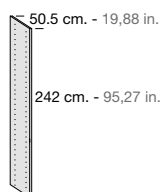

**ACS1022C**

**415**

mc 0,10 – Kg 24

DIVISORIO INTERNO SP. 2.5  
INTERNAL PARTITIONS TH. 2.5

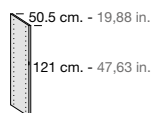

**ACS1021C**

**222**

mc 0,05 – Kg 10

KIT 2 LUCI LED IN ALLUMINIO  
VERTICALI H. 240  
KIT 2 ALUMINUM VERTICAL LED  
LIGHTS



CON SENSORE E TRASFORMATORE (1 DX E 1 SX)  
WITH SENSOR AND TRANSFORMER (1 RH AND 1 LH)

**ACS1080K**

**637**

**ARMADI BATTENTE  
HINGED DOOR WARDROBES**

STRUTTURA INTERNA DECORATIVO COLOR OLMO SBIANCATO ED ESTERNO NOCE TANGANIKA  
STRUCTURE INSIDE IN BLEACHED ELM DECORATIVE COLOR AND OUTSIDE IN TANGANIKA WALNUT

**HOLA 4 ANTE  
HOLA 4 DOORS**

4 ANTE BATTENTE CON FASCIA DECORATIVA IN LEGNO  
4 HINGED DOORS WITH DECORATIVE WOODEN BAND

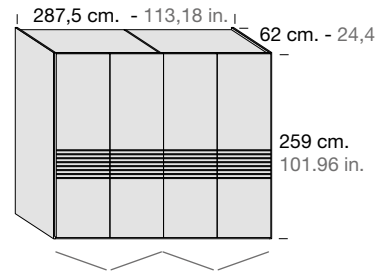

**ATTREZZATURA INTERNA:  
2 RIPIANI 4 TUBI APPENDIABILI**

**INTERIOR FITTINGS:  
2 SHELVES, 4 CLOTHES HANGING RAILS**

MAGG. FIANCHI ESTERNI IN NOCE  
CANALETTO OBBLIGATORIO PER  
FINITURA OLIO, CONSIGLIATO PER  
FINITURA HAVANA E ORIGINE  
SURCH. FOR EXTERNAL SIDES IN  
CANALETTO WALNUT, COMPULSORY  
FOR OLIO FINISH, RECOMMENDED FOR  
HAVANA AND ORIGINE FINISH **+ 321**

**CANALETTO**

APERTURA 2 MANIGLIE IN LEGNO MASSELLO - OPENING WITH 2 SOLID WOOD HANDLES

SHN8201K	OPTIONAL	
	ACS3100K L. 140 H. 56	FASCIA BAND
		BICOLORE BICOLOR
<b>5.450</b>	<b>+ 470</b>	<b>+ 5%</b>
mc 1,30 - Kg 130	mc 0,44 - Kg 54	

**HOLA 6 ANTE  
HOLA 6 DOORS**

6 ANTE BATTENTE CON FASCIA DECORATIVA IN LEGNO  
6 HINGED DOORS WITH DECORATIVE WOODEN BAND

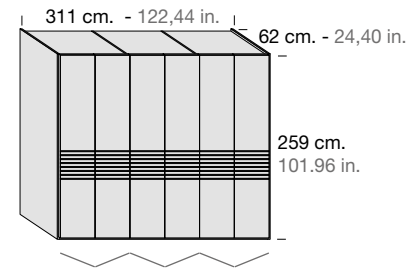

**ATTREZZATURA INTERNA:  
3 RIPIANI 6 TUBI APPENDIABILI**

**INTERIOR FITTINGS:  
3 SHELVES, 6 CLOTHES HANGING RAILS**

MAGG. FIANCHI ESTERNI IN NOCE  
CANALETTO OBBLIGATORIO PER  
FINITURA OLIO, CONSIGLIATO PER  
FINITURA HAVANA E ORIGINE  
SURCH. FOR EXTERNAL SIDES IN  
CANALETTO WALNUT, COMPULSORY  
FOR OLIO FINISH, RECOMMENDED FOR  
HAVANA AND ORIGINE FINISH **+ 321**

**CANALETTO**

APERTURA 3 MANIGLIE IN LEGNO MASSELLO - OPENING WITH 3 SOLID WOOD HANDLES

SHN8211K	OPTIONAL	
	ACS3110K L. 100 H. 56	FASCIA BAND
		BICOLORE BICOLOR
<b>7.396</b>	<b>+ 451</b>	<b>+ 5%</b>
mc 1,45 - Kg 130	mc 0,44 - Kg 54	

**MAGGIORAZIONI E RIDUZIONI  
SURCHARGES AND REDUCTIONS**

RIDUZIONI SINGOLE  
SINGLE ADJUSTMENTS

LUNGHEZZA LENGTH	<b>+ 30%</b>
PROFONDITÀ DEPTH	
ALTEZZA HEIGHT	

RIDUZIONI COMBinate TRA LORO  
COMBINED ADJUSTMENTS

RIDUZIONE DI 2 MISURE REDUCTION OF 2 DIMENSIONS	<b>+ 40%</b>
--	--------------

ES. RIDUZIONE IN LUNGHEZZA +  
PROFONDITÀ O PROFONDITÀ + ALTEZZA ECC.  
EX. OF REDUCTION IN LENGTH +  
DEPTH OR DEPTH + HEIGHT ETC.

RIPIANI SP. 4 CM  
SHELVES TH. 4 CM

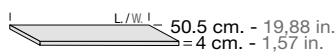

TUBO APPENDIABILI  
CLOTHES HANGING RAILS

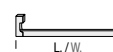

ACS1014C	ACS1013C	ACS1012C	ACS1016C	ACS1011C
L. 45	L. 70	L. 90	L. 100	L. 140
<b>136</b>	<b>162</b>	<b>186</b>	<b>229</b>	<b>241</b>

ACS1104C	ACS1103C	ACS1102C	ACS1106C	ACS1101C
L. 45	L. 70	L. 90	L. 100	L. 140
<b>44</b>	<b>44</b>	<b>55</b>	<b>55</b>	<b>55</b>

mc 0,04 - Kg 4    mc 0,05 - Kg 8    mc 0,05 - Kg 11    mc 0,06 - Kg 13    mc 0,07 - Kg 15

# NOTTE E GIORNO - NIGHT AND DAY

## COMPLEMENTI COMPLEMENTS

### BOISERIE WALL PANEL

**NEW**

#### FORMELLE IN LEGNO WOODEN TILES

FORMELLA A  
TILE A

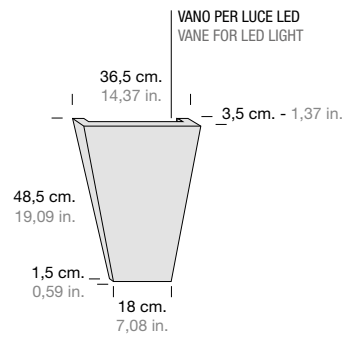

FORMELLA B  
TILE B

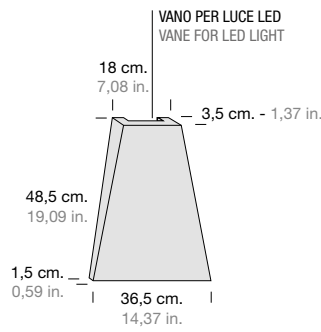

#### FORMELLA IN METALLO METAL TILE

FORMELLA C  
TILE C

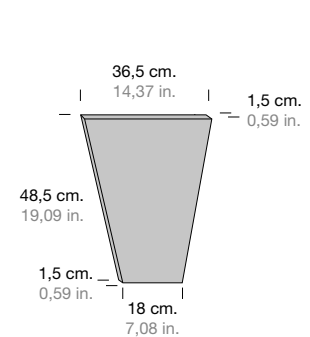

FORMELLA IN LEGNO "A" E "B"  
"A" AND "B" WOODEN TILE

FORMELLA IN METALLO "C"  
"C" METAL TILE

DEG7001K	DEG7011K	ELEMENTI AGGIUNTIVI - ADDITIONAL ELEMENTS		
		ACS7120C	ACS7013C	ACS7014C
PREZZO AL METRO QUADRO PRICE FOR SQUARE METER		LUCE LED PER METRO QUADRO LED LIGHT PER SQUARE METER	CORNICE LATERALE DI CHIUSURA L. 12 CM. PER MT. L. LATERAL CLOSING BAND W. 4,72 IN. PER L. M.	FASCIA SUPERIORE E INFERIORE H. 12 CM. PER MT. L. TOP AND LOWER BAND H. 4,72 IN. PER L. M.
<b>CANALETTO</b>	<b>1.850</b>	<b>500</b>	<b>70</b>	<b>70</b>
	mc 0,003 - Kg 3	mc 0,003 - Kg 5	mc 0,003 - Kg 2	mc 0,003 - Kg 2

### SCHEMA DI MONTAGGIO PER BOISERIE ASSEMBLY DIAGRAM FOR WALL PANELS

DOPO UN'ACCURATA MISURAZIONE DELLA PARETE CHE ANDRÀ AD OSPITARE LA BOISERIE VERRANNO REALIZZATI DEI PANNELLI SUI QUALI VERRANNO INSTALLATE LE FORMELLE. OGNI BOISERIE DOVRÀ AVERE 2 FASCE DI CHIUSURA LATERALI, 1 ZOCCOLO ED UNA FASCIA SUPERIORE. IL PREZZO È RIFERITO ALL'ESSENZA DI NOCE CANALETTO, MA SU RICHIESTA È POSSIBILE LA REALIZZAZIONE IN ALTRE ESSENZE DI LEGNO. AFTER AN ACCURATE MEASUREMENT OF THE WALL THAT WILL HOST THE BOISERIE, PANELS WILL BE CREATED ON WHICH THE TILES WILL BE INSTALLED. EACH WALL PANELING MUST HAVE 2 SIDE CLOSING BANDS, 1 PLINTH AND ONE TOP BAND. THE PRICE REFERS TO THE CANALETTO WALNUT ESSENCE, BUT IT CAN BE PRODUCED IN OTHER WOOD ESSENCES ON REQUEST.

ESEMPIO DI PANNELLO PREFORATO DA AVVITARE ALLA PARETE PER APPLICAZIONE DI 12 FORMELLE. SP. 1,5 CM.

EXAMPLE OF PRE-DRILLED PANEL TO BE SCREWED TO THE WALL FOR ATTACHING 12 TILES. THICK 0,59 IN.

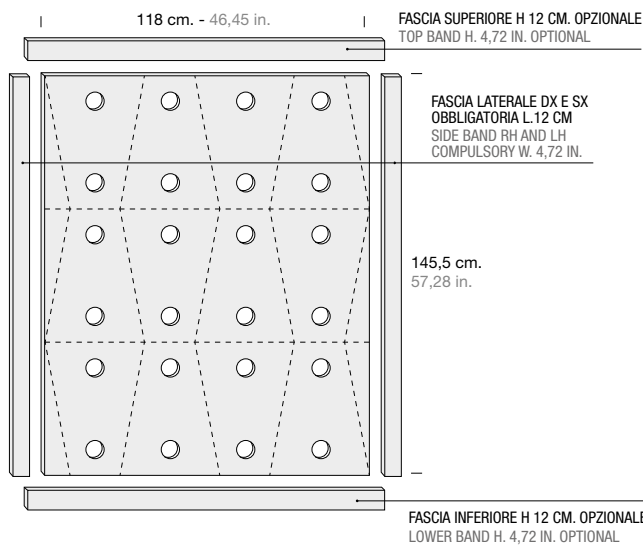

APPLICARE LE FORMELLE AL PANNELLO FISSATO AL MURO. SE PREVISTO COLLEGARE LE BARRE LED ALLA RETE ELETTRICA.

APPLY THE TILES TO THE PANEL FIXED TO THE WALL. IF APPLICABLE, CONNECT THE LED BARS TO THE ELECTRICITY MAINS.

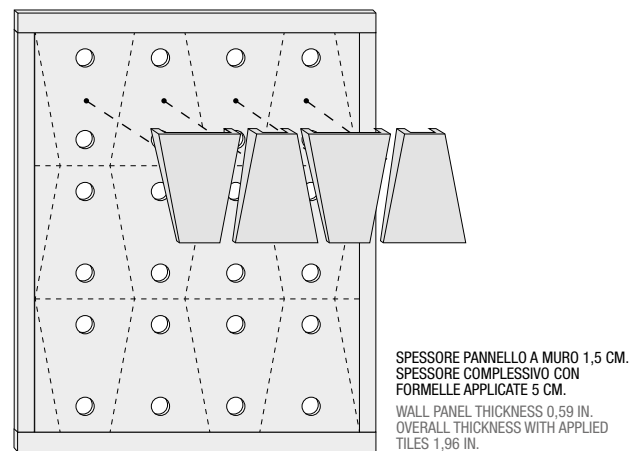

### ESEMPI DI POSIZIONAMENTO DELLE FORMELLE EXAMPLES OF TILE POSITIONING

ESEMPIO 1 - MONTAGGIO PER OTTENERE FONTI LUMINOSE PARALLELE  
EXAMPLE 1 - ASSEMBLY TO OBTAIN PARALLEL LIGHT SOURCES

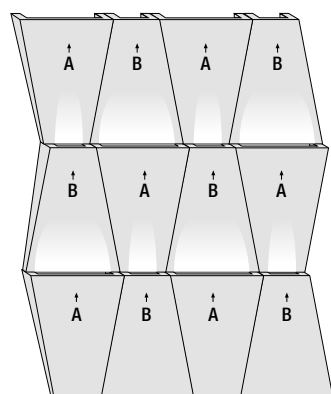

ESEMPIO 2 - MONTAGGIO PER OTTENERE FONTI LUMINOSE ALTERNATE  
EXAMPLE 2 - ASSEMBLY TO OBTAIN ALTERNATING LIGHT SOURCES

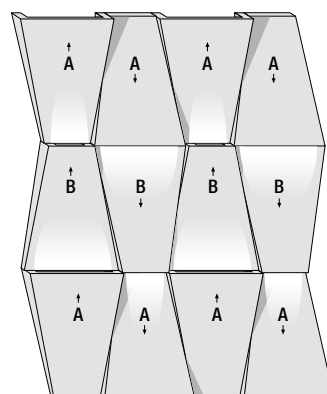

ESEMPIO 3 - MONTAGGIO CON ALTERNANZA DI MATERIALI  
EXAMPLE 3 - ASSEMBLY TO OBTAIN ALTERNATING MATERIALS

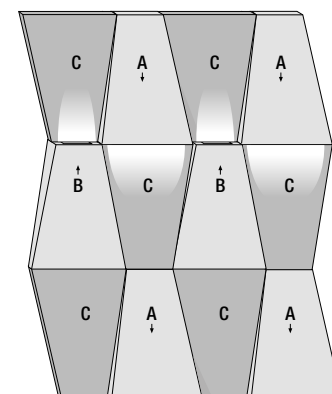

N.B. LA FRECCIA INDICA LA DIREZIONE DEL FASCIO LUMINOSO  
N.B. THE ARROW POINTS TO THE DIRECTION OF THE LIGHT BEAM

**03** \_ GIORNO E NOTTE  
DAY AND NIGHT

**107** \_ SISTEMA COMPONIBILE BOOK  
BOOK MODULAR SYSTEM

**127** \_ SISTEMA COMPONIBILE DOMINO  
DOMINO MODULAR SYSTEM

**179** \_ DIVANO COMPONIBILE PENTA  
PENTA MODULAR SOFA

- 108** ELEMENTI STRUTTURALI  
STRUCTURAL ELEMENTS
- 110** BASI A TERRA H. 40 - P. 48  
FLOOR-STANDING BASE UNITS H. 40 - D. 48
- 112** BASI A TERRA H. 50 - P. 48  
FLOOR-STANDING BASE UNITS H. 50 - D. 48
- 116** BASI A TERRA H. 60 - P. 48  
FLOOR-STANDING BASE UNITS H. 60 - D. 48
- 118** BASI A TERRA H. 80 - P. 48  
FLOOR-STANDING BASE UNITS H. 80 - D. 48
- 122** COMPOSIZIONI  
COMPOSITIONS

# SISTEMA COMPONIBILE BOOK - BOOK MODULAR SYSTEM

## ELEMENTI STRUTTURALI STRUCTURAL ELEMENTS

### PIANI IN LEGNO SP. 1 CM. (OBBLIGATORIO) WOODEN TOPS TH. 0,39 IN. (COMPULSORY)

#### TOP SQUADRATI SQUARE TOPS

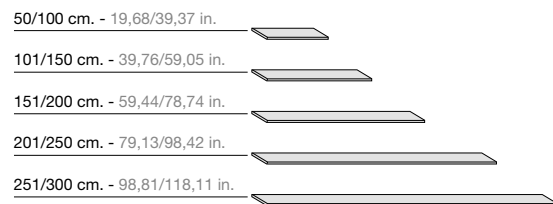

larghezza width	codice code	CANALETTO	
50/100   19,68/39,37	CUC1101K	250	mc 0,01 – Kg 7
101/150   39,76/59,05	CUC1102K	300	mc 0,01 – Kg 8
151/200   59,44/78,74	CUC1103K	390	mc 0,02 – Kg 9
201/250   79,13/98,42	CUC1104K	450	mc 0,03 – Kg 10
251/300   98,81/118,11	CUC1105K	500	mc 0,04 – Kg 12

#### TOP SAGOMATI SHAPED TOPS

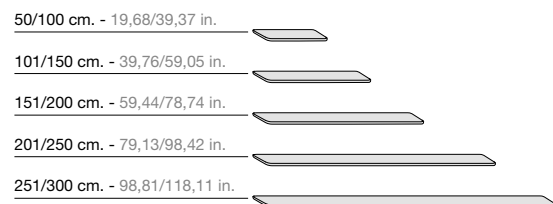

larghezza width	codice code	CANALETTO	
50/100   19,68/39,37	CUC1115K	275	mc 0,01 – Kg 7
101/150   39,76/59,05	CUC1116K	400	mc 0,01 – Kg 8
151/200   59,44/78,74	CUC1117K	450	mc 0,02 – Kg 9
201/250   79,13/98,42	CUC1118K	500	mc 0,03 – Kg 10
251/300   98,81/118,11	CUC1119K	600	mc 0,04 – Kg 12

### PIANI IN LEGNO SP. 4 CM. (OBBLIGATORIO) WOODEN TOPS TH. 1,57 IN. (COMPULSORY)

#### TOP SQUADRATI SQUARE TOPS

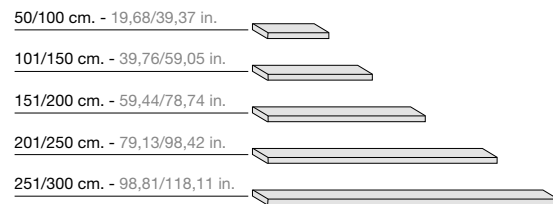

larghezza width	codice code	CANALETTO	
50/100   19,68/39,37	CUC1201K	360	mc 0,03 – Kg 9
101/150   39,76/59,05	CUC1202K	460	mc 0,05 – Kg 10
151/200   59,44/78,74	CUC1203K	600	mc 0,06 – Kg 11
201/250   79,13/98,42	CUC1204K	780	mc 0,08 – Kg 12
251/300   98,81/118,11	CUC1205K	800	mc 0,09 – Kg 14

#### TOP SAGOMATI SHAPED TOPS

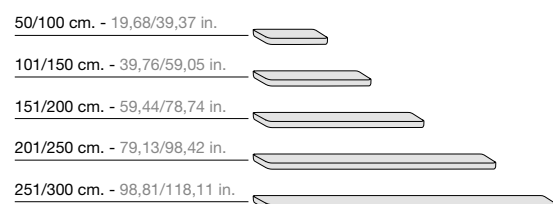

larghezza width	codice code	CANALETTO	
50/100   19,68/39,37	CUC1215K	380	mc 0,03 – Kg 9
101/150   39,76/59,05	CUC1216K	550	mc 0,05 – Kg 10
151/200   59,44/78,74	CUC1217K	665	mc 0,06 – Kg 11
201/250   79,13/98,42	CUC1218K	760	mc 0,08 – Kg 12
251/300   98,81/118,11	CUC1219K	950	mc 0,09 – Kg 14

### PIANI IN MARMO SP. 2 CM. (OBBLIGATORIO) MARBLE TOPS TH. 0,78 IN. (COMPULSORY)

#### TOP SQUADRATI SQUARE TOPS

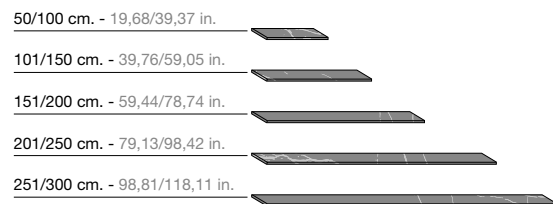

larghezza width	codice code	CANALETTO	
50/100   19,68/39,37	CUC1301K	755	mc 0,02 – Kg 23
101/150   39,76/59,05	CUC1302K	1.055	mc 0,03 – Kg 25
151/200   59,44/78,74	CUC1303K	1.355	mc 0,04 – Kg 27
201/250   79,13/98,42	CUC1304K	1.670	mc 0,05 – Kg 30
251/300   98,81/118,11	CUC1305K	1.950	mc 0,55 – Kg 35

#### TOP SAGOMATI SHAPED TOPS

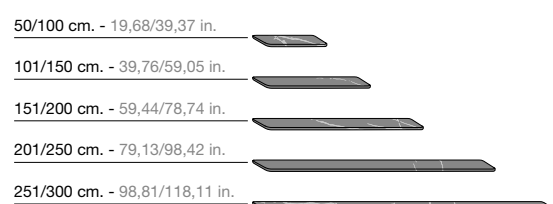

larghezza width	codice code	CANALETTO	
50/100   19,68/39,37	CUC1315K	915	mc 0,02 – Kg 23
101/150   39,76/59,05	CUC1316K	1.215	mc 0,03 – Kg 25
151/200   59,44/78,74	CUC1317K	1.570	mc 0,04 – Kg 27
201/250   79,13/98,42	CUC1318K	1.910	mc 0,05 – Kg 30
251/300   98,81/118,11	CUC1319K	2.190	mc 0,55 – Kg 35

## FONDO (OBBLIGATORIO PER MODULI COMPOSTI) BASE (COMPULSORY FOR MODULAR COMPOSITION)

### FONDI QUADRATI SQUARE BASES

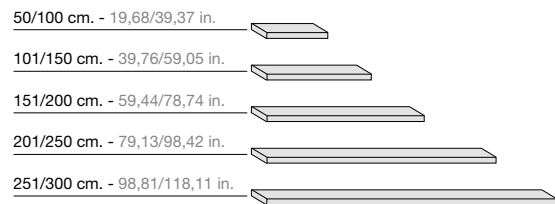

larghezza width	codice code	CANALETTO	
50/100   19,68/39,37	<b>CUC1001K</b>	<b>360</b>	mc 0,03 - Kg 9
101/150   39,76/59,05	<b>CUC1002K</b>	<b>460</b>	mc 0,05 - Kg 10
151/200   59,44/78,74	<b>CUC1003K</b>	<b>600</b>	mc 0,06 - Kg 11
201/250   79,13/98,42	<b>CUC1004K</b>	<b>780</b>	mc 0,08 - Kg 12
251/300   98,81/118,11	<b>CUC1005K</b>	<b>800</b>	mc 0,09 - Kg 14

### FONDI SAGOMATI SHAPED BASES

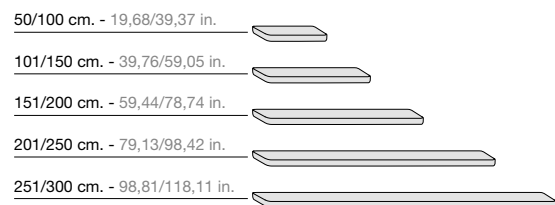

larghezza width	codice code	CANALETTO	
50/100   19,68/39,37	<b>CUC1015K</b>	<b>380</b>	mc 0,03 - Kg 9
101/150   39,76/59,05	<b>CUC1016K</b>	<b>550</b>	mc 0,05 - Kg 10
151/200   59,44/78,74	<b>CUC1017K</b>	<b>665</b>	mc 0,06 - Kg 11
201/250   79,13/98,42	<b>CUC1018K</b>	<b>760</b>	mc 0,08 - Kg 12
251/300   98,81/118,11	<b>CUC1019K</b>	<b>950</b>	mc 0,09 - Kg 14

## FIANCHI IN LEGNO L. 6 CM, P. 48 CM. (OBBLIGATORIO) WOODEN SIDES W. 2,36 IN. D. 18,89 IN. (COMPULSORY)

### FIANCHI SAGOMATI SHAPED SIDES

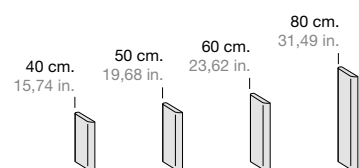

larghezza width	codice code	CANALETTO	
40   15,74	<b>CUC7011K</b>	<b>250</b>	mc 0,02 - Kg 3
50   16,68	<b>CUC7021K</b>	<b>280</b>	mc 0,03 - Kg 3,5
60   23,62	<b>CUC7041K</b>	<b>290</b>	mc 0,03 - Kg 3
80   31,49	<b>CUC7031K</b>	<b>300</b>	mc 0,03 - Kg 4,5

## GAMBE LEGS

### COPPIA DI GAMBE IN METALLO PAIR OF METAL LEGS



altezza height	codice code		
14   5,51	<b>CUC9001K</b>	<b>350</b>	mc 0,02 - Kg 5

### COPPIA DI GAMBE IN VETRO PAIR OF GLASS LEGS

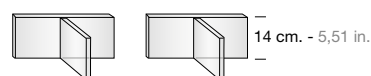

altezza height	codice code		
14   5,51	<b>CUC9101K</b>	<b>400</b>	mc 0,06 - Kg 3

# SISTEMA COMPONIBILE BOOK - BOOK MODULAR SYSTEM

**BASI A TERRA P. 48 CM.**

**FLOOR-STANDING BASE UNITS D. 18,89 IN.**

**BASI H. 40 CM.**

**BASE UNITS H. 15,74 IN.**

1 ANTA BATTENTE LISCIA,  
1 RIPIANO INTERNO IN VETRO  
1 SMOOTH HINGED DOOR,  
1 INNER GLASS SHELF

50 cm.  
19,68 in.



1 ANTA BATTENTE LISCIA,  
1 RIPIANO INTERNO IN VETRO  
1 SMOOTH HINGED DOOR,  
1 INNER GLASS SHELF

65 cm.  
25,59 in.



**OBBLIGATORIO: AGGIUNGERE  
PIEDI IN METALLO**  
**COMPULSORY: ADD METAL FEET.**

**DX - CUC2313K**  
**SX - CUC2413K**

**DX - CUC2314K**  
**SX - CUC2414K**

**CANALETTO**

**950**

**1.000**

mc 0,17 – Kg 20

mc 0,22 – Kg 22

3 ANTE BATTENTI LISCE,  
2 RIPIANI INTERNI IN VETRO  
3 SMOOTH HINGED DOORS,  
2 INNER GLASS SHELVES

150 cm.  
59,05 in.



4 ANTE BATTENTI LISCE,  
2 RIPIANI INTERNI IN VETRO  
4 SMOOTH HINGED DOORS,  
2 INNER GLASS SHELVES

200 cm.  
78,74 in.



**OBBLIGATORIO: AGGIUNGERE  
PIEDI IN METALLO**  
**COMPULSORY: ADD METAL FEET.**

**CUC2318K**

**CUC2317K**

**CANALETTO**

**1.850**

**2.500**

mc 0,39 – Kg 40

mc 0,68 – Kg 56

2 ANTE BATTENTI CON MANIGLIE,  
1 RIPIANO INTERNO IN VETRO  
2 HINGED DOORS WITH HANDLES,  
1 INNER GLASS SHELF

100 cm.  
39,37 in.



2 ANTE BATTENTI CON MANIGLIE,  
1 RIPIANO INTERNO IN VETRO  
2 HINGED DOORS WITH HANDLES,  
1 INNER GLASS SHELF

130 cm.  
51,18 in.

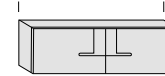

**OBBLIGATORIO: AGGIUNGERE  
PIEDI IN METALLO**  
**COMPULSORY: ADD METAL FEET.**

**CUC2015K**

**CUC2016K**

**CANALETTO**

**2.200**

**2.400**

mc 0,34 – Kg 28

mc 0,44 – Kg 34

4 ANTE BATTENTI CON MANIGLIE,  
2 RIPIANI INTERNI IN VETRO  
4 HINGED DOORS WITH HANDLES,  
2 INNER GLASS SHELVES

200 cm.  
78,74 in.



2 ANTE LISCE E 2 ANTE CON MANIGLIA  
2 RIPIANI INTERNI IN VETRO  
2 SMOOTH DOOR AND 2 DOOR WITH  
HANDLES, 2 INTERNAL GLASS SHELVES

200 cm.  
78,74 in.



**OBBLIGATORIO: AGGIUNGERE  
PIEDI IN METALLO**  
**COMPULSORY: ADD METAL FEET.**

**CUC2017K**

**CUC2018K**

**CANALETTO**

**4.000**

**3.200**

mc 0,68 – Kg 56

mc 0,68 – Kg 56



2 ANTE BATTENTI LISCE,  
1 RIPIANO INTERNO IN VETRO  
2 SMOOTH HINGED DOORS,  
1 INNER GLASS SHELF

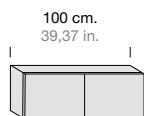

2 ANTE BATTENTI LISCE,  
1 RIPIANO INTERNO IN VETRO  
2 SMOOTH HINGED DOORS,  
1 INNER GLASS SHELF



<b>CUC2315K</b>	
<b>1.300</b>	
mc 0,34 – Kg 28	

<b>CUC2316K</b>	
<b>1.500</b>	
mc 0,44 – Kg 34	

1 ANTA BATTENTE CON MANIGLIA,  
1 RIPIANO INTERNO IN VETRO  
1 HINGED DOOR WITH HANDLE,  
1 INNER GLASS SHELF

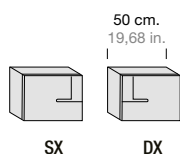

1 ANTA BATTENTE CON MANIGLIA,  
1 RIPIANO INTERNO IN VETRO  
1 HINGED DOOR WITH HANDLE,  
1 INNER GLASS SHELF

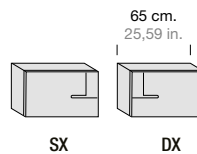

<b>DX - CUC2013K</b>	
<b>SX - CUC2113K</b>	
<b>1.325</b>	
mc 0,17 – Kg 20	

<b>DX - CUC2014K</b>	
<b>SX - CUC2114K</b>	
<b>1.400</b>	
mc 0,22 – Kg 22	

1 ANTA LISCIA E 2 ANTE CON MANIGLIA  
2 RIPIANI INTERNI IN VETRO  
1 SMOOTH DOOR AND 2 DOOR WITH  
HANDLES, 2 INTERNAL GLASS SHELVES

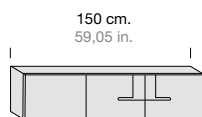

1 ANTA LISCIA E 2 ANTE CON MANIGLIA  
2 RIPIANI INTERNI IN VETRO  
1 SMOOTH DOOR AND 2 DOOR WITH  
HANDLES, 2 INTERNAL GLASS SHELVES

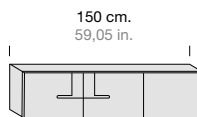

<b>CUC2115K</b>	
<b>2.800</b>	
mc 0,39 – Kg 40	

<b>CUC2116K</b>	
<b>2.800</b>	
mc 0,39 – Kg 40	

2 ANTE LISCE E 2 ANTE CON MANIGLIA  
2 RIPIANI INTERNI IN VETRO  
2 SMOOTH DOOR AND 2 DOOR WITH  
HANDLES, 2 INTERNAL GLASS SHELVES

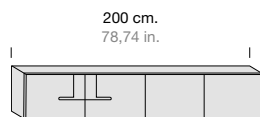

<b>CUC2019K</b>	
<b>3.200</b>	
mc 0,68 – Kg 56	

# SISTEMA COMPONIBILE BOOK - BOOK MODULAR SYSTEM

**BASI A TERRA P. 48 CM.**

**FLOOR-STANDING BASE UNITS D. 18,89 IN.**

**BASI H. 40 CM.**

**BASE UNITS H. 15,74 IN.**

2 CASSETTI  
2 DRAWERS

2 CASSETTI  
2 DRAWERS

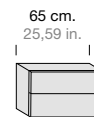

**OBBLIGATORIO: AGGIUNGERE  
PIEDI IN METALLO**  
COMPULSORY: ADD METAL FEET.

<b>CUC2060K</b>	
<b>1.020</b>	
mc 0,17 – Kg 21	

<b>CUC2061K</b>	
<b>1.155</b>	
mc 0,22 – Kg 23	

CANALETTO

TECA IN METALLO CON 1 RIPIANO  
METAL CASE WITH 1 SHELF

TECA IN METALLO CON 1 RIPIANO  
METAL CASE WITH 1 SHELF

TECA IN VETRO CON 1 RIPIANO IN VETRO  
GLASS CASE WITH 1 GLASS SHELF



**OBBLIGATORIO: AGGIUNGERE  
PIEDI IN METALLO**  
COMPULSORY: ADD METAL FEET.

<b>CUC4011K</b>	
<b>350</b>	
mc 0,05 – Kg 4	

<b>CUC4012K</b>	
<b>395</b>	
mc 0,07 – Kg 6	

VETRO TRASPARENTE  
TRANSPARENT GLASS

<b>CUC3013K</b>	<b>OPTIONAL</b>	
<b>495</b>	VETRO FUMÉ SMOKED GLASS	LUCE LED LED LIGHT
mc 0,11 – Kg 8	<b>+ 50</b>	<b>+ 200</b>

CANALETTO

**BASI H. 50 CM.**

**BASE UNITS H. 19,68 IN.**

1 ANTA BATTENTE LISCIA,  
1 RIPIANO INTERNO IN VETRO  
1 SMOOTH HINGED DOOR,  
1 INNER GLASS SHELF

1 ANTA BATTENTE LISCIA,  
1 RIPIANO INTERNO IN VETRO  
1 SMOOTH HINGED DOOR,  
1 INNER GLASS SHELF

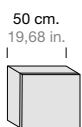

**OBBLIGATORIO: AGGIUNGERE  
PIEDI IN METALLO**  
COMPULSORY: ADD METAL FEET.

<b>DX - CUC2323K</b>	
<b>SX - CUC2423K</b>	
<b>1.050</b>	
mc 0,20 – Kg 25	

<b>DX - CUC2324K</b>	
<b>SX - CUC2424K</b>	
<b>1.150</b>	
mc 0,27 – Kg 28	

CANALETTO

3 ANTE BATTENTI LISCE,  
2 RIPIANI INTERNI IN VETRO  
3 SMOOTH HINGED DOORS,  
2 INNER GLASS SHELVES

4 ANTE BATTENTI LISCE,  
2 RIPIANI INTERNI IN VETRO  
4 SMOOTH HINGED DOORS,  
2 INNER GLASS SHELVES

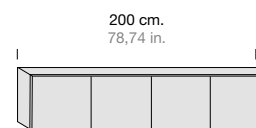
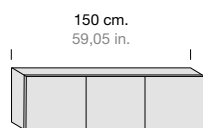

**OBBLIGATORIO: AGGIUNGERE  
PIEDI IN METALLO**  
COMPULSORY: ADD METAL FEET.

<b>CUC2328K</b>	
<b>2.200</b>	
mc 0,47 – Kg 50	

<b>CUC2327K</b>	
<b>2.900</b>	
mc 0,82 – Kg 76	

CANALETTO

2 CASSETTI  
2 DRAWERS

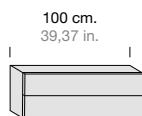

<b>CUC2062K</b>	
<b>1.505</b>	
mc 0,34 – Kg 29	

2 CASSETTI  
2 DRAWERS

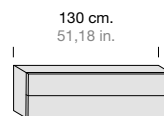

<b>CUC2063K</b>	
<b>1.785</b>	
mc 0,44 – Kg 34	

TECA IN VETRO CON 1 RIPIANO IN VETRO  
GLASS CASE WITH 1 GLASS SHELF

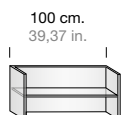

VETRO TRASPARENTE  
TRANSPARENT GLASS

<b>CUC3018K</b>	<b>OPTIONAL</b>	
	VETRO FUMÉ SMOKED GLASS	LUCE LED LED LIGHT
<b>610</b>	<b>+ 50</b>	<b>+ 200</b>
mc 0,23 – Kg 16		

TECA IN VETRO CON 1 RIPIANO IN VETRO  
GLASS CASE WITH 1 GLASS SHELF

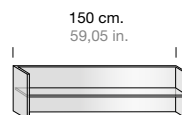

VETRO TRASPARENTE  
TRANSPARENT GLASS

<b>CUC3023K</b>	<b>OPTIONAL</b>	
	VETRO FUMÉ SMOKED GLASS	LUCE LED LED LIGHT
<b>728</b>	<b>+ 50</b>	<b>+ 200</b>
mc 0,50 – Kg 24		

2 ANTE BATTENTI LISCE,  
1 RIPIANO INTERNO IN VETRO  
2 SMOOTH HINGED DOORS,  
1 INNER GLASS SHELF

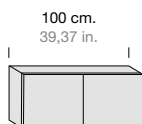

<b>CUC2325K</b>	
<b>1.450</b>	
mc 0,41 – Kg 38	

2 ANTE BATTENTI LISCE,  
1 RIPIANO INTERNO IN VETRO  
2 SMOOTH HINGED DOORS,  
1 INNER GLASS SHELF

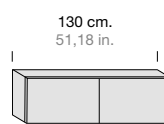

<b>CUC2326K</b>	
<b>1.500</b>	
mc 0,44 – Kg 34	

1 ANTA BATTENTE CON MANIGLIA,  
1 RIPIANO INTERNO IN VETRO  
1 HINGED DOOR WITH HANDLE,  
1 INNER GLASS SHELF

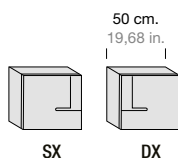

<b>DX - CUC2023K</b>	
<b>SX - CUC2123K</b>	
<b>1.550</b>	
mc 0,20 – Kg 25	

1 ANTA BATTENTE CON MANIGLIA,  
1 RIPIANO INTERNO IN VETRO  
1 HINGED DOOR WITH HANDLE,  
1 INNER GLASS SHELF

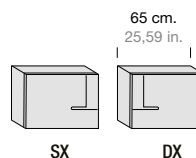

<b>DX - CUC2024K</b>	
<b>SX - CUC2124K</b>	
<b>1.590</b>	
mc 0,27 – Kg 28	

# SISTEMA COMPONIBILE BOOK - BOOK MODULAR SYSTEM

**BASI A TERRA P. 48 CM.**

**FLOOR-STANDING BASE UNITS D. 18,89 IN.**

**BASI H. 50 CM.**

**BASE UNITS H. 19,68 IN.**

2 ANTE BATTENTI CON MANIGLIE,  
1 RIPIANO INTERNO IN VETRO  
2 HINGED DOORS WITH HANDLES,  
1 INNER GLASS SHELF

2 ANTE BATTENTI CON MANIGLIE,  
1 RIPIANO INTERNO IN VETRO  
2 HINGED DOORS WITH HANDLES,  
1 INNER GLASS SHELF

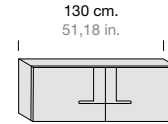
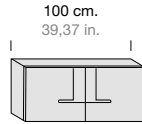

**OBBLIGATORIO: AGGIUNGERE  
PIEDI IN METALLO**  
**COMPULSORY: ADD METAL FEET.**



**CANALETTO**



mc 0,41 – Kg 38

mc 0,44 – Kg 34

4 ANTE BATTENTI CON MANIGLIE,  
2 RIPIANI INTERNI IN VETRO  
4 HINGED DOORS WITH HANDLES,  
2 INNER GLASS SHELVES

2 ANTE LISCE E 2 ANTE CON MANIGLIA  
2 RIPIANI INTERNI IN VETRO  
2 SMOOTH DOOR AND 2 DOOR WITH  
HANDLES, 2 INTERNAL GLASS SHELVES

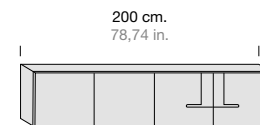
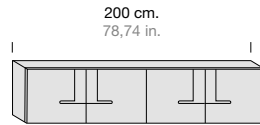

**OBBLIGATORIO: AGGIUNGERE  
PIEDI IN METALLO**  
**COMPULSORY: ADD METAL FEET.**



**CANALETTO**

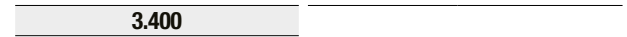

mc 0,82 – Kg 76

mc 0,82 – Kg 76

2 CASSETTI  
2 DRAWERS

2 CASSETTI  
2 DRAWERS

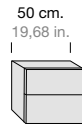

**OBBLIGATORIO: AGGIUNGERE  
PIEDI IN METALLO**  
**COMPULSORY: ADD METAL FEET.**



**CANALETTO**



mc 0,20 – Kg 26

mc 0,27 – Kg 29

TECA IN METALLO CON 1 RIPIANO  
METAL CASE WITH 1 SHELF

TECA IN METALLO CON 1 RIPIANO  
METAL CASE WITH 1 SHELF

TECA IN VETRO CON 1 RIPIANO IN VETRO  
GLASS CASE WITH 1 GLASS SHELF



**OBBLIGATORIO: AGGIUNGERE  
PIEDI IN METALLO**  
**COMPULSORY: ADD METAL FEET.**



VETRO TRASPARENTE  
TRANSPARENT GLASS



**OPTIONAL**

**CANALETTO**



VETRO FUMÉ  
SMOKED GLASS

**+ 50**

LUCE LED  
LED LIGHT

**+ 200**

mc 0,07 – Kg 5

mc 0,09 – Kg 7

mc 0,07 – Kg 9

1 ANTA LISCIA E 2 ANTE CON MANIGLIA  
2 RIPIANI INTERNI IN VETRO  
1 SMOOTH DOOR AND 2 DOOR WITH  
HANDLES, 2 INTERNAL GLASS SHELVES

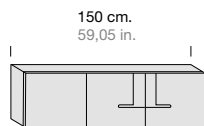

<b>CUC2125K</b>	
<b>2.990</b>	
mc 0,43 – Kg 45	

1 ANTA LISCIA E 2 ANTE CON MANIGLIA  
2 RIPIANI INTERNI IN VETRO  
1 SMOOTH DOOR AND 2 DOOR WITH  
HANDLES, 2 INTERNAL GLASS SHELVES

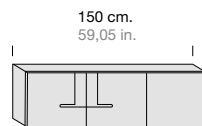

<b>CUC2126K</b>	
<b>2.990</b>	
mc 0,43 – Kg 45	

2 ANTE LISCE E 2 ANTE CON MANIGLIA  
2 RIPIANI INTERNI IN VETRO  
2 SMOOTH DOOR AND 2 DOOR WITH  
HANDLES, 2 INTERNAL GLASS SHELVES

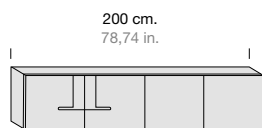

<b>CUC2029K</b>	
<b>3.400</b>	
mc 0,82 – Kg 76	

2 CASSETTI  
2 DRAWERS

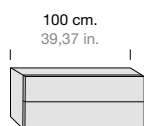

<b>CUC2072K</b>	
<b>1.625</b>	
mc 0,41 – Kg 39	

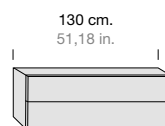

<b>CUC2073K</b>	
<b>1.940</b>	
mc 0,44 – Kg 35	

TECA IN VETRO CON 1 RIPIANO IN VETRO  
GLASS CASE WITH 1 GLASS SHELF

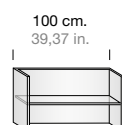

VETRO TRASPARENTE TRANSPARENT GLASS	<b>OPTIONAL</b>	
<b>CUC3038K</b>	VETRO FUMÉ SMOKED GLASS	LUCE LED LED LIGHT
<b>655</b>	<b>+ 50</b>	<b>+ 200</b>
mc 0,28 – Kg 18		

TECA IN VETRO CON 1 RIPIANO IN VETRO  
GLASS CASE WITH 1 GLASS SHELF

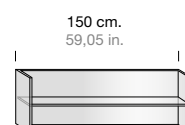

VETRO TRASPARENTE TRANSPARENT GLASS	<b>OPTIONAL</b>	
<b>CUC3043K</b>	VETRO FUMÉ SMOKED GLASS	LUCE LED LED LIGHT
<b>800</b>	<b>+ 50</b>	<b>+ 200</b>
mc 0,36 – Kg 27		

# SISTEMA COMPONIBILE BOOK - BOOK MODULAR SYSTEM

**BASI A TERRA P. 48 CM.**

**FLOOR-STANDING BASE UNITS D. 18,89 IN.**

**BASI H. 60 CM.**

**BASE UNITS H. 23,62 IN.**

1 ANTA BATTENTE LISCIA,  
1 RIPIANO INTERNO IN VETRO  
1 SMOOTH HINGED DOOR,  
1 INNER GLASS SHELF

50 cm.  
19,68 in.



1 ANTA BATTENTE LISCIA,  
1 RIPIANO INTERNO IN VETRO  
1 SMOOTH HINGED DOOR,  
1 INNER GLASS SHELF

65 cm.  
25,59 in.



**OBBLIGATORIO: AGGIUNGERE  
PIEDI IN METALLO**  
**COMPULSORY: ADD METAL FEET.**

**DX - CUC2443K**

**SX - CUC2343K**

**DX - CUC2444K**

**SX - CUC2443K**

**CANALETTO**

**1.145**

mc 0,25 - Kg 27

**1.235**

mc 0,29 - Kg 30

3 ANTE BATTENTI LISCE,  
2 RIPIANI INTERNI IN VETRO  
3 SMOOTH HINGED DOORS,  
2 INNER GLASS SHELVES

150 cm.  
59,05 in.



4 ANTE BATTENTI LISCE,  
2 RIPIANI INTERNI IN VETRO  
4 SMOOTH HINGED DOORS,  
2 INNER GLASS SHELVES

200 cm.  
78,74 in.



**OBBLIGATORIO: AGGIUNGERE  
PIEDI IN METALLO**  
**COMPULSORY: ADD METAL FEET.**

**CUC2348K**

**CUC2347K**

**CANALETTO**

**2.700**

mc 0,65 - Kg 78

**3.050**

mc 0,85 - Kg 80

2 ANTE BATTENTI CON MANIGLIE,  
1 RIPIANO INTERNO IN VETRO  
2 HINGED DOORS WITH HANDLES,  
1 INNER GLASS SHELF

100 cm.  
39,37 in.



2 ANTE BATTENTI CON MANIGLIE,  
1 RIPIANO INTERNO IN VETRO  
2 HINGED DOORS WITH HANDLES,  
1 INNER GLASS SHELF

130 cm.  
51,18 in.



**OBBLIGATORIO: AGGIUNGERE  
PIEDI IN METALLO**  
**COMPULSORY: ADD METAL FEET.**

**CUC2045K**

**CUC2046K**

**CANALETTO**

**2.740**

mc 0,45 - Kg 40

**2.900**

mc 0,47 - Kg 44

4 ANTE BATTENTI CON MANIGLIE,  
2 RIPIANI INTERNI IN VETRO  
4 HINGED DOORS WITH HANDLES,  
2 INNER GLASS SHELVES

200 cm.  
78,74 in.



2 ANTE LISCE E 2 ANTE CON MANIGLIA  
2 RIPIANI INTERNI IN VETRO  
2 SMOOTH DOOR AND 2 DOOR WITH  
HANDLES, 2 INTERNAL GLASS SHELVES

200 cm.  
78,74 in.



**OBBLIGATORIO: AGGIUNGERE  
PIEDI IN METALLO**  
**COMPULSORY: ADD METAL FEET.**

**CUC2047K**

**CUC2048K**

**CANALETTO**

**5.150**

mc 0,85 - Kg 80

**3.850**

mc 0,85 - Kg 80

2 ANTE BATTENTI LISCE,  
1 RIPIANO INTERNO IN VETRO  
2 SMOOTH HINGED DOORS,  
1 INNER GLASS SHELF

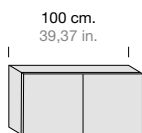

<b>CUC2345K</b>	
<b>1.580</b>	
mc 0,45 – Kg 40	

2 ANTE BATTENTI LISCE,  
1 RIPIANO INTERNO IN VETRO  
2 SMOOTH HINGED DOORS,  
1 INNER GLASS SHELF

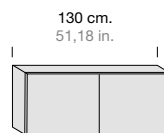

<b>CUC2346K</b>	
<b>1.780</b>	
mc 0,47 – Kg 44	

1 ANTA BATTENTE CON MANIGLIA,  
1 RIPIANO INTERNO IN VETRO  
1 HINGED DOOR WITH HANDLE,  
1 INNER GLASS SHELF

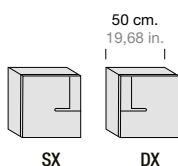

<b>DX - CUC2143K</b>	
<b>SX - CUC2043K</b>	
<b>1.675</b>	
mc 0,25 – Kg 27	

1 ANTA BATTENTE CON MANIGLIA,  
1 RIPIANO INTERNO IN VETRO  
1 HINGED DOOR WITH HANDLE,  
1 INNER GLASS SHELF

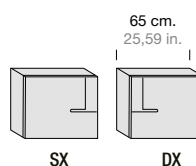

<b>DX - CUC2144K</b>	
<b>SX - CUC2044K</b>	
<b>1.755</b>	
mc 0,29 – Kg 30	

1 ANTA LISCIA E 2 ANTE CON MANIGLIA  
2 RIPIANI INTERNI IN VETRO  
1 SMOOTH DOOR AND 2 DOOR WITH  
HANDLES, 2 INTERNAL GLASS SHELVES

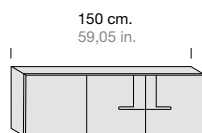

<b>CUC2145K</b>	
<b>3.270</b>	
mc 0,65 – Kg 78	

1 ANTA LISCIA E 2 ANTE CON MANIGLIA  
2 RIPIANI INTERNI IN VETRO  
1 SMOOTH DOOR AND 2 DOOR WITH  
HANDLES, 2 INTERNAL GLASS SHELVES

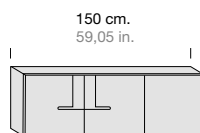

<b>CUC2146K</b>	
<b>3.270</b>	
mc 0,65 – Kg 78	

2 ANTE LISCE E 2 ANTE CON MANIGLIA  
2 RIPIANI INTERNI IN VETRO  
2 SMOOTH DOOR AND 2 DOOR WITH  
HANDLES, 2 INTERNAL GLASS SHELVES

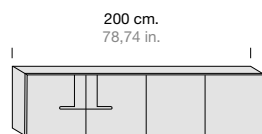

<b>CUC2049K</b>	
<b>3.850</b>	
mc 0,85 – Kg 80	

# SISTEMA COMPONIBILE BOOK - BOOK MODULAR SYSTEM

## BASI A TERRA P. 48 CM.

### FLOOR-STANDING BASE UNITS D. 18,89 IN.

#### BASI H. 60 CM.

BASE UNITS H. 23,62 IN.

2 CASSETTI  
2 DRAWERS

2 CASSETTI  
2 DRAWERS

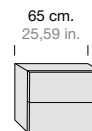
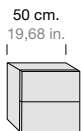

**OBBLIGATORIO: AGGIUNGERE  
PIEDI IN METALLO**  
COMPULSORY: ADD METAL FEET.

<b>CUC2090K</b>	
<b>1.330</b>	
mc 0,25 – Kg 29	

<b>CUC2091K</b>	
<b>1.500</b>	
mc 0,29 – Kg 32	

CANALETTO

TECA IN METALLO CON 1 RIPIANO  
METAL CASE WITH 1 SHELF

TECA IN METALLO CON 1 RIPIANO  
METAL CASE WITH 1 SHELF

TECA IN VETRO CON 1 RIPIANO IN VETRO  
GLASS CASE WITH 1 GLASS SHELF

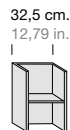

**OBBLIGATORIO: AGGIUNGERE  
PIEDI IN METALLO**  
COMPULSORY: ADD METAL FEET.

<b>CUC4041K</b>	
<b>470</b>	
mc 0,08 – Kg 6	

<b>CUC4042K</b>	
<b>580</b>	
mc 0,10 – Kg 8	

VETRO TRASPARENTE  
TRANSPARENT GLASS

<b>CUC3073K</b>	<b>OPTIONAL</b>	
<b>645</b>	VETRO FUMÉ SMOKED GLASS	LUCE LED LED LIGHT
mc 0,16 – Kg 12	<b>+ 50</b>	<b>+ 200</b>

CANALETTO

#### BASI H. 80 CM.

BASE UNITS H. 31,49 IN.

1 ANTA BATTENTE LISCIA,  
1 RIPIANO INTERNO IN VETRO  
1 SMOOTH HINGED DOOR,  
1 INNER GLASS SHELF

1 ANTA BATTENTE LISCIA,  
1 RIPIANO INTERNO IN VETRO  
1 SMOOTH HINGED DOOR,  
1 INNER GLASS SHELF

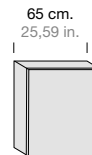
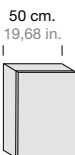

**OBBLIGATORIO: AGGIUNGERE  
PIEDI IN METALLO**  
COMPULSORY: ADD METAL FEET.

<b>DX - CUC2333K</b>	
<b>SX - CUC2433K</b>	
<b>1.240</b>	
mc 0,19 – Kg 27	

<b>DX - CUC2334K</b>	
<b>SX - CUC2434K</b>	
<b>1.320</b>	
mc 0,25 – Kg 30	

CANALETTO

3 ANTE BATTENTI LISCE,  
2 RIPIANI INTERNI IN VETRO  
3 SMOOTH HINGED DOORS,  
2 INNER GLASS SHELVES

4 ANTE BATTENTI LISCE,  
2 RIPIANI INTERNI IN VETRO  
4 SMOOTH HINGED DOORS,  
2 INNER GLASS SHELVES

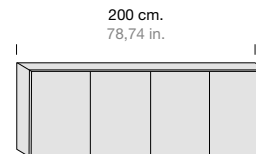
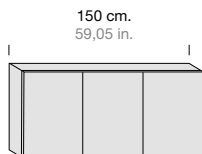

**OBBLIGATORIO: AGGIUNGERE  
PIEDI IN METALLO**  
COMPULSORY: ADD METAL FEET.

<b>CUC2338K</b>	
<b>2.900</b>	
mc 0,60 – Kg 865	

<b>CUC2337K</b>	
<b>3.200</b>	
mc 0,78 – Kg 80	

CANALETTO



## BASI A TERRA P. 48 CM.

### FLOOR-STANDING BASE UNITS D. 18,89 IN.

2 CASSETTI  
2 DRAWERS

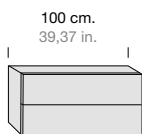

2 CASSETTI  
2 DRAWERS

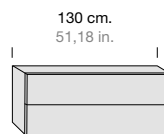

<b>CUC2092K</b>	
	INTERNO E RETRO CANALETTO INTERIOR AND REAR CANALETTO
<b>1.950</b>	
mc 0,43 – Kg 41	

<b>CUC2093K</b>	
<b>2.280</b>	
mc 0,46 – Kg 44	

TECA IN VETRO CON 1 RIPIANO IN VETRO  
GLASS CASE WITH 1 GLASS SHELF

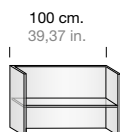

TECA IN VETRO CON 1 RIPIANO IN VETRO  
GLASS CASE WITH 1 GLASS SHELF

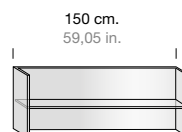

VETRO TRASPARENTE  
TRANSPARENT GLASS

<b>CUC3078K</b>	<b>OPTIONAL</b>	
	VETRO FUMÉ SMOKED GLASS	LUCE LED LED LIGHT
<b>735</b>	<b>+ 50</b>	<b>+ 200</b>
mc 0,32 – Kg 24		

VETRO TRASPARENTE  
TRANSPARENT GLASS

<b>CUC3083K</b>	<b>OPTIONAL</b>	
	VETRO FUMÉ SMOKED GLASS	LUCE LED LED LIGHT
<b>890</b>	<b>+ 50</b>	<b>+ 200</b>
mc 0,45 – Kg 36		

2 ANTE BATTENTI LISCE,  
1 RIPIANO INTERNO IN VETRO  
2 SMOOTH HINGED DOORS,  
1 INNER GLASS SHELF

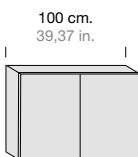

2 ANTE BATTENTI LISCE,  
1 RIPIANO INTERNO IN VETRO  
2 SMOOTH HINGED DOORS,  
1 INNER GLASS SHELF

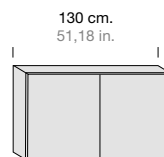

<b>CUC2335K</b>	
<b>1.675</b>	
mc 0,39 – Kg 40	

<b>CUC2336K</b>	
<b>1.700</b>	
mc 0,51 – Kg 44	

1 ANTA BATTENTE CON MANIGLIA,  
1 RIPIANO INTERNO IN VETRO  
1 HINGED DOOR WITH HANDLE,  
1 INNER GLASS SHELF

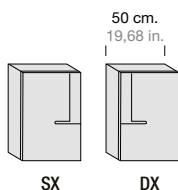

1 ANTA BATTENTE CON MANIGLIA,  
1 RIPIANO INTERNO IN VETRO  
1 HINGED DOOR WITH HANDLE,  
1 INNER GLASS SHELF

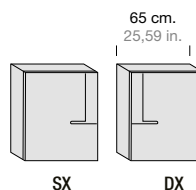

<b>DX - CUC2033K</b>	
<b>SX - CUC2133K</b>	
<b>1.800</b>	
mc 0,19 – Kg 27	

<b>DX - CUC2034K</b>	
<b>SX - CUC2134K</b>	
<b>1.920</b>	
mc 0,25 – Kg 30	

# SISTEMA COMPONIBILE BOOK - BOOK MODULAR SYSTEM

**BASI A TERRA P. 48 CM.**

**FLOOR-STANDING BASE UNITS D. 18,89 IN.**

**BASI H. 80 CM.**

**BASE UNITS H. 31,49 IN.**

2 ANTE BATTENTI CON MANIGLIE,  
1 RIPIANO INTERNO IN VETRO  
2 HINGED DOORS WITH HANDLES,  
1 INNER GLASS SHELF

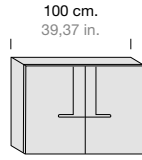

2 ANTE BATTENTI CON MANIGLIE,  
1 RIPIANO INTERNO IN VETRO  
2 HINGED DOORS WITH HANDLES,  
1 INNER GLASS SHELF

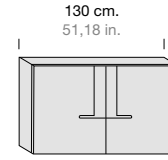

**OBBLIGATORIO: AGGIUNGERE  
PIEDI IN METALLO  
COMPULSORY: ADD METAL FEET.**

<b>CUC2035K</b>	
<b>2.980</b>	
mc 0,39 – Kg 40	

<b>CUC2036K</b>	
<b>3.100</b>	
mc 0,51 – Kg 44	

CANALETTO

4 ANTE BATTENTI CON MANIGLIE,  
2 RIPIANI INTERNI IN VETRO  
4 HINGED DOORS WITH HANDLES,  
2 INNER GLASS SHELVES

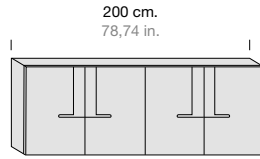

2 ANTE LISCE E 2 ANTE CON MANIGLIA  
2 RIPIANI INTERNI IN VETRO  
2 SMOOTH DOOR AND 2 DOOR WITH  
HANDLES, 2 INTERNAL GLASS SHELVES

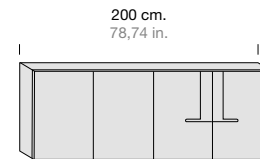

**OBBLIGATORIO: AGGIUNGERE  
PIEDI IN METALLO  
COMPULSORY: ADD METAL FEET.**

<b>CUC2037K</b>	
<b>5.500</b>	
mc 0,78 – Kg 80	

<b>CUC2038K</b>	
<b>4.300</b>	
mc 0,78 – Kg 80	

CANALETTO

3 CASSETTI  
3 DRAWERS



3 CASSETTI  
3 DRAWERS

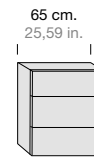

**OBBLIGATORIO: AGGIUNGERE  
PIEDI IN METALLO  
COMPULSORY: ADD METAL FEET.**

<b>CUC2080K</b>	
<b>1.555</b>	
mc 0,19 – Kg 27	

<b>CUC2081K</b>	
<b>1.760</b>	
mc 0,25 – Kg 30	

CANALETTO

TECA IN METALLO CON 2 RIPIANI  
METAL CASE WITH 2 SHELVES

TECA IN METALLO CON 2 RIPIANI  
METAL CASE WITH 2 SHELVES

TECA IN VETRO CON 2 RIPIANI IN VETRO  
GLASS CASE WITH 2 GLASS SHELVES

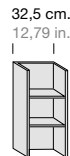

**OBBLIGATORIO: AGGIUNGERE  
PIEDI IN METALLO  
COMPULSORY: ADD METAL FEET.**

<b>CUC4031K</b>	<b>CUC4032K</b>
<b>550</b>	<b>720</b>
mc 0,09 – Kg 7	mc 0,09 – Kg 9

VETRO TRASPARENTE  
TRANSPARENT GLASS

<b>CUC3053K</b>	<b>OPTIONAL</b>	
<b>768</b>	VETRO FUMÉ SMOKED GLASS	LUCE LED LED LIGHT
mc 0,19 – Kg 14	<b>+ 50</b>	<b>+ 200</b>

CANALETTO

1 ANTA LISCIA E 2 ANTE CON MANIGLIA  
2 RIPIANI INTERNI IN VETRO  
1 SMOOTH DOOR AND 2 DOOR WITH  
HANDLES, 2 INTERNAL GLASS SHELVES

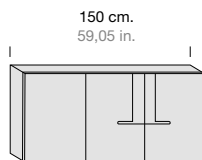

<b>CUC2135K</b>	
<b>3.650</b>	
mc 0,78 – Kg 80	

1 ANTA LISCIA E 2 ANTE CON MANIGLIA  
2 RIPIANI INTERNI IN VETRO  
1 SMOOTH DOOR AND 2 DOOR WITH  
HANDLES, 2 INTERNAL GLASS SHELVES

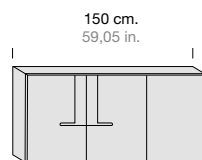

<b>CUC2136K</b>	
<b>3.650</b>	
mc 0,78 – Kg 80	

2 ANTE LISCE E 2 ANTE CON MANIGLIA  
2 RIPIANI INTERNI IN VETRO  
2 SMOOTH DOOR AND 2 DOOR WITH  
HANDLES, 2 INTERNAL GLASS SHELVES

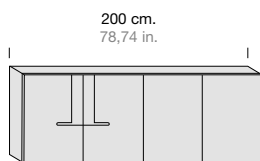

<b>CUC2039K</b>	
<b>4.300</b>	
mc 0,78 – Kg 80	

3 CASSETTI  
3 DRAWERS

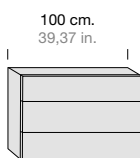

<b>CUC2082K</b>	
<b>2.280</b>	
mc 0,39 – Kg 40	

3 CASSETTI  
3 DRAWERS

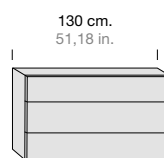

<b>CUC2083K</b>	
<b>2.620</b>	
mc 0,51 – Kg 44	

TECA IN VETRO CON 2 RIPIANI IN VETRO  
GLASS CASE WITH 2 GLASS SHELVES

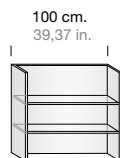

VETRO TRASPARENTE  
TRANSPARENT GLASS

<b>CUC3058K</b>	<b>OPTIONAL</b>	
	VETRO FUMÉ SMOKED GLASS	LUCE LED LED LIGHT
<b>816</b>	<b>+ 50</b>	<b>+ 200</b>
mc 0,38 – Kg 28		

TECA IN VETRO CON 2 RIPIANI IN VETRO  
GLASS CASE WITH 2 GLASS SHELVES

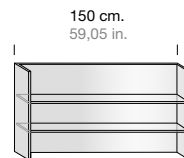

VETRO TRASPARENTE  
TRANSPARENT GLASS

<b>CUC3063K</b>	<b>OPTIONAL</b>	
	VETRO FUMÉ SMOKED GLASS	LUCE LED LED LIGHT
<b>975</b>	<b>+ 50</b>	<b>+ 200</b>
mc 0,58 – Kg 42		

# SISTEMA COMPONIBILE BOOK - BOOK MODULAR SYSTEM

## COMPOSIZIONI COMPOSITIONS

### COMPOSIZIONE 100 COMPOSITION 100

1	<b>CUC2025K</b>	BASE 2 ANTE CON MANIGLIE BASE WITH 2 DOORS WITH HANDLES	2.500
1	<b>CUC2323K</b>	BASE 1 ANTA LISCIA BASE WITH 1 SMOOTH DOOR	1.050
1	<b>CUC3038K</b>	TECA IN VETRO FUMÉ CON 1 RIPIANO SMOKED GLASS CASE WITH 1 GLASS SHELF	705
1	<b>CUC1204K</b>	TOP IN LEGNO WOODEN TOP	780
1	<b>CUC1004K</b>	BASE IN LEGNO WOODEN BASE	780
1	<b>CUC9101K</b>	COPPIA DI PIEDI IN VETRO FUMÉ COUPLE OF SMOKED GLASS FEETS	400
<b>PREZZO TOT. COMPOSIZIONE</b> TOTAL PRICE FOR COMPOSITION			<b>6.215</b>

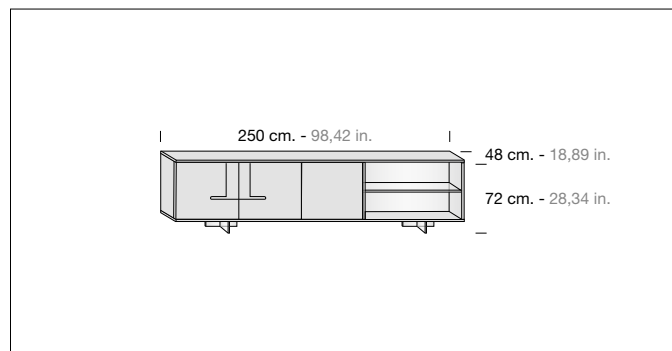

### COMPOSIZIONE 105 COMPOSITION 105

1	<b>CUC2035K</b>	BASE 2 ANTE CON MANIGLIE BASE WITH 2 DOORS WITH HANDLES	2.980
1	<b>CUC2334K</b>	BASE 1 ANTA LISCIA BASE WITH 1 SMOOTH DOOR	1.320
1	<b>CUC4032K</b>	TECA IN METALLO METAL CASE	720
1	<b>CUC1103K</b>	TOP IN LEGNO WOODEN TOP	390
1	<b>CUC1003K</b>	BASE IN LEGNO WOODEN BASE	600
1	<b>CUC9001K</b>	COPPIA DI PIEDI IN METALLO COUPLE OF METAL FEETS	350
<b>PREZZO TOT. COMPOSIZIONE</b> TOTAL PRICE FOR COMPOSITION			<b>6.360</b>

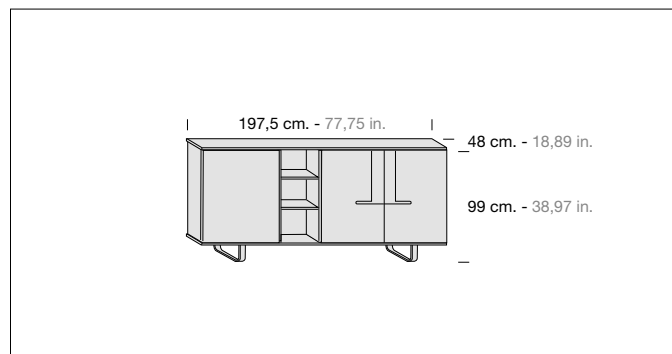

### COMPOSIZIONE 110 COMPOSITION 110

1	<b>CUC2028K</b>	BASE 2 ANTE CON MANIGLIE, 2 ANTE LISCE BASE WITH 2 DOORS WITH HANDLES AND 2 SMOOTH DOORS	3.400
1	<b>CUC1118K</b>	TOP IN LEGNO SAGOMATO SHAPED WOODEN TOP	500
1	<b>CUC1018K</b>	BASE IN LEGNO SAGOMATA SHAPED WOODEN BASE	760
1	<b>CUC9001K</b>	COPPIA DI PIEDI IN METALLO COUPLE OF METAL FEETS	350
2	<b>CUC7021K</b>	FIANCO SAGOMATO SHAPED SIDE	560
<b>PREZZO TOT. COMPOSIZIONE</b> TOTAL PRICE FOR COMPOSITION			<b>5.570</b>

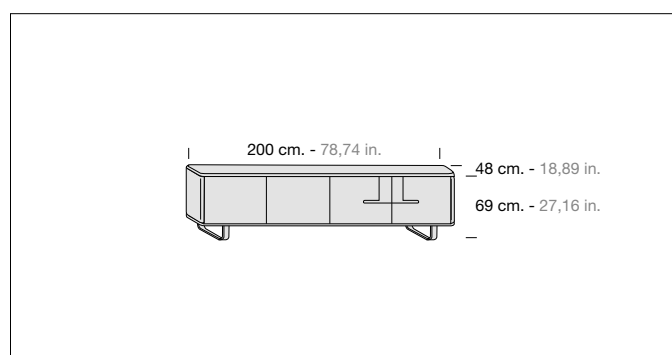

## COMPOSIZIONI COMPOSITIONS

### COMPOSIZIONE 120 COMPOSITION 120

1	<b>CUC2027K</b>	BASE 4 ANTE CON MANIGLIE BASE WITH 4 DOORS WITH HANDLES	<b>4.800</b>
1	<b>CUC1318K</b>	TOP IN MARMO SAGOMATO SHAPED MARBLE TOP	<b>1.910</b>
1	<b>CUC1018K</b>	BASE IN LEGNO SAGOMATA SHAPED WOODEN BASE	<b>760</b>
1	<b>CUC9001K</b>	COPPIA DI PIEDI IN METALLO COUPLE OF METAL FEET	<b>350</b>
2	<b>CUC7011K</b>	FIANCO SAGOMATO SHAPED SIDE	<b>500</b>
<b>PREZZO TOT. COMPOSIZIONE</b> TOTAL PRICE FOR COMPOSITION			<b>8.320</b>

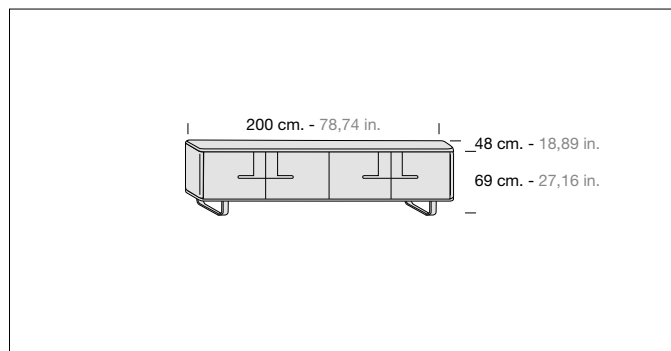

### COMPOSIZIONE 125 COMPOSITION 125

1	<b>CUC2315K</b>	BASE 2 ANTE LISCE BASE WITH 2 SMOOTH DOORS	<b>1.300</b>
1	<b>CUC2063K</b>	BASE 2 CASSETTI BASE WITH 2 DRAWERS	<b>1.785</b>
1	<b>CUC4012K</b>	TECA IN METALLO METAL CASE	<b>395</b>
1	<b>CUC1105K</b>	TOP IN LEGNO WOODEN TOP	<b>500</b>
1	<b>CUC1005K</b>	BASE IN LEGNO WOODEN BASE	<b>800</b>
1	<b>CUC9001K</b>	COPPIA DI PIEDI IN METALLO COUPLE OF METAL FEET	<b>350</b>
<b>PREZZO TOT. COMPOSIZIONE</b> TOTAL PRICE FOR COMPOSITION			<b>5.130</b>

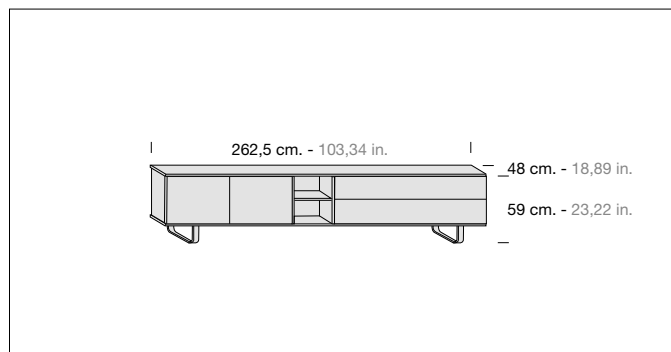

### COMPOSIZIONE 130 COMPOSITION 130

1	<b>CUC2015K</b>	BASE 2 ANTE CON MANIGLIE BASE WITH 2 DOORS WITH HANDLES	<b>2.200</b>
1	<b>CUC2414K</b>	BASE 1 ANTA LISCIA BASE WITH 1 SMOOTH DOOR	<b>1.000</b>
1	<b>CUC1118K</b>	TOP IN LEGNO SAGOMATO SHAPED WOODEN TOP	<b>500</b>
1	<b>CUC1018K</b>	BASE IN LEGNO SAGOMATA SHAPED WOODEN BASE	<b>760</b>
2	<b>CUC9001K</b>	COPPIA DI PIEDI IN METALLO COUPLE OF METAL FEET	<b>350</b>
2	<b>CUC7011K</b>	FIANCO SAGOMATO SHAPED SIDE	<b>500</b>
2	<b>CUC4012K</b>	TECA IN METALLO METAL CASE	<b>395</b>
<b>PREZZO TOT. COMPOSIZIONE</b> TOTAL PRICE FOR COMPOSITION			<b>5.705</b>

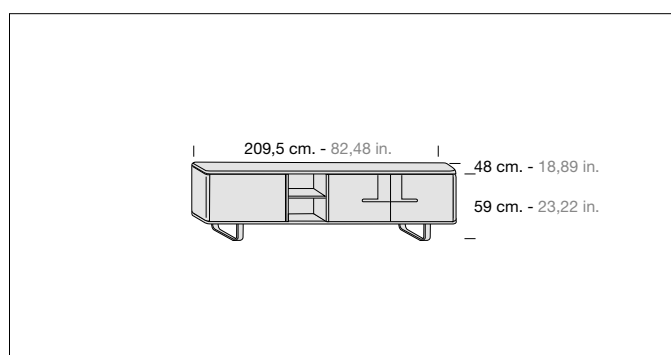

# SISTEMA COMPONIBILE BOOK - BOOK MODULAR SYSTEM

## COMPOSIZIONI COMPOSITIONS

### COMPOSIZIONE 135 COMPOSITION 135

1	<b>CUC2025K</b>	BASE 2 ANTE CON MANIGLIE BASE WITH 2 DOORS WITH HANDLES	2.500
1	<b>CUC2326K</b>	BASE 2 ANTE LISCE BASE WITH 2 SMOOTH DOORS	1.500
1	<b>CUC4022K</b>	TECA IN METALLO METAL GLASS CASE	435
1	<b>CUC1105K</b>	TOP IN LEGNO WOODEN TOP	500
1	<b>CUC1005K</b>	BASE IN LEGNO WOODEN BASE	800
1	<b>CUC9001K</b>	COPPIA DI PIEDI IN METALLO COUPLE OF METAL FEETS	350
<b>PREZZO TOT. COMPOSIZIONE</b> TOTAL PRICE FOR COMPOSITION			<b>6.085</b>

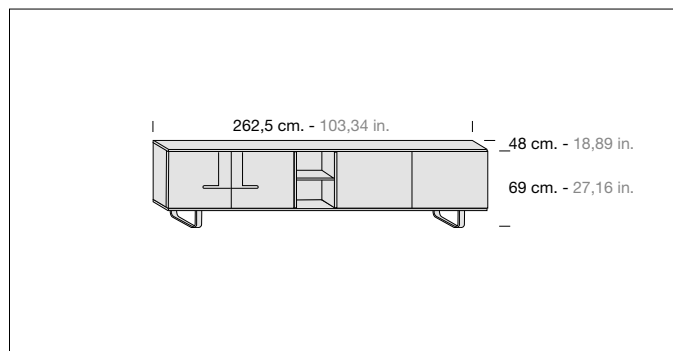

### COMPOSIZIONE 140 COMPOSITION 140

1	<b>CUC2335K</b>	BASE 2 ANTE LISCE BASE WITH 2 SMOOTH DOORS	1.675
1	<b>CUC2081K</b>	BASE 3 CASSETTI BASE WITH 3 DRAWERS	1.760
1	<b>CUC4032K</b>	TECA IN METALLO METAL CASE	720
1	<b>CUC1218K</b>	TOP IN LEGNO SAGOMATO SHAPED WOODEN TOP	760
1	<b>CUC1018K</b>	BASE IN LEGNO SAGOMATA SHAPED WOODEN BASE	760
1	<b>CUC9001K</b>	COPPIA DI PIEDI IN METALLO COUPLE OF METAL FEETS	350
2	<b>CUC7031K</b>	FIANCO SAGOMATO SHAPED SIDE	600
<b>PREZZO TOT. COMPOSIZIONE</b> TOTAL PRICE FOR COMPOSITION			<b>6.625</b>

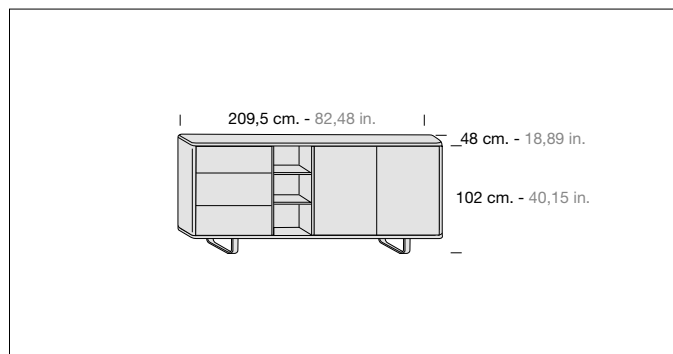

### COMPOSIZIONE 145 COMPOSITION 145

1	<b>CUC2019K</b>	BASE 2 ANTE CON MANIGLIE E 2 ANTE LISCE BASE WITH 2 DOORS WITH HANDLES AND 2 SMOOTH DOORS	3.200
1	<b>CUC3018K</b>	TECA IN VETRO TRASPARENTE CON 1 RIPIANO TRANSPARENT GLASS CASE WITH 1 GLASS SHELF	610
1	<b>CUC1105K</b>	TOP IN LEGNO WOODEN TOP	500
1	<b>CUC1005K</b>	BASE IN LEGNO WOODEN BASE	800
1	<b>CUC9101K</b>	COPPIA DI PIEDI IN VETRO TRASPARENTE COUPLE OF TRANSPARENT GLASS FEETS	400
<b>PREZZO TOT. COMPOSIZIONE</b> TOTAL PRICE FOR COMPOSITION			<b>5.510</b>

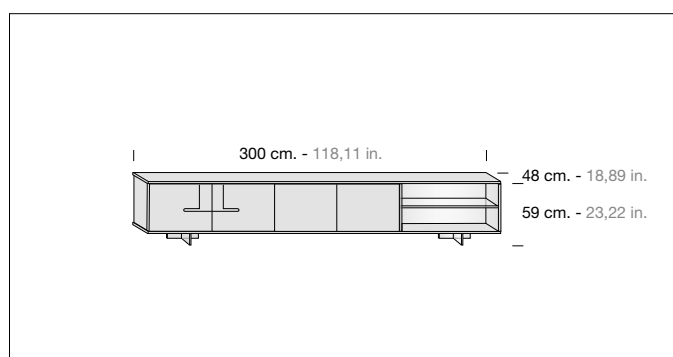

## COMPOSIZIONI COMPOSITIONS

### COMPOSIZIONE 150 COMPOSITION 150

1	<b>CUC2317K</b>	BASE 4 ANTE LISCE BASE WITH 4 SMOOTH DOORS	2.500
1	<b>CUC3018K</b>	TECA IN VETRO TRASPARENTE CON 1 RIPIANO TRANSPARENT GLASS CASE WITH 1 GLASS SHELF	610
1	<b>CUC1205K</b>	TOP IN LEGNO WOODEN TOP	800
1	<b>CUC1005K</b>	BASE IN LEGNO WOODEN BASE	800
1	<b>CUC9101K</b>	COPPIA DI PIEDI IN VETRO TRASPARENTE COUPLE OF TRANSPARENT GLASS FEET	400
<b>PREZZO TOT. COMPOSIZIONE</b> TOTAL PRICE FOR COMPOSITION			<b>5.110</b>

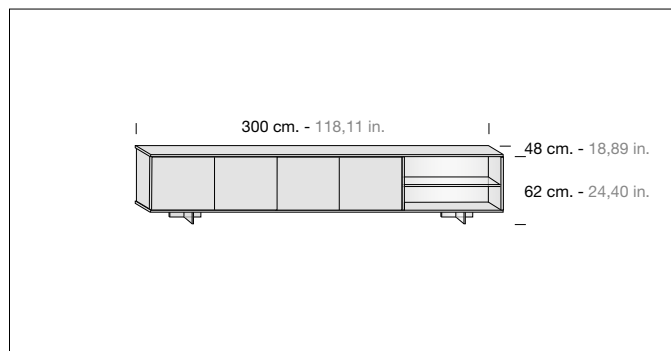

### COMPOSIZIONE 155 COMPOSITION 155

1	<b>CUC2315K</b>	BASE 2 ANTE LISCE BASE WITH 2 SMOOTH DOORS	1.300
1	<b>CUC3018K</b>	TECA IN VETRO FUMÉ CON 1 RIPIANO SMOKED GLASS CASE WITH 1 GLASS SHELF	660
1	<b>CUC1103K</b>	TOP IN LEGNO WOODEN TOP	390
1	<b>CUC1003K</b>	BASE IN LEGNO WOODEN BASE	600
1	<b>CUC9101K</b>	COPPIA DI PIEDI IN VETRO FUMÉ COUPLE OF SMOKED GLASS FEET	400
<b>PREZZO TOT. COMPOSIZIONE</b> TOTAL PRICE FOR COMPOSITION			<b>3.350</b>

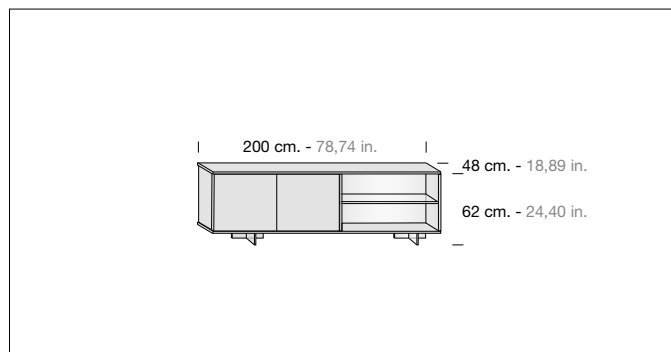

### COMPOSIZIONE 160 COMPOSITION 160

1	<b>CUC2434K</b>	BASE 1 ANTA LISCIA BASE WITH 1 SMOOTH DOOR	1.320
1	<b>CUC2081K</b>	BASE 3 CASSETTI BASE WITH 3 DRAWERS	1.760
1	<b>CUC3058K</b>	TECA IN VETRO FUMÉ CON 2 RIPIANI SMOKED GLASS CASE WITH 2 SHELVES	866
1	<b>CUC1104K</b>	TOP IN LEGNO WOODEN TOP	450
1	<b>CUC1004K</b>	BASE IN LEGNO WOODEN BASE	780
1	<b>CUC9101K</b>	COPPIA DI PIEDI IN VETRO FUMÉ COUPLE OF SMOKED GLASS FEET	400
<b>PREZZO TOT. COMPOSIZIONE</b> TOTAL PRICE FOR COMPOSITION			<b>5.576</b>

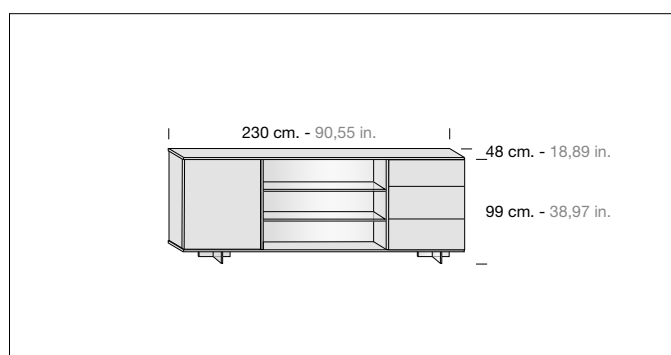





**03** \_ GIORNO E NOTTE  
DAY AND NIGHT

**107** \_ SISTEMA COMPONIBILE BOOK  
BOOK MODULAR SYSTEM

**127** \_ SISTEMA COMPONIBILE DOMINO  
DOMINO MODULAR SYSTEM

**179** \_ DIVANO COMPONIBILE PENTA  
PENTA MODULAR SOFA

- 128** CARATTERISTICHE TECNICHE E PARTICOLARITÀ DI UTILIZZO  
TECHNICAL CHARACTERISTICS AND PARTICULAR USE
- 137** ACCESSORI OPTIONAL  
OPTIONAL ACCESSORIES
- 138** ELEMENTI STRUTTURALI  
STRUCTURAL ELEMENTS
- 142** BASI A TERRA P. 38  
FLOOR-STANDING BASE UNITS D. 38
- 144** BASI A TERRA P. 48  
FLOOR-STANDING BASE UNITS D. 48
- 148** BASI SOSPESE P. 38  
SUSPENDED BASE UNITS D. 38
- 150** BASI SOSPESE P. 48  
SUSPENDED BASE UNITS D. 48
- 154** PENSILI ORIZZONTALI P. 38  
HORIZONTAL WALL UNITS D. 38
- 160** PENSILI VERTICALI P. 38  
VERTICAL WALL UNITS D. 38
- 164** COLONNE A GIORNO P. 30  
RAISED TALL UNITS P. 30
- 166** COMPOSIZIONI A CATALOGO  
CATALOGUE COMPOSITIONS

# SISTEMA COMPONIBILE - MODULAR SYSTEM

## CARATTERISTICHE TECNICHE E PARTICOLARITÀ DI UTILIZZO

### TECHNICAL CHARACTERISTICS AND PARTICULAR USE

#### BASI BASE UNITS

##### FRONTALI FRONTS

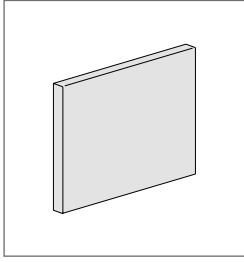

ANTA LEGNO LISCIA  
PLAIN WOODEN DOOR

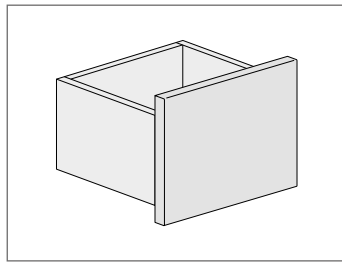

FRONTALE LEGNO LISCIO  
PLAIN WOODEN FRONT

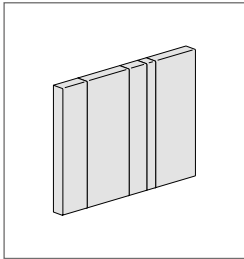

DOGA LEGNO LISCIA  
PLAIN WOODEN SLAT

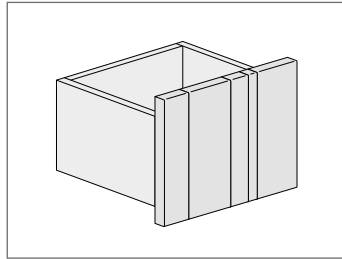

DOGA LEGNO LISCIA  
PLAIN WOODEN SLAT

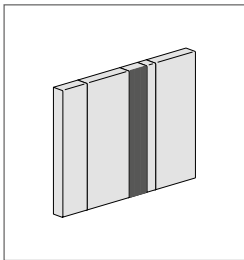

DOGA RIGHE  
STRIPED SLAT

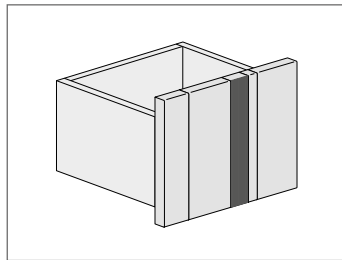

DOGA RIGHE  
STRIPED SLAT

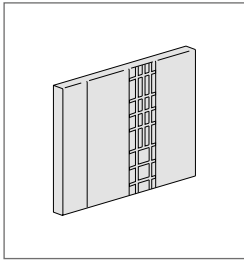

DOGA QUADRO LEGNO  
WOODEN SQUARE SLAT

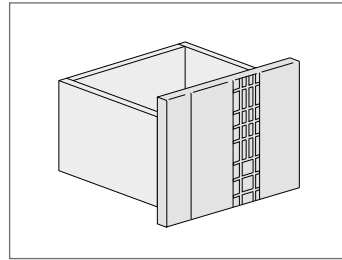

DOGA QUADRO LEGNO  
WOODEN SQUARE SLAT

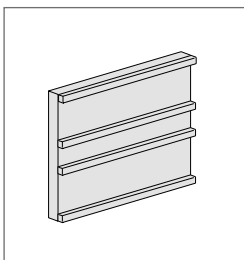

ANTA LEGNO SHANGHAI  
SHANGHAI WOODEN DOOR

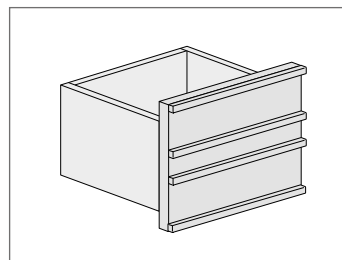

FRONTALE LEGNO SHANGHAI  
SHANGHAI WOODEN FRONT

**STRUTTURA** PANNELLO DI LISTELLARE ESTERNO RIVESTITO IN NOCE CANALETTO, INTERNO ANTA LEGNO, ANTA VETRO E CESTONI RIVESTITO IN NOCE TANGANICA, INTERNO MODULI A GIORNO RIVESTITO IN NOCE CANALETTO

**TOP OBBLIGATORIO** PANNELLO DI LEGNO MULTISTRATI IMPIALLACCIATO NOCE CANALETTO SP. 1.1

**FRONTALE LEGNO PANNELLO LISCIO** PANNELLO DI LISTELLARE IMPIALLACCIATA INTERNAMENTE IN NOCE CANALETTO ED ESTERNAMENTE IN NOCE CANALETTO SP. 3 CM

**FRONTALE LEGNO A DOGHE** PANNELLO DI LISTELLARE IMPIALLACCIATA INTERNAMENTE IN NOCE CANALETTO ED ESTERNAMENTE IN NOCE TANGANICA SP. 2.9 CM, CON DOGHE IN MULTISTRATI IMPIALLACCIATO NOCE CANALETTO E LATI IN MASSELLO DI NOCE CANALETTO SP. 0.3 CM

**SCHIENALE** INTERNO ANTE LEGNO E VETRO IN MULTISTRATI NOCE TANGANICA SPESSORE 0.8 CM

**ZOCCOLO** PANNELLO DI LISTELLARE IMPIALLACCIATO IN NOCE CANALETTO E RETRO IN NOCE TANGANICA SPESSORE 4 CM.

**PEDANA** PANNELLO DI LISTELLARE IMPIALLACCIATO IN NOCE CANALETTO E RETRO IN NOCE TANGANICA SPESSORE 4 CM – PIEDINI IN PANNELLO NOCE CANALETTO 2 FACCE SPESSORE 4 CM.

**RIPIANI INTERNI** VETRO SP. 0.8

**ELEMENTI A GIORNO** PANNELLO DI LISTELLARE IMPIALLACCIATA INTERNAMENTE ED ESTERNAMENTE IN NOCE CANALETTO SPESSORE 1.8 CM

**SCHIENALE ELEMENTI A GIORNO** PANNELLO DI MULTISTRATI DI NOCE CANALETTO SPESSORE 0.8 CM

**STRUCTURE** BLOCKBOARD PANEL: OUTSIDE COVERED IN CANALETTO WALNUT, INSIDE OF WOODEN DOOR, GLASS DOOR AND BASKETS COVERED IN TANGANICA WALNUT, INSIDE OF OPEN MODULES COVERED IN CANALETTO WALNUT

**COMPUSLORY TOP** MULTILAYER WOODEN PANEL VENEERED IN CANALETTO WALNUT TH. 1.1

**PLAIN PANEL WOODEN FRONT** BLOCKBOARD PANEL: INSIDE VENEERED IN CANALETTO WALNUT AND OUTSIDE IN CANALETTO WALNUT TH. 3 CM

**SLATTED WOODEN FRONT** BLOCKBOARD PANEL: INSIDE VENEERED IN CANALETTO WALNUT AND OUTSIDE IN TANGANICA WALNUT TH. 2.9 CM, WITH MULTILAYER SLAT VENEERED IN CANALETTO WALNUT AND SIDES IN SOLID CANALETTO WALNUT TH. 0.3 CM

**BACK PANEL** INSIDE OF WOODEN AND GLASS DOORS IN MULTILAYER TANGANICA WALNUT TH. 0.8 CM

**PLINTH** BLOCKBOARD PANEL: VENEERED IN CANALETTO WALNUT AND BACK IN TANGANICA WALNUT TH. 4 CM

BLOCKBOARD PANEL: VENEERED IN CANALETTO WALNUT AND BACK IN TANGANICA WALNUT TH. 4 CM – FEET IN CANALETTO WALNUT PANEL 2 SIDES TH. 4 CM.

**INTERNAL SHELVES** GLASS TH. 0.8

**OPEN ELEMENTS** BLOCKBOARD PANEL: INSIDE VENEERED AND OUTSIDE IN CANALETTO WALNUT TH. 1.8 CM

**BACK PANEL FOR OPEN ELEMENT** MULTILAYER PANEL IN CANALETTO WALNUT TH. 0.8 CM

##### MANIGLIE HANDLES

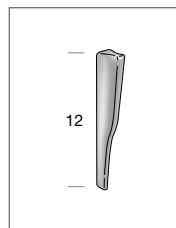

MANIGLIA PICCOLA  
SMALL HANDLE

## CARATTERISTICHE TECNICHE E PARTICOLARITÀ DI UTILIZZO TECHNICAL CHARACTERISTICS AND PARTICULAR USE

### PENSILI WALL UNITS

#### FRONTALI FRONTS

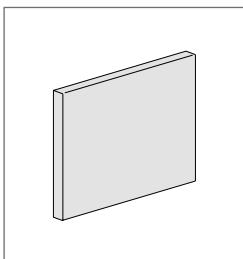

ANTA LEGNO LISCIA  
PLAIN WOODEN DOOR

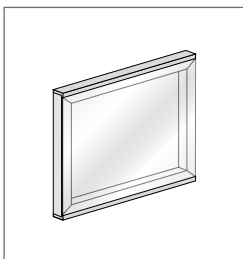

ANTA VETRO  
GLASS DOOR

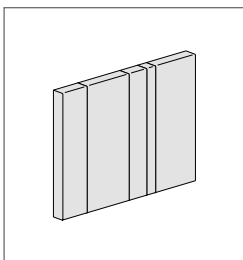

DOGA LEGNO LISCIA  
PLAIN WOODEN SLAT

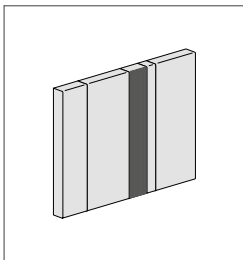

DOGA RIGHE  
STRIPED SLAT

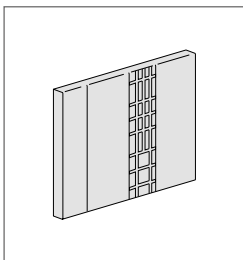

DOGA QUADRO LEGNO  
WOODEN SQUARE SLAT

**STRUTTURA** PANNELLO DI LISTELLARE ESTERNO RIVESTITO IN NOCE CANALETTO, INTERNO ANTA LEGNO, ANTA VETRO E CESTONI RIVESTITO IN NOCE TANGANICA, INTERNO MODULI A GIORNO RIVESTITO IN NOCE CANALETTO

**TOP OPZIONALE** PANNELLO DI LEGNO MULTISTRATI IMPIALLACCIATO NOCE CANALETTO SP. 1.3

**FRONTALE LEGNO PANNELLO LISCIO** PANNELLO DI LISTELLARE IMPIALLACCIATA INTERNAMENTE IN NOCE CANALETTO ED ESTERNAMENTE IN NOCE CANALETTO SP. 3 CM

**FRONTALE LEGNO A DOGHE** PANNELLO DI LISTELLARE IMPIALLACCIATA INTERNAMENTE IN NOCE CANALETTO ED ESTERNAMENTE IN NOCE TANGANICA SP. 2.9 CM, CON DOGHE IN MULTISTRATI IMPIALLACCIATO NOCE CANALETTO E LATI IN MASSELLO DI NOCE CANALETTO SP. 0.3 CM

**FRONTALE VETRO** TELAIO IN PANNELLO DI LISTELLARE IMPIALLACCIATA INTERNAMENTE IN NOCE CANALETTO ED ESTERNAMENTE IN NOCE CANALETTO, PROFILO SUPERIORE E INFERIORE IN MASSELLO DI NOCE CANALETTO 5X2.5 CM

**SCHIENALE** INTERNO ANTE LEGNO E VETRO IN MULTISTRATI NOCE TANGANICA SPESSORE 0.8 CM

**RIPIANI INTERNI** VETRO SP. 0.8

**ELEMENTI A GIORNO** PANNELLO DI LISTELLARE IMPIALLACCIATA INTERNAMENTE ED ESTERNAMENTE IN NOCE CANALETTO SPESSORE 1.8 CM

**SCHIENALE ELEMENTI A GIORNO** PANNELLO DI MULTISTRATI DI NOCE CANALETTO SPESSORE 0.8 CM

**STRUCTURE** BLOCKBOARD PANEL: OUTSIDE COVERED IN CANALETTO WALNUT, INSIDE OF WOODEN DOOR, GLASS DOOR AND BASKETS COVERED IN TANGANICA WALNUT, INSIDE OF OPEN MODULES COVERED IN CANALETTO WALNUT

**OPTIONAL TOP** MULTILAYER WOODEN PANEL VENEERED IN CANALETTO WALNUT TH. 1.3

**PLAIN PANEL WOODEN FRONT** BLOCKBOARD PANEL: INSIDE VENEERED IN CANALETTO WALNUT AND OUTSIDE IN CANALETTO WALNUT TH. 3 CM

**SLATTED WOODEN FRONT** BLOCKBOARD PANEL: INSIDE VENEERED IN CANALETTO WALNUT AND OUTSIDE IN TANGANICA WALNUT TH. 2.9 CM, WITH MULTILAYER SLAT VENEERED IN CANALETTO WALNUT AND SIDES IN SOLID CANALETTO WALNUT TH. 0.3 CM

**GLASS FRONT** FRAME IN BLOCKBOARD PANEL VENEERED INSIDE IN CANALETTO WALNUT AND OUTSIDE IN CANALETTO WALNUT, TOP AND LOW PROFILE IN WALNUT SOLID WOOD 5X2.5 CM

**BACK PANEL** INSIDE OF WOODEN AND GLASS DOORS IN MULTILAYER TANGANICA WALNUT TH. 0.8 CM

**INTERNAL SHELVES** GLASS TH. 0.8

**OPEN ELEMENTS** BLOCKBOARD PANEL: INSIDE VENEERED AND OUTSIDE IN CANALETTO WALNUT TH. 1.8 CM

**BACK PANEL FOR OPEN ELEMENT** MULTILAYER PANEL IN CANALETTO WALNUT TH. 0.8 CM

#### MANIGLIE HANDLES

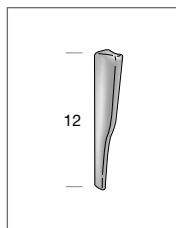

MANIGLIA PICCOLA  
SMALL HANDLE

# SISTEMA COMPONIBILE - MODULAR SYSTEM

ESEMPIO DI BASI A TERRA CON ZOCCOLO E PENSILI FISSATI A PARETE

EXAMPLE OF FLOOR-STANDING WITH PLINTH AND WALL UNITS FIXED TO THE WALL

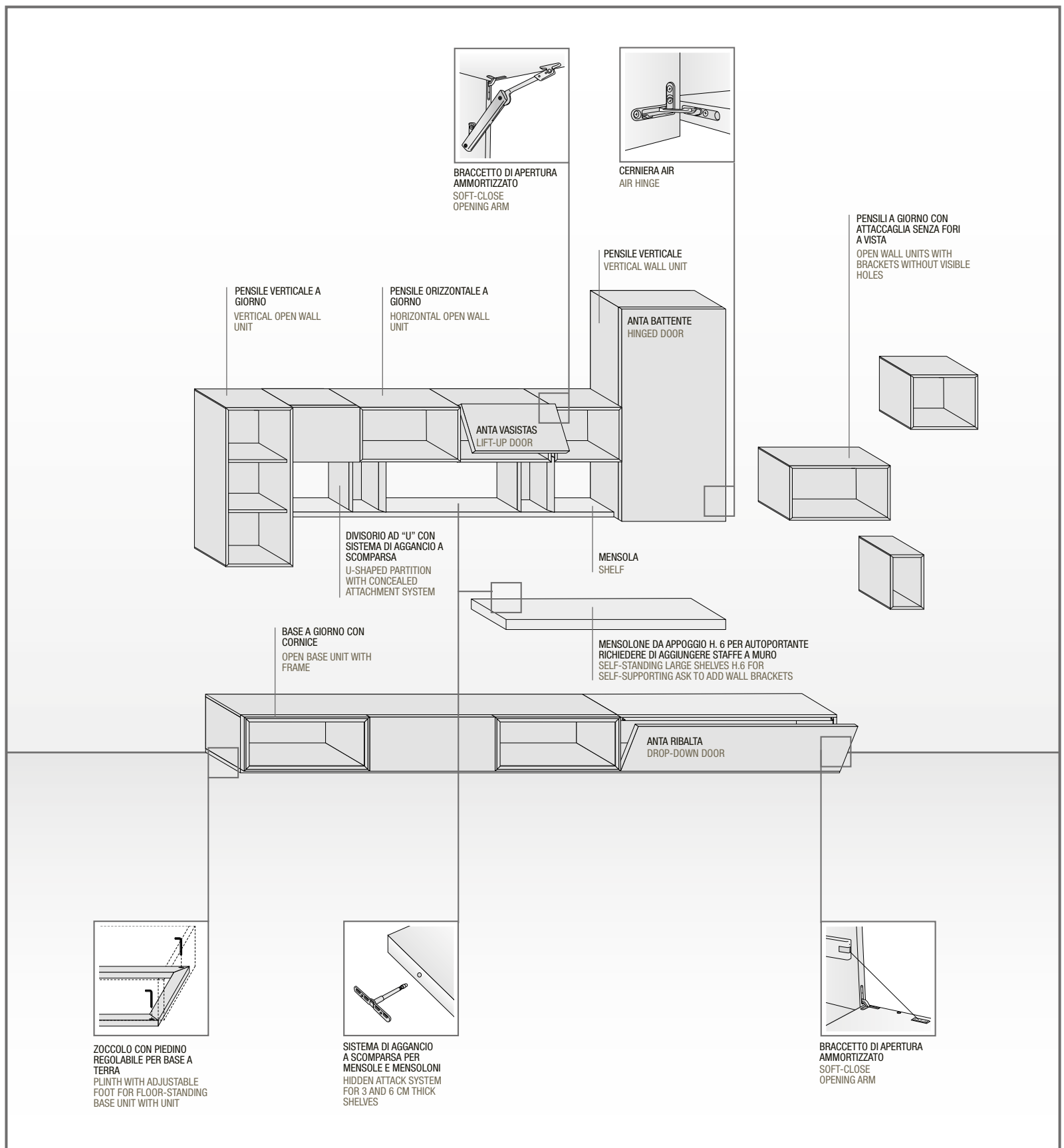

## FRONTALI DOMINO DOMINO FRONTS

### ANTE DOORS

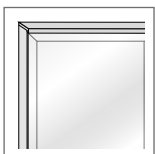

**VETRO**  
(BATTENTE/VASISTAS/  
RIBALTA)  
GLASS  
(HINGED/LIFT-UP/DROP-  
DOWN)

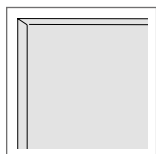

**LEGNO**  
(BATTENTE/VASISTAS/  
RIBALTA)  
WOOD  
(HINGED/LIFT-UP/DROP-  
DOWN)

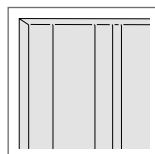

**LEGNO DOGA LEGNO LISCIA**  
(BATTENTE/VASISTAS/  
RIBALTA)  
WOOD, PLAIN WOODEN SLAT  
(HINGED/LIFT-UP/DROP-  
DOWN)

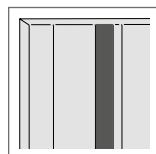

**LEGNO DOGA RIGHE**  
(BATTENTE/VASISTAS/  
RIBALTA)  
STRIPED WOODEN SLAT  
(HINGED/LIFT-UP/DROP-  
DOWN)

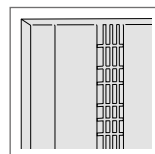

**LEGNO DOGA QUADRO LEGNO**  
(BATTENTE/VASISTAS/  
RIBALTA)  
WOOD, WOODEN SQUARE SLAT  
(HINGED/LIFT-UP/DROP-  
DOWN)

# SISTEMA COMPONIBILE - MODULAR SYSTEM

ESEMPIO DI BASI A TERRA SU PEDANA E PENSILI IN APPOGGIO (COMPOSIZIONE AUTOPORTANTE)

EXAMPLE OF FLOOR-STANDING BASE UNITS ON PLATFORM AND RAISED WALL UNITS (SELF-SUPPORTING COMPOSITION)

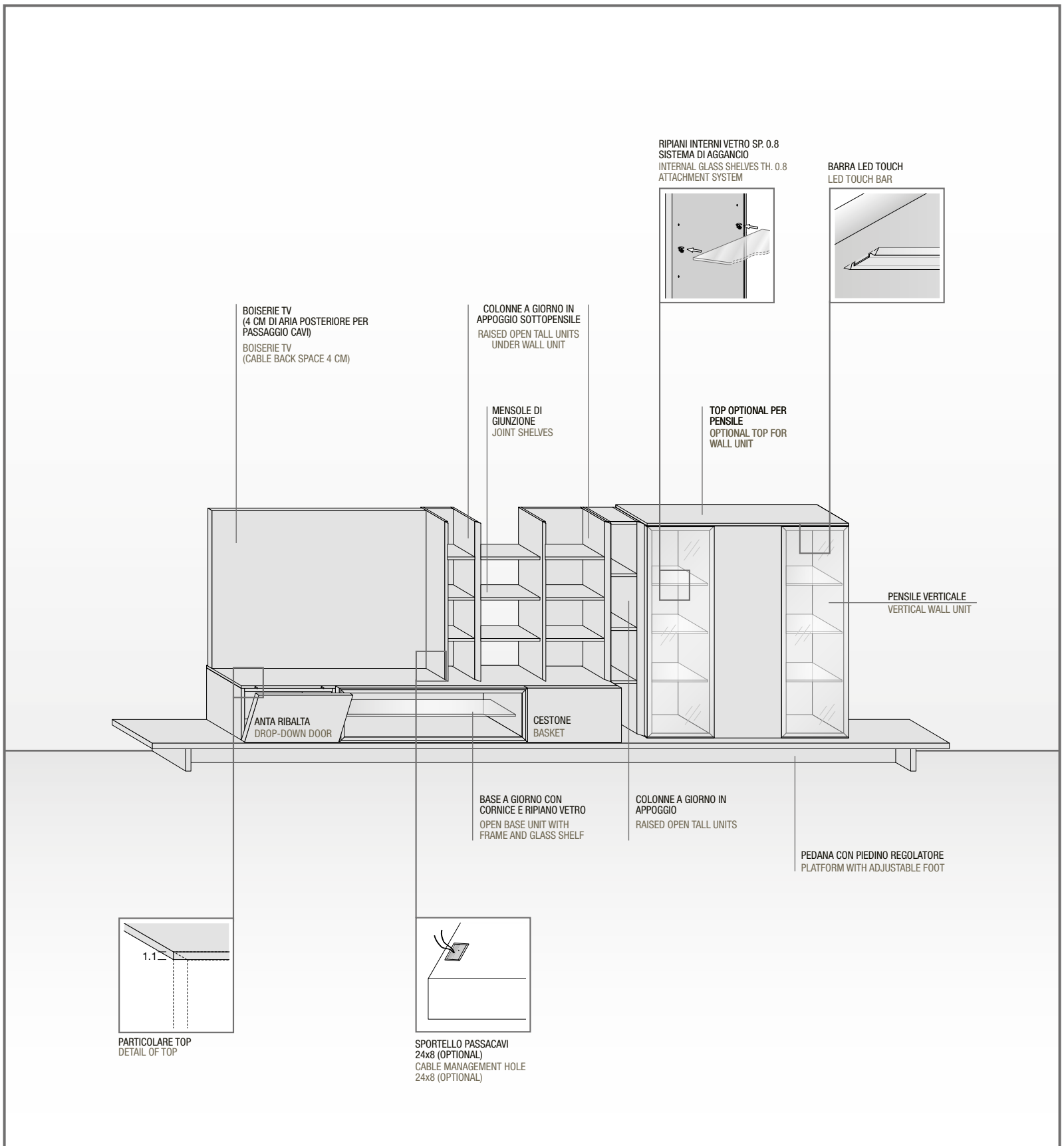

## CESTONI BASKETS

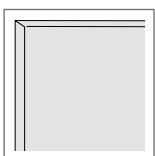

LEGNO  
WOOD

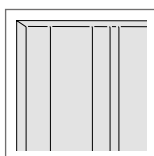

LEGNO DOGA LEGNO  
LISCIA  
WOOD, PLAIN WOODEN  
SLAT

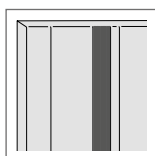

LEGNO DOGA RIGHE  
WOOD, STRIPED SLAT

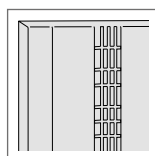

LEGNO DOGA QUADRO  
LEGNO  
WOOD, WOODEN  
SQUARE SLAT

# SISTEMA COMPONIBILE - MODULAR SYSTEM

## MODULARITÀ

## MODULARITY

### BASI A TERRA H. 35 CM. – P. 38/48 CM. FLOOR-STANDING BASE UNIT H. 13,77 IN. – D. 14,96/18,89 IN.

A GIORNO SU ZOCCOLO  
OPEN ON PLINTH

40 cm. 60 cm. 80 cm. 120 cm. 140 cm.  
15,74 in. 23,62 in. 31,49 in. 47,24 in. 55,11 in.

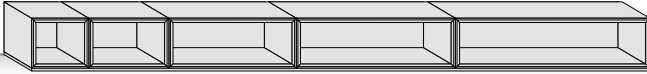

A GIORNO SU PEDANA  
OPEN ON PLATFORM

40 cm. 60 cm. 80 cm. 120 cm. 140 cm.  
15,74 in. 23,62 in. 31,49 in. 47,24 in. 55,11 in.

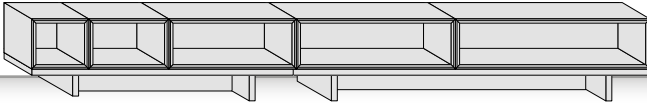

CON CESTONE SU ZOCCOLO  
WITH BASKET ON PLINTH

40 cm. 60 cm. 80 cm. 120 cm. 140 cm.  
15,74 in. 23,62 in. 31,49 in. 47,24 in. 55,11 in.

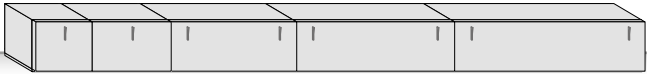

CON CESTONE SU PEDANA  
WITH BASKET ON PLATFORM

40 cm. 60 cm. 80 cm. 120 cm. 140 cm.  
15,74 in. 23,62 in. 31,49 in. 47,24 in. 55,11 in.

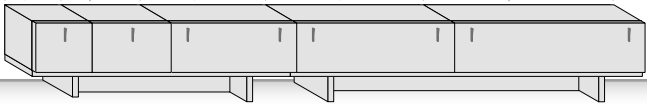

CON ANTA A RIBALTA SU ZOCCOLO  
WITH DROP-DOWN DOOR ON PLINTH

40 cm. 60 cm. 80 cm. 120 cm. 140 cm.  
15,74 in. 23,62 in. 31,49 in. 47,24 in. 55,11 in.

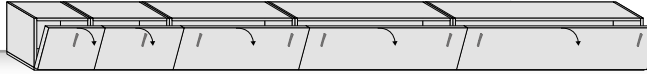

CON ANTA A RIBALTA SU PEDANA  
WITH DROP-DOWN DOOR ON PLATFORM

40 cm. 60 cm. 80 cm. 120 cm. 140 cm.  
15,74 in. 23,62 in. 31,49 in. 47,24 in. 55,11 in.

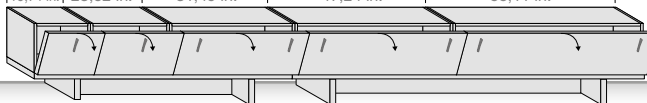

### BASI SOSPESSE H. 35 CM. – P. 38/48 CM. SUSPENDED BASE UNITS H. 13,77 IN. – D. 14,96/18,89 IN.

A GIORNO  
OPEN

40 cm. 60 cm. 80 cm. 120 cm. 140 cm.  
15,74 in. 23,62 in. 31,49 in. 47,24 in. 55,11 in.

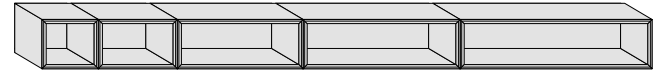

CON CESTONE  
WITH BASKET

40 cm. 60 cm. 80 cm. 120 cm. 140 cm.  
15,74 in. 23,62 in. 31,49 in. 47,24 in. 55,11 in.



CON ANTA A RIBALTA  
WITH DROP-DOWN DOOR

40 cm. 60 cm. 80 cm. 120 cm. 140 cm.  
15,74 in. 23,62 in. 31,49 in. 47,24 in. 55,11 in.



### PENSILI ORIZZONTALI H. 35 CM. – P. 38 CM. HORIZONTAL WALL UNITS H. 13,77 IN. – D. 14,96 IN.

CON ANTA  
WITH DOOR

40 cm.  
15,74 in.



A GIORNO CON CORNICE MASSELLO  
OPEN WITH SOLID FRAME

40 cm. 60 cm. 80 cm. 120 cm. 140 cm.  
15,74 in. 23,62 in. 31,49 in. 47,24 in. 55,11 in.

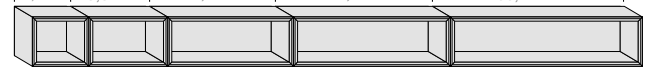

CON ANTA A RIBALTA  
WITH DROP-DOWN DOOR

40 cm. 60 cm. 80 cm. 120 cm. 140 cm.  
15,74 in. 23,62 in. 31,49 in. 47,24 in. 55,11 in.

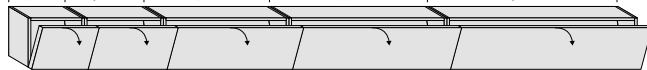

CON ANTA VASISTAS  
WITH LIFT-UP DOOR

40 cm. 60 cm. 80 cm. 120 cm. 140 cm.  
15,74 in. 23,62 in. 31,49 in. 47,24 in. 55,11 in.

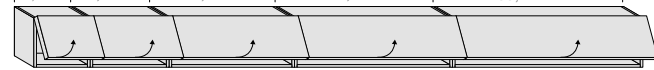

## MODULARITÀ MODULARITY

**PENSILI ORIZZONTALI H. 60 CM. – P. 38 CM.**  
HORIZONTAL WALL UNITS H. 23,62 IN. – D. 14,96 IN.

CON ANTA  
WITH DOOR

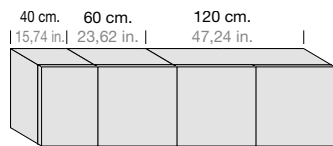

**PENSILI ORIZZONTALI H. 70 CM. – P. 38 CM.**  
HORIZONTAL WALL UNITS H. 27,55 IN. – D. 14,96 IN.

CON ANTA  
WITH DOOR

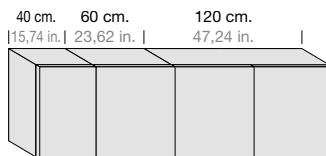

**PENSILI VERTICALI H. 105 CM. – P. 38 CM.**  
VERTICAL WALL UNITS H. 41,33 IN. – D. 14,96 IN.

CON ANTA  
WITH DOOR

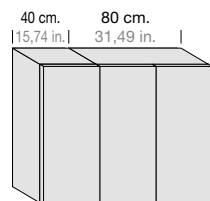

**PENSILI VERTICALI H. 120 CM. – P. 38 CM.**  
VERTICAL WALL UNITS H. 47,24 IN. – D. 14,96 IN.

CON ANTE  
WITH DOORS

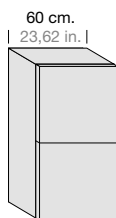

**PENSILI VERTICALI H. 140 CM. – P. 38 CM.**  
VERTICAL WALL UNITS H. 55,11 IN. – D. 14,96 IN.

CON ANTA  
WITH DOOR

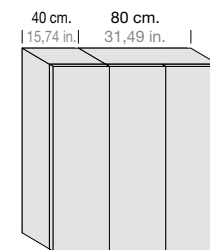

**PENSILI A GIORNO – P. 38 CM.**  
OPEN WALL UNITS – D. 14,96 IN.

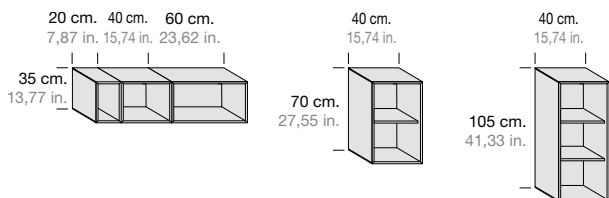

**COLONNE A GIORNO IN APPOGGIO – P. 30 CM.**  
RAISED OPEN TALL UNITS – D. 11,81 IN.

CON CAPPELLO  
WITH TOP

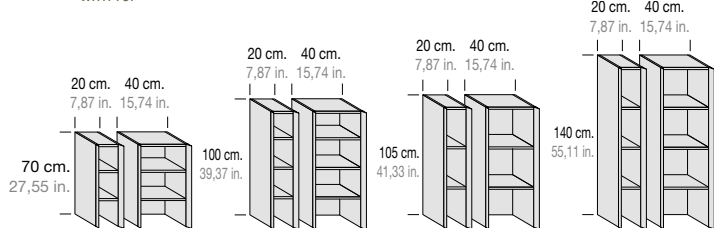

**COLONNE A GIORNO IN APPOGGIO SOTTOPENSILE**  
RAISED OPEN TALL UNITS UNDER WALL UNIT

SENZA CAPPELLO  
WITHOUT TOP

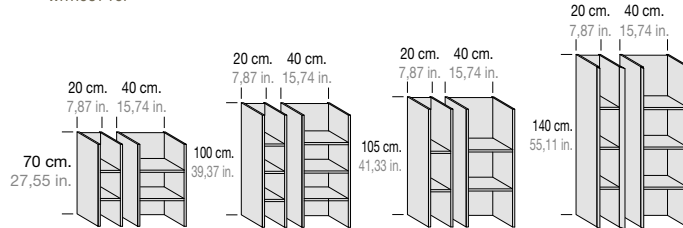

**DIVISORI AD "U" IN APPOGGIO SU MENSOLA E SOTTOPENSILE – P. 30 CM.**  
U-SHAPED PARTITIONS ON SHELF AND UNDER WALL UNIT – D. 11,81 IN.

SENZA TOP E FONDO  
WITHOUT TOP AND BOTTOM

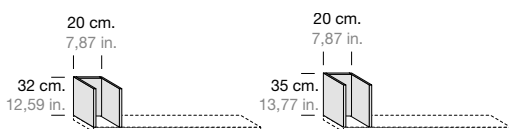

**PANNELLO BOISERIE TV SP. 6 CM.**  
BOISERIE TV PANEL TH. 2,36 IN.

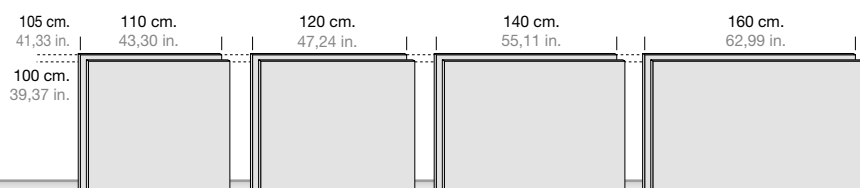

# SISTEMA COMPONIBILE - MODULAR SYSTEM

## CARATTERISTICHE TECNICHE E PARTICOLARITÀ DI UTILIZZO

### TECHNICAL CHARACTERISTICS AND PARTICULAR USE

#### ALTEZZA E LARGHEZZA CESTONI

#### BASKET HEIGHT AND WIDTH

##### FRONTALE CESTONE BASKET FRONT

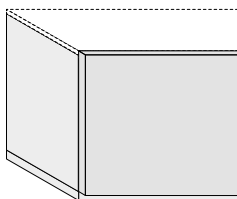

##### ALTEZZE CESTONI BASKET HEIGHTS

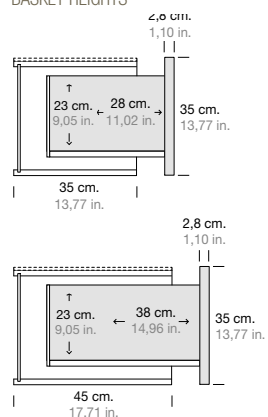

##### LARGHEZZE CESTONI BASKET WIDTHS

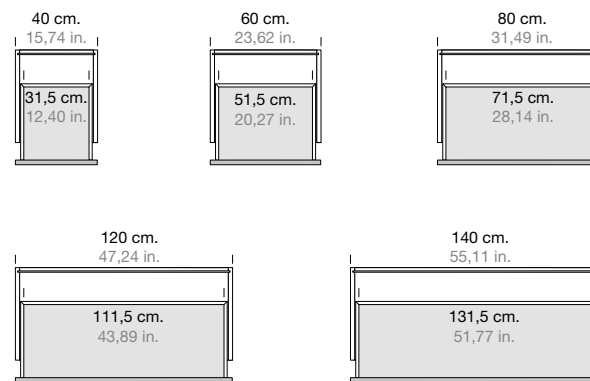

#### ALTEZZE MASSIME DI POSIZIONAMENTO ANTE VASISTAS/RIBALTA

#### MAXIMUM POSITION HEIGHTS FOR LIFT-UP/DROP-DOWN DOORS

#### È POSSIBILE SOVRAPPORRE ANTE VASISTAS SI VASISTAS E RIBALTA SU RIBALTA

IT IS POSSIBLE TO STACK LIFT-UP DOORS ON LIFT-UP DOORS AND DROP-DOWN DOORS ON DROP-DOWN DOORS

##### ANTA VASISTAS LIFT-UP DOOR

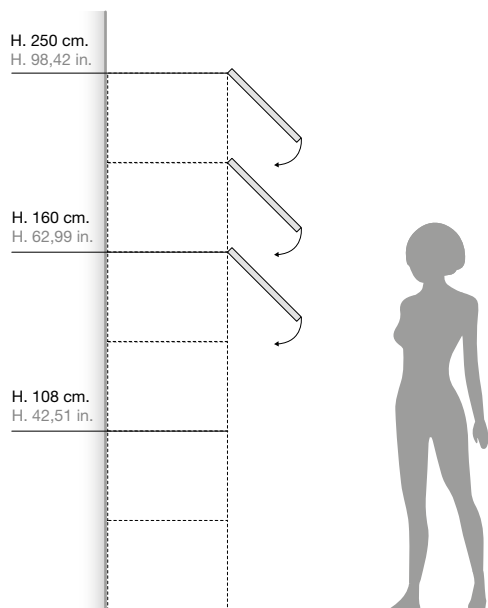

##### ANTA RIBALTA DROP-DOWN DOOR

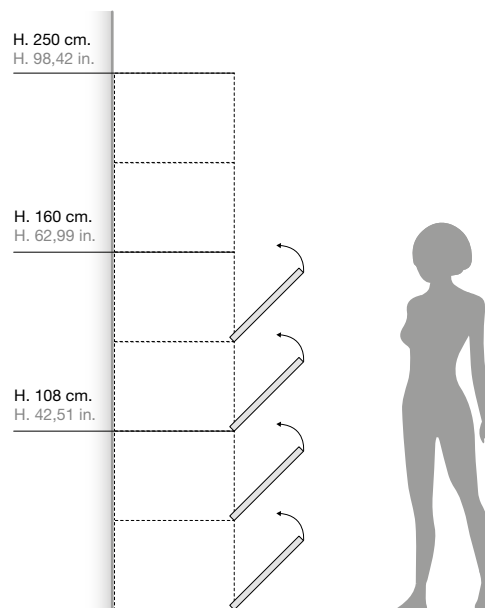

POSIZIONAMENTO ANTE A VASISTAS DA H. 160 CM. A H. 250 CM.  
POSITION OF LIFT-UP DOORS FROM H. 62,99 IN. TO H. 98,42 IN.

POSIZIONAMENTO ANTE A RIBALTA DA H. 4.5 CM. A H. 160 CM.  
POSITION OF DROP-DOWN DOORS H. 1,77 IN. A H. 62,99 IN.



## CARATTERISTICHE TECNICHE E PARTICOLARITÀ DI UTILIZZO

### TECHNICAL CHARACTERISTICS AND PARTICULAR USE

#### BASE A GIORNO CON CORNICE APPLICATA P. 38/48 CM.

OPEN BASE UNIT WITH APPLIED FRAME D. 14,96/18,89 IN.

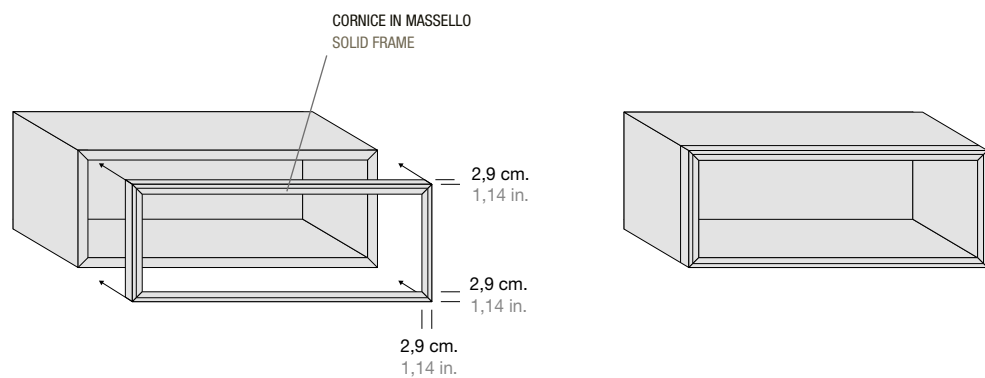

#### PENSILI VERTICALI CON ANTA VETRO P. 38 CM.

VERTICAL WALL UNITS WITH GLASS DOOR D. 14,96 IN.

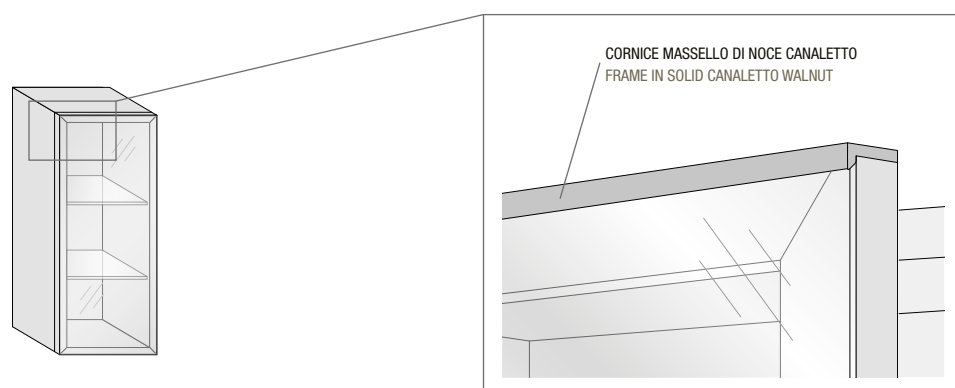

IL VETRO SI INFILA DI LATO E VIENE FISSATO DA DIETRO TRAMITE UN ELEMENTO DECORATIVO DI FORMA CIRCOLARE IN NOCE CANALETTO  
THE GLASS IS SLOTTED IN FROM THE SIDE AND SECURED FROM BEHIND WITH A CIRCULAR DECORATIVE ELEMENT IN CANALETTO WALNUT.

#### ATTACCAGLIA PER PENSILI (DI SERIE) E

#### BASI SOSPENSE

BRACKETS FOR WALL UNITS (AS STANDARD) AND SUSPENDED BASE UNITS

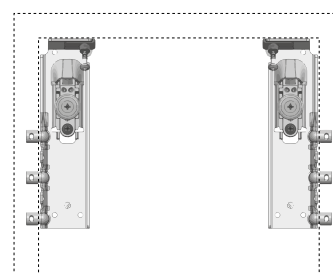

L'ATTACCAGLIA PREVEDE IL MONTAGGIO IN APPOGGIO AL CAPPELLO NEL RETRO DEL MOBILE, CONSENTENDO IL PERFETTO APPOGGIO A MURO.  
DISPONIBILE DX O SX.  
PORTATA KG. 70 PER ATTACCAGLIA.

HANGERS ARE TO BE FITTED TO THE FINISHING TOP ON THE BACK OF THE UNIT SO THAT IT CAN ADHERE PERFECTLY TO THE WALL.  
AVAILABLE R/H OR L/H.  
CAPACITY 70KG PER HANGER.

#### DIVISORI AD "U" P. 30 CM. PER MENSOLE

U-SHAPED PARTITIONS D. 11,81 IN. FOR SHELVES

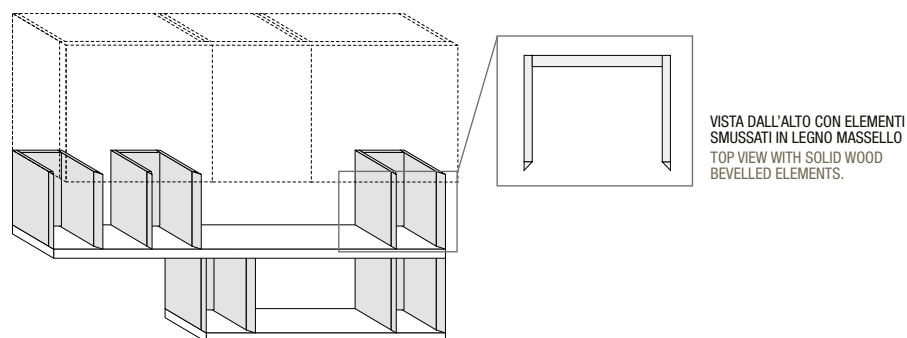

DIVISORI AD "U" SONO DOTATI DI GIUNZIONI INVISIBILI (VEDI ESEMPIO PAG. SEGUENTE)  
U-SHAPED PARTITIONS ARE FITTED WITH INVISIBLE JOINTS (SEE EXAMPLE IN THE FOLLOWING PAGE)

# SISTEMA COMPONIBILE - MODULAR SYSTEM

## CARATTERISTICHE TECNICHE E PARTICOLARITÀ DI UTILIZZO

### TECHNICAL CHARACTERISTICS AND PARTICULAR USE

#### UTILIZZO COLONNE A GIORNO P. 38 CM.

USE OF OPEN TALL UNITS D. 14,96 IN.

#### ESEMPIO DI COMPOSIZIONE COLONNE A GIORNO IN APPOGGIO SOTTOPENSILE E MENSOLE DI GIUNZIONE

EXAMPLE OF COMPOSITION WITH RAISED TALL UNITS UNDER WALL UNIT AND JOINT SHELVES

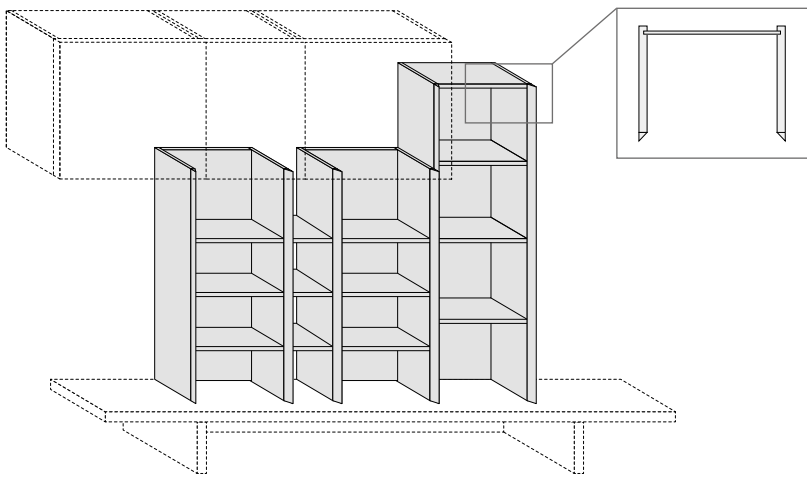

VISTA DALL'ALTO CON ELEMENTI SMUSSATI IN LEGNO MASSELLO  
TOP VIEW WITH SOLID WOOD BEVELLED ELEMENTS.

#### ESEMPIO DI COMPOSIZIONE COLONNE A GIORNO IN APPOGGIO E MENSOLE DI GIUNZIONE

EXAMPLE OF COMPOSITION WITH RAISED TALL UNITS AND JOINT SHELVES

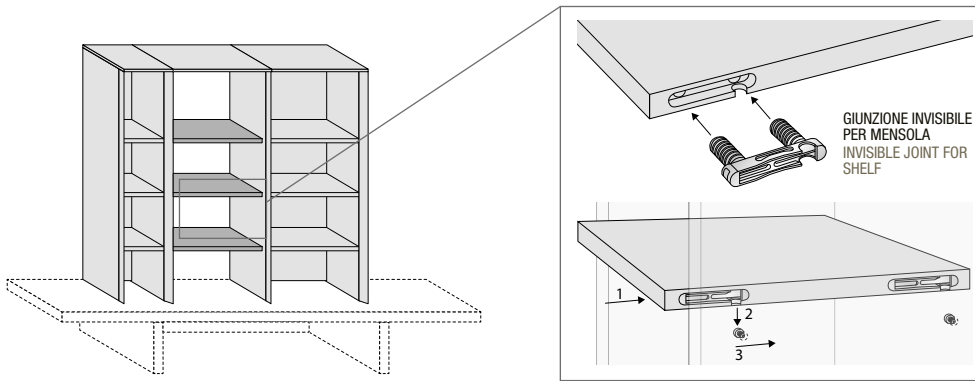

GIUNZIONE INVISIBILE PER MENSOLA  
INVISIBLE JOINT FOR SHELF

#### ATTACCAGLIA PER PENSILI (DI SERIE) E BASI SOSPENSE BRACKETS FOR WALL UNITS (AS STANDARD) AND SUSPENDED BASE UNITS

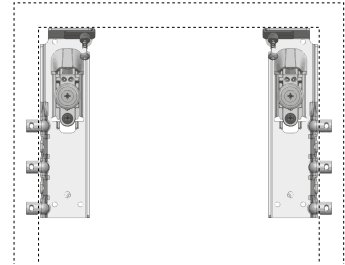

L'ATTACCAGLIA PREVEDE IL MONTAGGIO IN APPOGGIO AL CAPPELLO NEL RETRO DEL MOBILE, CONSENTENDO IL PERFETTO APPOGGIO A MURO.  
DISPONIBILE DX O SX.  
PORTATA KG. 70 PER ATTACCAGLIA.

HANGERS ARE TO BE FITTED TO THE FINISHING TOP ON THE BACK OF THE UNIT SO THAT IT CAN ADHERE PERFECTLY TO THE WALL.  
AVAILABLE R/H OR L/H.  
CAPACITY 70KG PER HANGER.

#### TOP OBBLIGATORIO PER BASI COMPULSORY TOP FOR BASE UNITS

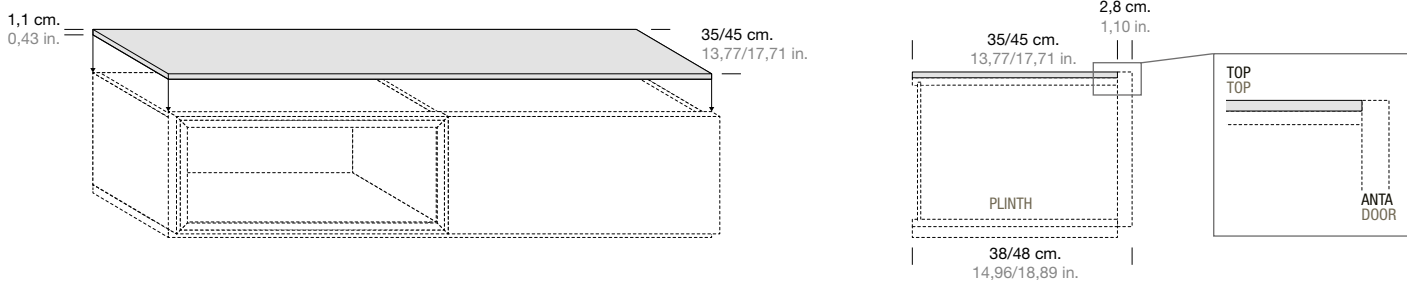

#### PEDANE P. 49 CM. CON PIEDINO REGOLATORE PLATFORMS D. 19,29 IN. WITH ADJUSTABLE FOOT

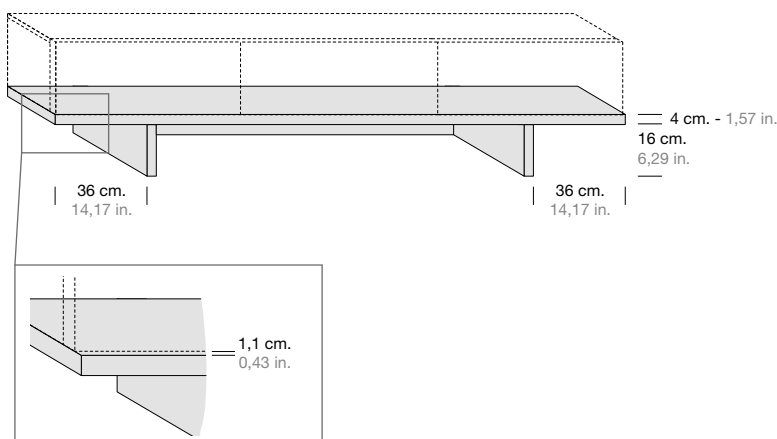

#### ZOCOLI P. 35/45 CM. CON PIEDINO REGOLATORE PLINTHS D. 13,77/17,71 IN. WITH ADJUSTABLE FOOT

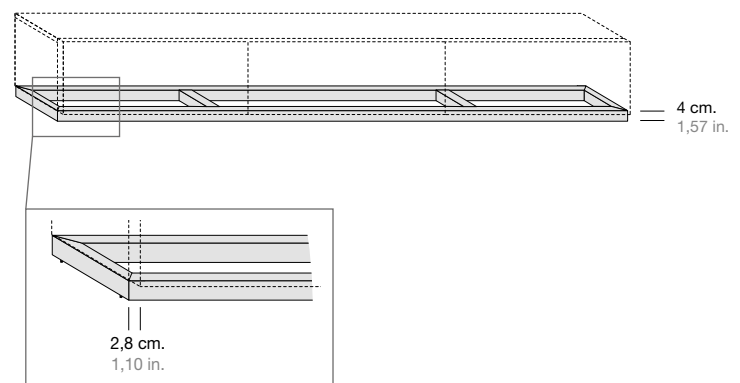

## ACCESSORI OPTIONAL OPTIONAL ACCESSORIES

### BARRA LED A BASSO CONSUMO ACCENSIONE TOUCH IN ALLUMINIO

COLLEGAMENTO  
A CARICO DEL CLIENTE

### LOW CONSUMPTION ALUMINIUM LED BAR WITH TOUCH SWITCH ON

CONNECTIONS  
TO BE MADE BY THE CUSTOMER.



larghezza width	codice code	NOCE-FRASSINO WALNUT-ASHWOOD
40   15,74	<b>ZZZFE22020</b>	<b>163</b>
60   23,62	<b>ZZZFE22024</b>	<b>175</b>
80   31,49	<b>ZZZFE22025</b>	<b>187</b>
120   47,24	<b>ZZZFE22026</b>	<b>235</b>
140   55,11	<b>ZZZFE22027</b>	<b>253</b>

### ALIMENTATORE POWER SUPPLY

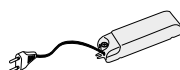

codice code	
<b>ZZZFE22002</b>	<b>67</b>

### TELECOMANDO REMOTE CONTROL



codice code	
<b>ZZZFE22004</b>	<b>158</b>

### KIT SPORTELLO PASSACAVI + BORCHIA

KIT FOR CABLE MANAGEMENT HOLE  
+ COVER

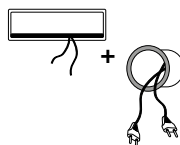

codice code	
<b>ZZZFE22005</b>	<b>133</b>

### MULTIPRESA A SCOMPARSA CON SPORTELLINO APRI/CHIUDI IN METALLO

CONCEALED MULTIPLE SOCKET  
WITH METAL OPEN/CLOSE FLAP

VERSIONE TV:  
1 PRESA SCHUKO  
2 PRESI USB RICARICA  
1 PRESA SAT.  
TV VERSION:  
1 SCHUKO SOCKET  
2 SOCKETS USB CHARGE  
1 SAT. SOCKET



codice code	
<b>ZZZFE22030</b>	<b>595</b>

VERSIONE PC/MAC:  
1 PRESA SCHUKO  
2 PORTE USB DATI  
1 PORTA HDMI  
PC/MAC VERSION:  
1 SCHUKO SOCKET  
2 USB PORT  
1 HDMI PORT



codice code	
<b>ZZZFE22031</b>	<b>595</b>

# SISTEMA COMPONIBILE - MODULAR SYSTEM

## ELEMENTI STRUTTURALI

## STRUCTURAL ELEMENTS

### MENSOLE SP. 3 CM. P. 30 CM. SHELVES TH. 1,18 IN. D. 11,81 IN.

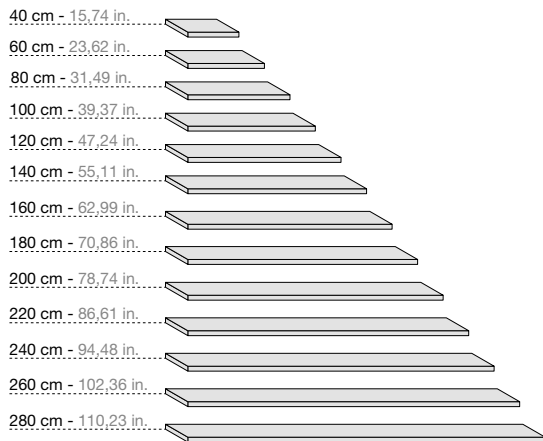

larghezza width	codice code	CANALETTO	
40   15,74	DOC3501K	97	mc 0,1 – Kg 2
60   23,62	DOC3511K	120	mc 0,01 – Kg 3
80   31,49	DOC3521K	158	mc 0,01 – Kg 4
100   39,37	DOC3531K	181	mc 0,01 – Kg 5
120   47,24	DOC3541K	217	mc 0,01 – Kg 6
140   55,11	DOC3551K	247	mc 0,01 – Kg 7
160   62,99	DOC3561K	278	mc 0,02 – Kg 8
180   70,86	DOC3571K	301	mc 0,02 – Kg 9
200   78,74	DOC3581K	338	mc 0,02 – Kg 10
220   86,61	DOC3591K	374	mc 0,02 – Kg 11
240   94,48	DOC3601K	404	mc 0,02 – Kg 12
260   102,36	DOC3611K	427	mc 0,03 – Kg 13
280   110,23	DOC3621K	457	mc 0,03 – Kg 14

### MENSOLONI SP. 6 CM. P. 50 CM.

#### DA APPOGGIO

POSIZIONABILI  
MAX H. 1,2 METRI  
PER AUTOPORTANTE  
AGGIUNGERE STAFFE  
DA MURO  
(+ 50,00 €)

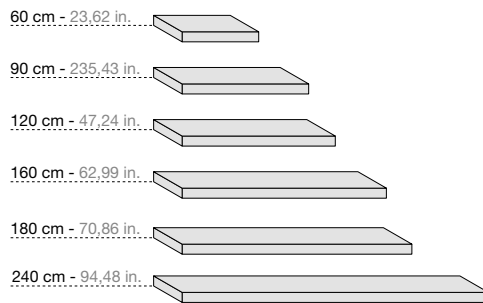

LARGE SHELVES  
TH. 2,36 IN.  
D 19,68 IN.  
SELF-STANDING  
1,2 METER MAX  
ADJUSTABLE  
FOR SELF-SUPPORTING  
ADD WALL BRACKETS  
(+ 50,00 €)

larghezza width	codice code	CANALETTO	
60   23,62	DOC3701K	253	mc 0,04 – Kg 8
90   35,43	DOC3711K	361	mc 0,06 – Kg 12
120   47,24	DOC3721K	476	mc 0,08 – Kg 16
160   62,99	DOC3731K	595	mc 0,16 – Kg 21
180   70,86	DOC3741K	668	mc 0,10 – Kg 24
240   94,48	DOC3751K	854	mc 0,15 – Kg 32

### BOISERIE TV SP. 5.7 CM.

#### TV BOISERIE TH. 2,24 IN.

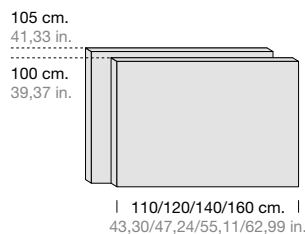

altezza height	larghezza width	codice code	CANALETTO	
100   39,37	110   47,24	DOC7041K	577	mc 0,07 – Kg 28
100   39,37	120   47,24	DOC7051K	644	mc 0,08 – Kg 34
100   39,37	140   55,11	DOC7061K	727	mc 0,10 – Kg 40
100   39,37	160   62,99	DOC7071K	813	mc 0,12 – Kg 42
105   41,33	110   47,24	DOC7011K	595	mc 0,07 – Kg 28
105   41,33	120   47,24	DOC7021K	655	mc 0,08 – Kg 34
105   41,33	140   55,11	DOC7031K	740	mc 0,10 – Kg 40
105   41,33	160   62,99	DOC7081K	823	mc 0,12 – Kg 42

### PEDANE H. 20 CM. P. 49 CM.

#### PLATFORMS H. 7,87 IN. D. 19,29 IN.

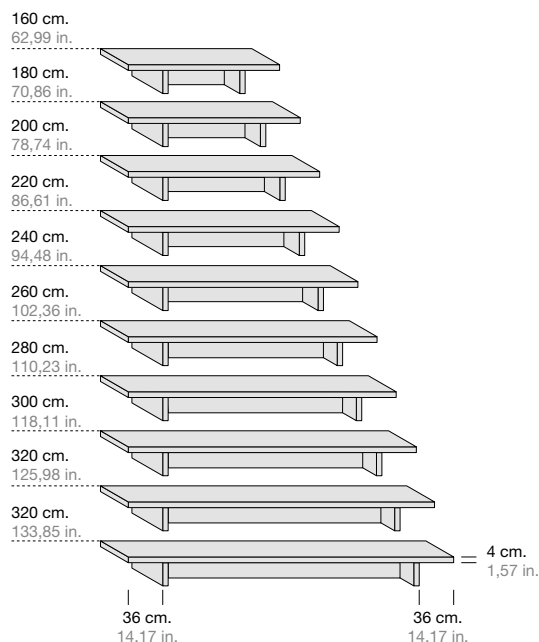

larghezza width	codice code	CANALETTO	
160   62,99	DOC3381K	615	mc 0,16 – Kg 18
180   70,86	DOC3000K	650	mc 0,22 – Kg 20
200   78,74	DOC3001K	692	mc 0,22 – Kg 22
220   86,61	DOC3011K	746	mc 0,24 – Kg 24
240   94,48	DOC3021K	800	mc 0,26 – Kg 26
260   102,36	DOC3031K	848	mc 0,28 – Kg 28
280   110,23	DOC3041K	938	mc 0,30 – Kg 30
300   118,11	DOC3051K	999	mc 0,32 – Kg 32
320   125,98	DOC3061K	1.023	mc 0,34 – Kg 34
340   133,85	DOC3071K	1.047	mc 0,37 – Kg 36

## ELEMENTI STRUTTURALI STRUCTURAL ELEMENTS

**ZOCCOLI H. 4 CM. P. 35 CM.**  
**PLINTHS H. 1,57 IN. D. 13,77 IN.**

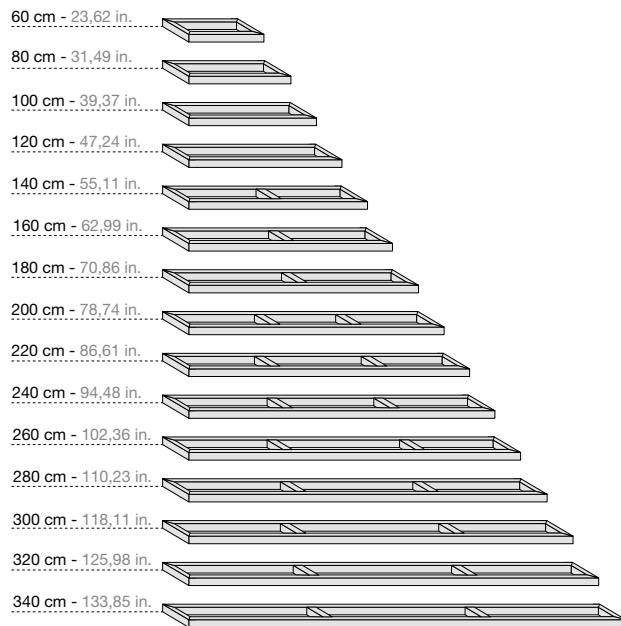

larghezza width	codice code	CANALETTO	
60   23,62	DOC3231K	181	mc 0,01 – Kg 1
80   31,49	DOC3241K	193	mc 0,02 – Kg 1
100   39,37	DOC3251K	198	mc 0,03 – Kg 2
120   47,24	DOC3261K	211	mc 0,03 – Kg 2
140   55,11	DOC3271K	223	mc 0,03 – Kg 2
160   62,99	DOC3281K	259	mc 0,03 – Kg 2
180   70,86	DOC3291K	278	mc 0,03 – Kg 2
200   78,74	DOC3301K	326	mc 0,03 – Kg 4
220   86,61	DOC3311K	338	mc 0,03 – Kg 4
240   94,48	DOC3321K	349	mc 0,04 – Kg 4
260   102,36	DOC3331K	361	mc 0,03 – Kg 5
280   110,23	DOC3341K	409	mc 0,03 – Kg 6
300   118,11	DOC3351K	422	mc 0,05 – Kg 6
320   125,98	DOC3361K	439	mc 0,05 – Kg 6
340   133,85	DOC3371K	457	mc 0,05 – Kg 7

**ZOCCOLI H. 4 CM. P. 45 CM.**  
**PLINTHS H. 1,57 IN. D. 17,71 IN.**

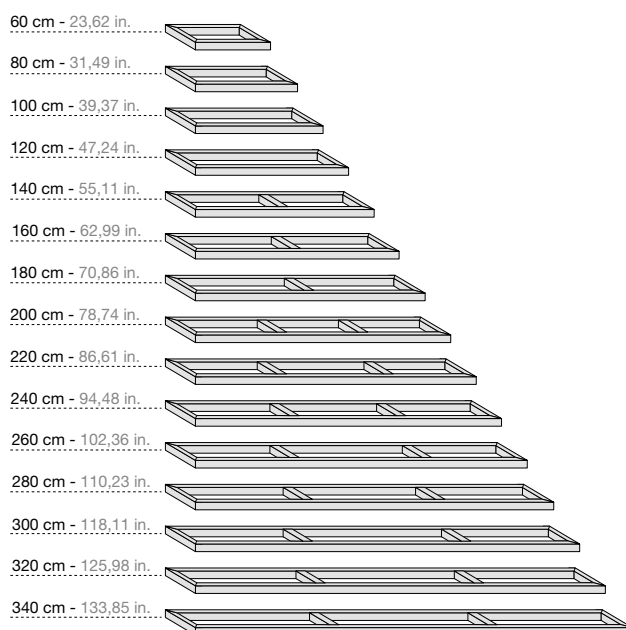

larghezza width	codice code	CANALETTO	
60   23,62	DOC3081K	181	mc 0,02 – Kg 1
80   31,49	DOC3091K	193	mc 0,02 – Kg 1
100   39,37	DOC3101K	206	mc 0,02 – Kg 2
120   47,24	DOC3111K	217	mc 0,02 – Kg 2
140   55,11	DOC3121K	235	mc 0,03 – Kg 2
160   62,99	DOC3131K	259	mc 0,03 – Kg 3
180   70,86	DOC3141K	278	mc 0,04 – Kg 03
200   78,74	DOC3151K	326	mc 0,04 – Kg 5
220   86,61	DOC3161K	338	mc 0,04 – Kg 5
240   94,48	DOC3171K	349	mc 0,05 – Kg 5
260   102,36	DOC3181K	366	mc 0,05 – Kg 5
280   110,23	DOC3191K	409	mc 0,06 – Kg 7
300   118,11	DOC3201K	427	mc 0,06 – Kg 7
320   125,98	DOC3211K	446	mc 0,06 – Kg 7
340   133,85	DOC3221K	457	mc 0,06 – Kg 8

# SISTEMA COMPONIBILE - MODULAR SYSTEM

## ELEMENTI STRUTTURALI

## STRUCTURAL ELEMENTS

**TOP SP. 1.1 CM. P 35 CM.**  
**OBBLIGATORIO PER BASI**

**TOP TH. 0,43 IN. D 13,77 IN.**  
**COMPULSORY FOR BASE**  
**UNITS**

**IL PREZZO DEL TOP DEVE ESSERE SOMMATO A QUELLO DELLE BASI**  
**ADD THE PRICE OF THE TOP TO THE PRICE OF THE BASE UNITS.**

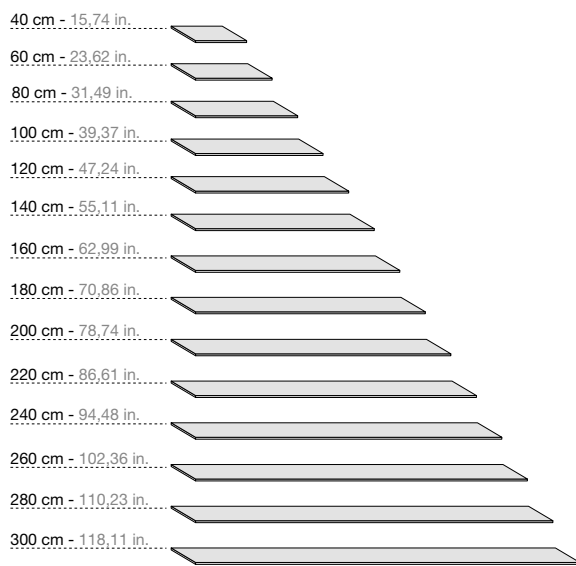

larghezza width	codice code	CANALETTO	
40   15,74	DOC5151K	61	mc 0,05 - Kg 1
60   23,62	DOC5161K	85	mc 0,05 - Kg 1
80   31,49	DOC5171K	102	mc 0,05 - Kg 1
100   39,37	DOC5181K	158	mc 0,05 - Kg 2
120   47,24	DOC5191K	133	mc 0,05 - Kg 2
140   55,11	DOC5201K	193	mc 0,05 - Kg 2
160   62,99	DOC5211K	223	mc 0,05 - Kg 3
180   70,86	DOC5221K	241	mc 0,06 - Kg 3
200   78,74	DOC5231K	253	mc 0,06 - Kg 4
220   86,61	DOC5241K	265	mc 0,06 - Kg 4
240   94,48	DOC5251K	289	mc 0,06 - Kg 4
260   102,36	DOC5261K	301	mc 0,06 - Kg 5
280   110,23	DOC5271K	326	mc 0,06 - Kg 5
300   118,11	DOC5281K	356	mc 0,06 - Kg 5

**TOP SP. 1.1 CM. P 45 CM.**  
**OBBLIGATORIO PER BASI**

**TOP TH. 0,43 IN. D 17,71 IN.**  
**COMPULSORY FOR BASE**  
**UNITS**

**IL PREZZO DEL TOP DEVE ESSERE SOMMATO A QUELLO DELLE BASI**  
**ADD THE PRICE OF THE TOP TO THE PRICE OF THE BASE UNITS.**

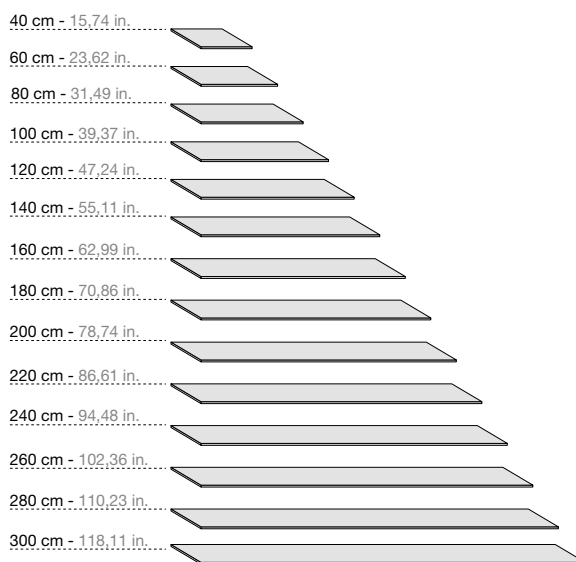

larghezza width	codice code	CANALETTO	
40   15,74	DOC5001K	67	mc 0,03 - Kg 1
60   23,62	DOC5011K	91	mc 0,05 - Kg 1
80   31,49	DOC5021K	115	mc 0,05 - Kg 2
100   39,37	DOC5031K	150	mc 0,05 - Kg 2
120   47,24	DOC5041K	175	mc 0,05 - Kg 3
140   55,11	DOC5051K	206	mc 0,05 - Kg 3
160   62,99	DOC5061K	253	mc 0,05 - Kg 4
180   70,86	DOC5071K	271	mc 0,06 - Kg 4
200   78,74	DOC5081K	295	mc 0,06 - Kg 5
220   86,61	DOC5091K	326	mc 0,06 - Kg 5
240   94,48	DOC5101K	349	mc 0,06 - Kg 5
260   102,36	DOC5111K	374	mc 0,06 - Kg 6
280   110,23	DOC5121K	397	mc 0,06 - Kg 6
300   118,11	DOC5131K	422	mc 0,06 - Kg 7

## ELEMENTI STRUTTURALI STRUCTURAL ELEMENTS

**TOP SP. 1.3 CM. P 38 CM.  
OPTIONAL PER PENSILI E  
MADIE**

**TOP TH. 0,51 IN. D 14,96 IN.  
OPTIONAL FOR WALL UNITS  
AND CUPBOARDS**

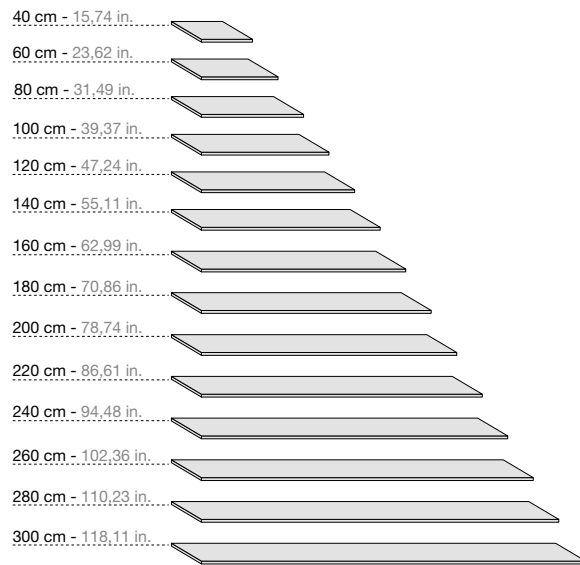

larghezza width	codice code	CANALETTO	
40   15,74	DOC5300K	91	mc 0,05 – Kg 1
60   23,62	DOC5301K	97	mc 0,05 – Kg 1
80   31,49	DOC5311K	115	mc 0,05 – Kg 1
100   39,37	DOC5321K	150	mc 0,05 – Kg 2
120   47,24	DOC5331K	181	mc 0,05 – Kg 2
140   55,11	DOC5341K	217	mc 0,05 – Kg 2
160   62,99	DOC5351K	253	mc 0,05 – Kg 3
180   70,86	DOC5361K	271	mc 0,06 – Kg 3
200   78,74	DOC5371K	289	mc 0,06 – Kg 4
220   86,61	DOC5381K	308	mc 0,06 – Kg 4
240   94,48	DOC5391K	338	mc 0,06 – Kg 4
260   102,36	DOC5401K	361	mc 0,06 – Kg 5
280   110,23	DOC5411K	386	mc 0,06 – Kg 5
300   118,11	DOC5421K	409	mc 0,06 – Kg 5

# SISTEMA COMPONIBILE - MODULAR SYSTEM

## BASI A TERRA P. 38 CM.

### FLOOR-STANDING BASE UNITS D. 14,96 IN.

#### BASI H. 35 CM.

#### BASE UNITS H. 13,77 IN.

A GIORNO  
OPEN

A GIORNO, 1 RIPIANO VETRO  
OPEN ON PLATFORM, 1 GLASS SHELF

1 CESTONE  
1 BASKET

1 CESTONE  
1 BASKET

40 cm.  
15,74 in.



40 cm.  
15,74 in.



40 cm.  
15,74 in.



40 cm.  
15,74 in.



**OBBLIGATORIO: AGGIUNGERE TOP E PEDANA O ZOCCOLO A TERRA.**  
**COMPULSORY: ADD TOP AND PLATFORM OR PLINTH ON FLOOR.**

**DOC1511K**

**DOC1561K**

**DOC1311K**

DOGA LEGNO LISCIA  
PLAIN WOODEN SLAT

**DOC1316K**

**OPTIONAL**

DOGA SLAT  
DOGA RIGHE  
STRIPED SLAT

**529**

**559**

**680**

**903**

**+ 67**

CANALETTO

Doghe Multicolor - Multicolor slats

mc 0,06 - Kg 5

mc 0,06 - Kg 5

mc 0,06 - Kg 10

mc 0,06 - Kg 10

1 CESTONE  
1 BASKET

1 CESTONE  
1 BASKET

1 RIBALTA  
1 DROP-DOWN DOOR

60 cm.  
23,62 in.



60 cm.  
23,62 in.



60 cm.  
23,62 in.

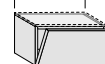

**OBBLIGATORIO: AGGIUNGERE TOP E PEDANA O ZOCCOLO A TERRA.**  
**COMPULSORY: ADD TOP AND PLATFORM OR PLINTH ON FLOOR.**

**DOC1331K**

**DOC1336K**

**OPTIONAL**

**DOC1431K**

DOGA LEGNO LISCIA  
PLAIN WOODEN SLAT

DOGA SLAT

DOGA RIGHE  
STRIPED SLAT

DOGA QUADRO LEGNO  
WOODEN SQUARE SLAT

**788**

**1.029**

**+ 67**

**+ 97**

**800**

**+ 5 %**

CANALETTO

Doghe Multicolor - Multicolor slats

mc 0,09 - Kg 12

mc 0,09 - Kg 12

mc 0,09 - Kg 10

1 CESTONE  
1 BASKET

1 CESTONE  
1 BASKET

1 RIBALTA  
1 DROP-DOWN DOOR

80 cm.  
31,49 in.



80 cm.  
31,49 in.



80 cm.  
31,49 in.

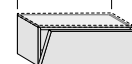

**OBBLIGATORIO: AGGIUNGERE TOP E PEDANA O ZOCCOLO A TERRA.**  
**COMPULSORY: ADD TOP AND PLATFORM OR PLINTH ON FLOOR.**

**DOC1351K**

**DOC1356K**

**OPTIONAL**

**DOC1451K**

DOGA LEGNO LISCIA  
PLAIN WOODEN SLAT

DOGA SLAT

DOGA RIGHE  
STRIPED SLAT

DOGA QUADRO LEGNO  
WOODEN SQUARE SLAT

**903**

**1.155**

**+ 67**

**+ 97**

**890**

**+ 5 %**

CANALETTO

Doghe Multicolor - Multicolor slats

mc 0,12 - Kg 16

mc 0,09 - Kg 16

mc 0,12 - Kg 8

1 CESTONE  
1 BASKET

1 CESTONE  
1 BASKET

1 RIBALTA  
1 DROP-DOWN DOOR

120 cm.  
47,24 in.



120 cm.  
47,24 in.



120 cm.  
47,24 in.



**OBBLIGATORIO: AGGIUNGERE TOP E PEDANA O ZOCCOLO A TERRA.**  
**COMPULSORY: ADD TOP AND PLATFORM OR PLINTH ON FLOOR.**

**DOC1371K**

**DOC1376K**

**OPTIONAL**

**DOC1471K**

DOGA LEGNO LISCIA  
PLAIN WOODEN SLAT

DOGA SLAT

DOGA RIGHE  
STRIPED SLAT

DOGA QUADRO LEGNO  
WOODEN SQUARE SLAT

**1.047**

**1.341**

**+ 67**

**+ 97**

**1.011**

**+ 5 %**

CANALETTO

Doghe Multicolor - Multicolor slats

mc 0,18 - Kg 18

mc 0,18 - Kg 18

mc 0,18 - Kg 15



1 RIBALTA  
1 DROP-DOWN DOOR

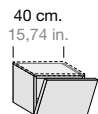

**DOC1411K**

**703**

**+ 5 %**

mc 0,06 – Kg 8

1 RIBALTA  
1 DROP-DOWN DOOR

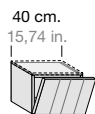

DOGA LEGNO LISCIA  
PLAIN WOODEN SLAT

**DOC1416K**

**944**

**+ 5 %**

mc 0,06 – Kg 8

**OPTIONAL**

DOGA SLAT  
DOGA RIGHE  
STRIPED SLAT

**+ 67**

A GIORNO  
OPEN

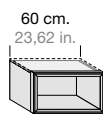

**DOC1521K**

**638**

mc 0,09 – Kg 7

A GIORNO, 1 RIPIANO VETRO  
OPEN ON PLATFORM, 1 GLASS SHELF

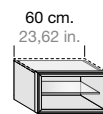

**DOC1571K**

**674**

mc 0,09 – Kg 7

**OPTIONAL**  
**OPTIONAL**

KIT SPORTELLINO PASSACAVI  
+ BORCHIA  
KIT FOR CABLE MANAGEMENT HOLE  
+ COVER

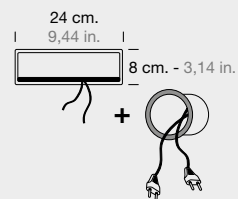

**ZZZFE22005**

**133**

1 RIBALTA  
1 DROP-DOWN DOOR

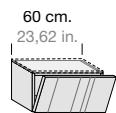

DOGA LEGNO LISCIA  
PLAIN WOODEN SLAT

**DOC1436K**

**1.052**

**+ 5 %**

mc 0,09 – Kg 10

**OPTIONAL**

DOGA SLAT  
DOGA RIGHE  
STRIPED SLAT

**+ 67**

**+ 97**

A GIORNO  
OPEN

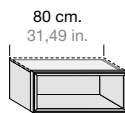

**DOC1531K**

**727**

mc 0,12 – Kg 11

A GIORNO, 1 RIPIANO VETRO  
OPEN ON PLATFORM, 1 GLASS SHELF

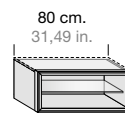

**DOC1581K**

**764**

mc 0,12 – Kg 11

1 RIBALTA  
1 DROP-DOWN DOOR

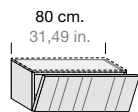

DOGA LEGNO LISCIA  
PLAIN WOODEN SLAT

**DOC1456K**

**1.173**

**+ 5 %**

mc 0,12 – Kg 8

**OPTIONAL**

DOGA SLAT  
DOGA RIGHE  
STRIPED SLAT

**+ 67**

**+ 97**

A GIORNO  
OPEN

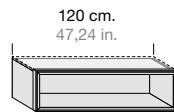

**DOC1541K**

**842**

mc 0,18 – Kg 13

A GIORNO, 1 RIPIANO VETRO  
OPEN ON PLATFORM, 1 GLASS SHELF

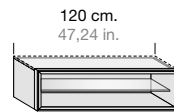

**DOC1591K**

**909**

mc 0,18 – Kg 13

1 RIBALTA  
1 DROP-DOWN DOOR

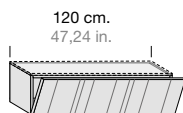

DOGA LEGNO LISCIA  
PLAIN WOODEN SLAT

**DOC1476K**

**1.328**

**+ 5 %**

mc 0,18 – Kg 15

**OPTIONAL**

DOGA SLAT  
DOGA RIGHE  
STRIPED SLAT

**+ 67**

**+ 97**

A GIORNO  
OPEN

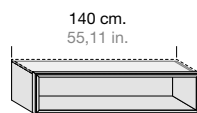

**DOC1551K**

**932**

mc 0,21 – Kg 15

A GIORNO, 1 RIPIANO VETRO  
OPEN ON PLATFORM, 1 GLASS SHELF

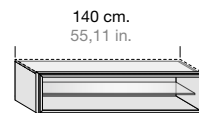

**DOC1601K**

**999**

mc 0,21 – Kg 15

# SISTEMA COMPONIBILE - MODULAR SYSTEM

## BASI A TERRA P. 38 CM.

### FLOOR-STANDING BASE UNITS D. 14,96 IN.

#### BASI H. 35 CM.

#### BASE UNITS H. 13,77 IN.

A GIORNO, 3 DIVISORI  
OPEN, 3 PARTITIONS

1 CESTONE  
1 BASKET

1 CESTONE  
1 BASKET

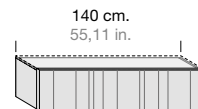
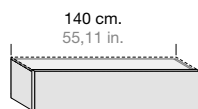
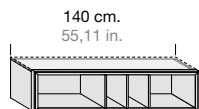

**OBBLIGATORIO: AGGIUNGERE TOP E PEDANA O ZOCCOLO A TERRA.**  
**COMPULSORY: ADD TOP AND PLATFORM OR PLINTH ON FLOOR.**

**DOC1611K**

**DOC1391K**

DOGA LEGNO LISCIA  
PLAIN WOODEN SLAT

**DOC1396K**

**OPTIONAL**

DOGA SLAT  
DOGA RIGHE  
STRIPED SLAT

DOGA QUADRO LEGNO  
WOODEN SQUARE SLAT

**1.136**

**1.149**

**1.408**

**+ 67**

CANALETTO

Doghe Multicolor - Multicolor slats

mc 0,21 - Kg 15

mc 0,21 - Kg 20

mc 0,21 - Kg 20

**+ 97**

#### SHANGHAI BASI H. 35 CM.

#### SHANGHAI

#### BASE UNITS H. 13,77 IN.

1 CESTONE  
1 BASKET

1 RIBALTA  
1 DROP-DOWN DOOR

1 CESTONE  
1 BASKET

1 RIBALTA  
1 DROP-DOWN DOOR

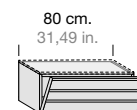
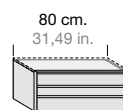
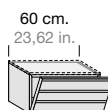
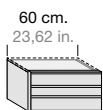

**OBBLIGATORIO: AGGIUNGERE TOP E PEDANA O ZOCCOLO A TERRA.**  
**COMPULSORY: ADD TOP AND PLATFORM OR PLINTH ON FLOOR.**

**SHC1001K**

**SHC1041K**

**SHC1011K**

**SHC1051K**

**866**

**903**

**956**

**992**

CANALETTO

Bicolore - Bicolor

mc 0,09 - Kg 12

mc 0,09 - Kg 10

mc 0,12 - Kg 16

mc 0,12 - Kg 8

#### BASI A TERRA P. 48 CM. FLOOR-STANDING BASE UNITS D. 18,89 IN.

#### BASI H. 35 CM.

#### BASE UNITS H. 13,77 IN.

A GIORNO  
OPEN

A GIORNO, 1 RIPIANO VETRO  
OPEN ON PLATFORM, 1 GLASS SHELF

1 CESTONE  
1 BASKET

1 CESTONE  
1 BASKET

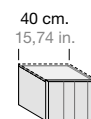
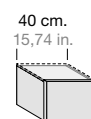
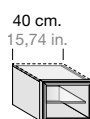
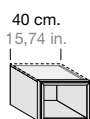

**OBBLIGATORIO: AGGIUNGERE TOP E PEDANA O ZOCCOLO A TERRA.**  
**COMPULSORY: ADD TOP AND PLATFORM OR PLINTH ON FLOOR.**

**DOC1211K**

**DOC1261K**

**DOC1001K**

DOGA LEGNO LISCIA  
PLAIN WOODEN SLAT

**DOC1006K**

**542**

**572**

**698**

**920**

CANALETTO

Doghe Multicolor - Multicolor slats

mc 0,07 - Kg 6

mc 0,07 - Kg 6

mc 0,07 - Kg 12

mc 0,07 - Kg 12

A GIORNO  
OPEN

A GIORNO, 1 RIPIANO VETRO  
OPEN ON PLATFORM, 1 GLASS SHELF

1 CESTONE  
1 BASKET

1 CESTONE  
1 BASKET

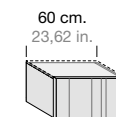
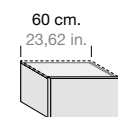
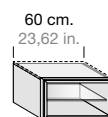
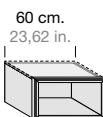

**OBBLIGATORIO: AGGIUNGERE TOP E PEDANA O ZOCCOLO A TERRA.**  
**COMPULSORY: ADD TOP AND PLATFORM OR PLINTH ON FLOOR.**

**DOC1221K**

**DOC1271K**

**DOC1021K**

DOGA LEGNO LISCIA  
PLAIN WOODEN SLAT

**DOC1026K**

**650**

**686**

**800**

**1.041**

CANALETTO

Doghe Multicolor - Multicolor slats

mc 0,11 - Kg 8

mc 0,11 - Kg 8

mc 0,11 - Kg 15

mc 0,11 - Kg 15

## BASI A TERRA P. 38 CM. FLOOR-STANDING BASE UNITS D. 14,96 IN.

1 RIBALTA  
1 DROP-DOWN DOOR

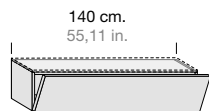

1 CESTONE  
1 BASKET

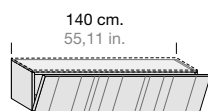

DOGA LEGNO LISCIA  
PLAIN WOODEN SLAT

DOC1491K	
1.160	
+ 5 %	
mc 0,21 – Kg 17	

DOC1496K	
1.443	
+ 5 %	
mc 0,21 – Kg 17	

OPTIONAL	
DOGA SLAT	
DOGA RIGHE STRIPED SLAT	DOGA QUADRO LEGNO WOODEN SQUARE SLAT
+ 67	+ 97

**OPTIONAL**  
**OPTIONAL**

KIT SPORTELLI PASSACAVI  
+ BORCHIA  
KIT FOR CABLE MANAGEMENT HOLE  
+ COVER

**ZZZFE22005**

**133**

1 CESTONE  
1 BASKET

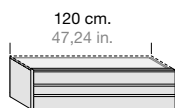

1 RIBALTA  
1 DROP-DOWN DOOR

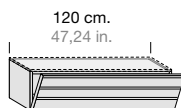

1 CESTONE  
1 BASKET

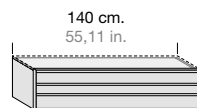

1 RIBALTA  
1 DROP-DOWN DOOR

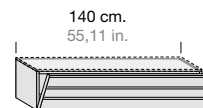

SHC1021K	
1.077	
+ 5 %	
mc 0,18 – Kg 18	

SHC1061K	
1.089	
+ 5 %	
mc 0,18 – Kg 15	

SHC1031K	
1.167	
+ 5 %	
mc 0,21 – Kg 20	

SHC1071K	
1.221	
+ 5 %	
mc 0,21 – Kg 17	

1 RIBALTA  
1 DROP-DOWN DOOR

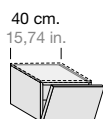

1 RIBALTA  
1 DROP-DOWN DOOR

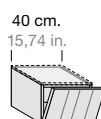

DOGA LEGNO LISCIA  
PLAIN WOODEN SLAT

OPTIONAL	
DOGA SLAT	
DOGA RIGHE STRIPED SLAT	DOGA QUADRO LEGNO WOODEN SQUARE SLAT
+ 67	+ 97

DOC1101K	
722	
+ 5 %	
mc 0,07 – Kg 9	

DOC1106K	
962	
+ 5 %	
mc 0,07 – Kg 9	

OPTIONAL	
DOGA SLAT	
DOGA RIGHE STRIPED SLAT	DOGA QUADRO LEGNO WOODEN SQUARE SLAT
+ 67	+ 97

1 RIBALTA  
1 DROP-DOWN DOOR

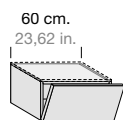

1 RIBALTA  
1 DROP-DOWN DOOR

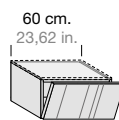

DOGA LEGNO LISCIA  
PLAIN WOODEN SLAT

OPTIONAL	
DOGA SLAT	
DOGA RIGHE STRIPED SLAT	DOGA QUADRO LEGNO WOODEN SQUARE SLAT
+ 67	+ 97

DOC1131K	
813	
+ 5 %	
mc 0,11 – Kg 11	

DOC1136K	
1.064	
+ 5 %	
mc 0,11 – Kg 11	

OPTIONAL	
DOGA SLAT	
DOGA RIGHE STRIPED SLAT	DOGA QUADRO LEGNO WOODEN SQUARE SLAT
+ 67	+ 97

# SISTEMA COMPONIBILE - MODULAR SYSTEM

## BASI A TERRA P. 48 CM.

### FLOOR-STANDING BASE UNITS D. 18,89 IN.

#### BASI H. 35 CM.

#### BASE UNITS H. 13,77 IN.

A GIORNO  
OPEN

A GIORNO, 1 RIPIANO VETRO  
OPEN ON PLATFORM, 1 GLASS SHELF

1 CESTONE  
1 BASKET

1 CESTONE  
1 BASKET

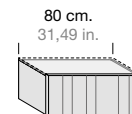
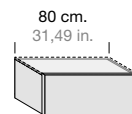
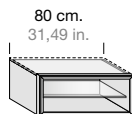
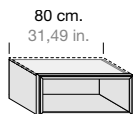

**OBBLIGATORIO: AGGIUNGERE TOP E PEDANA O ZOCCOLO A TERRA.**  
**COMPULSORY: ADD TOP AND PLATFORM OR PLINTH ON FLOOR.**

**DOC1231K**

**DOC1281K**

**DOC1041K**

DOGA LEGNO LISCIA  
PLAIN WOODEN SLAT

**DOC1046K**

CANALETTO

**735**

**770**

**909**

**1.160**

Doghe Multicolor - Multicolor slats

mc 0,15 - Kg 10

mc 0,15 - Kg 10

mc 0,15 - Kg 18

mc 0,15 - Kg 18

A GIORNO  
OPEN

A GIORNO, 1 RIPIANO VETRO  
OPEN ON PLATFORM, 1 GLASS SHELF

1 CESTONE  
1 BASKET

1 CESTONE  
1 BASKET

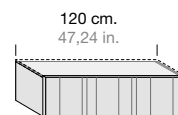
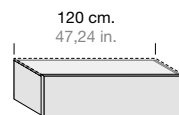
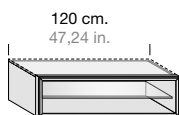
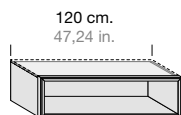

**OBBLIGATORIO: AGGIUNGERE TOP E PEDANA O ZOCCOLO A TERRA.**  
**COMPULSORY: ADD TOP AND PLATFORM OR PLINTH ON FLOOR.**

**DOC1241K**

**DOC1291K**

**DOC1061K**

DOGA LEGNO LISCIA  
PLAIN WOODEN SLAT

**DOC1066K**

CANALETTO

**854**

**914**

**1.059**

**1.353**

Doghe Multicolor - Multicolor slats

mc 0,22 - Kg 14

mc 0,22 - Kg 14

mc 0,22 - Kg 21

mc 0,22 - Kg 21

A GIORNO  
OPEN

A GIORNO, 1 RIPIANO VETRO  
OPEN ON PLATFORM,  
1 GLASS SHELF

A GIORNO, 3 DIVISORI  
OPEN, 3 PARTITIONS

1 CESTONE  
1 BASKET

1 CESTONE  
1 BASKET

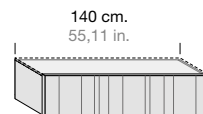
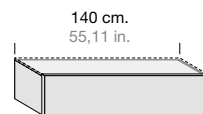
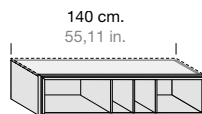
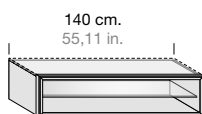
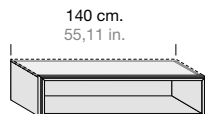

**OBBLIGATORIO: AGGIUNGERE TOP E PEDANA O ZOCCOLO A TERRA.**  
**COMPULSORY: ADD TOP AND PLATFORM OR PLINTH ON FLOOR.**

**DOC1251K**

**DOC1301K**

**DOC1621K**

**DOC1081K**

DOGA LEGNO LISCIA  
PLAIN WOODEN SLAT

**DOC1086K**

CANALETTO

**938**

**884**

**1.155**

**1.167**

**1.432**

Doghe Multicolor - Multicolor slats

mc 0,26 - Kg 18

mc 0,26 - Kg 18

mc 0,21 - Kg 15

mc 0,26 - Kg 23

mc 0,26 - Kg 23

## SHANGHAI BASI H. 35 CM.

### SHANGHAI BASE UNITS H. 13,77 IN.

1 CESTONE  
1 BASKET

1 RIBALTA  
1 DROP-DOWN DOOR

1 CESTONE  
1 BASKET

1 RIBALTA  
1 DROP-DOWN DOOR

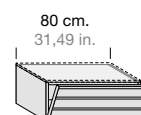
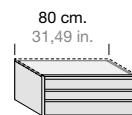
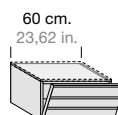
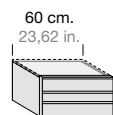

**OBBLIGATORIO: AGGIUNGERE TOP E PEDANA O ZOCCOLO A TERRA.**  
**COMPULSORY: ADD TOP AND PLATFORM OR PLINTH ON FLOOR.**

**SHC1081K**

**SHC1121K**

**SHC1091K**

**SHC1131K**

CANALETTO

**879**

**920**

**968**

**1.004**

Bicolore - Bicolor

**+ 5 %**

**+ 5 %**

**+ 5 %**

**+ 5 %**

mc 0,09 - Kg 12

mc 0,09 - Kg 10

mc 0,12 - Kg 16

mc 0,12 - Kg 8

## BASI A TERRA P. 48 CM. FLOOR-STANDING BASE UNITS D. 18,89 IN.

1 RIBALTA  
1 DROP-DOWN DOOR

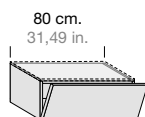

1 RIBALTA  
1 DROP-DOWN DOOR

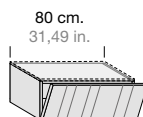

DOGA LEGNO LISCIA  
PLAIN WOODEN SLAT

DOGA LEGNO LISCIA  
PLAIN WOODEN SLAT

OPTIONAL	
DOGA SLAT	
DOGA RIGHE STRIPED SLAT	DOGA QUADRO LEGNO WOODEN SQUARE SLAT
+ 67	+ 97

DOC1151K
896
+ 5 %

mc 0,15 - Kg 13

DOC1156K
1.179
+ 5 %

mc 0,15 - Kg 13

OPTIONAL	
DOGA SLAT	
DOGA RIGHE STRIPED SLAT	DOGA QUADRO LEGNO WOODEN SQUARE SLAT
+ 67	+ 97

### OPTIONAL OPTIONAL

KIT SPORTELLINO PASSACAVI  
+ BORCHIA  
KIT FOR CABLE MANAGEMENT HOLE  
+ COVER

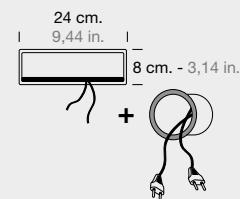

ZZZFE22005

133

1 RIBALTA  
1 DROP-DOWN DOOR

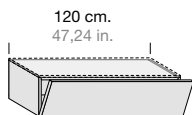

1 RIBALTA  
1 DROP-DOWN DOOR

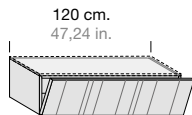

DOGA LEGNO LISCIA  
PLAIN WOODEN SLAT

DOGA LEGNO LISCIA  
PLAIN WOODEN SLAT

OPTIONAL	
DOGA SLAT	
DOGA RIGHE STRIPED SLAT	DOGA QUADRO LEGNO WOODEN SQUARE SLAT
+ 67	+ 97

DOC1171K
1.023
+ 5 %

mc 0,22 - Kg 16

DOC1176K
1.341
+ 5 %

mc 0,22 - Kg 16

OPTIONAL	
DOGA SLAT	
DOGA RIGHE STRIPED SLAT	DOGA QUADRO LEGNO WOODEN SQUARE SLAT
+ 67	+ 97

1 RIBALTA  
1 DROP-DOWN DOOR

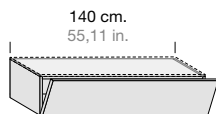

1 RIBALTA  
1 DROP-DOWN DOOR

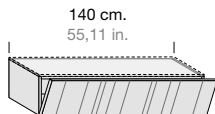

DOGA LEGNO LISCIA  
PLAIN WOODEN SLAT

DOGA LEGNO LISCIA  
PLAIN WOODEN SLAT

OPTIONAL	
DOGA SLAT	
DOGA RIGHE STRIPED SLAT	DOGA QUADRO LEGNO WOODEN SQUARE SLAT
+ 55	+ 80

DOC1191K
1.179
+ 5 %

mc 0,26 - Kg 18

DOC1196K
1.461
+ 5 %

mc 0,26 - Kg 18

OPTIONAL	
DOGA SLAT	
DOGA RIGHE STRIPED SLAT	DOGA QUADRO LEGNO WOODEN SQUARE SLAT
+ 67	+ 97

1 CESTONE  
1 BASKET

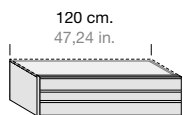

1 RIBALTA  
1 DROP-DOWN DOOR

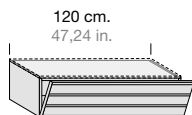

1 CESTONE  
1 BASKET

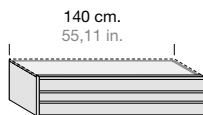

1 RIBALTA  
1 DROP-DOWN DOOR

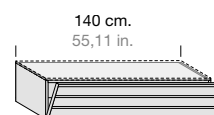

SHC1101K
1.089
+ 5 %

mc 0,18 - Kg 18

SHC1141K
1.112
+ 5 %

mc 0,18 - Kg 15

SHC1111K
1.179
+ 5 %

mc 0,21 - Kg 20

SHC1151K
1.250
+ 5 %

mc 0,21 - Kg 17

# SISTEMA COMPONIBILE - MODULAR SYSTEM

## BASI SOSPESE P. 38 CM.

### SUSPENDED BASE UNITS D. 14,96 IN.

#### BASI H. 35 CM.

BASE UNITS H. 13,77 IN.

A GIORNO  
OPEN

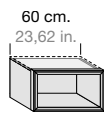

**DOC1522K**

**650**

mc 0,09 – Kg 7

A GIORNO, 1 RIPIANO VETRO  
OPEN ON PLATFORM, 1 GLASS SHELF

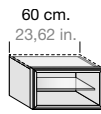

**DOC1572K**

**686**

mc 0,09 – Kg 7

1 CESTONE  
1 BASKET

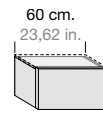

**DOC1341K**

**800**

**+ 5 %**  
mc 0,09 – Kg 12

1 CESTONE  
1 BASKET

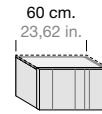

DOGA LEGNO LISCIA  
PLAIN WOODEN SLAT

**DOC1346K**

**1.041**

**+ 5 %**  
mc 0,09 – Kg 12

**OBBLIGATORIO: AGGIUNGERE TOP E PEDANA O ZOCCOLO A TERRA.**  
**COMPULSORY: ADD TOP AND PLATFORM OR PLINTH ON FLOOR.**

CANALETTO

Doghe Multicolor - Multicolor slats

A GIORNO  
OPEN

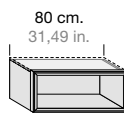

**DOC1532K**

**740**

mc 0,12 – Kg 11

A GIORNO, 1 RIPIANO VETRO  
OPEN ON PLATFORM, 1 GLASS SHELF

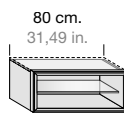

**DOC1582K**

**783**

mc 0,12 – Kg 11

1 CESTONE  
1 BASKET

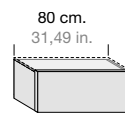

**DOC1361K**

**914**

**+ 5 %**  
mc 0,12 – Kg 16

1 CESTONE  
1 BASKET

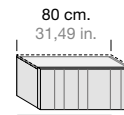

DOGA LEGNO LISCIA  
PLAIN WOODEN SLAT

**DOC1366K**

**1.167**

**+ 5 %**  
mc 0,12 – Kg 16

**OBBLIGATORIO: AGGIUNGERE TOP E PEDANA O ZOCCOLO A TERRA.**  
**COMPULSORY: ADD TOP AND PLATFORM OR PLINTH ON FLOOR.**

CANALETTO

Doghe Multicolor - Multicolor slats

A GIORNO  
OPEN

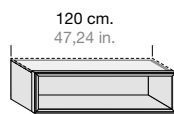

**DOC1542K**

**854**

mc 0,18 – Kg 14

A GIORNO, 1 RIPIANO VETRO  
OPEN ON PLATFORM, 1 GLASS SHELF

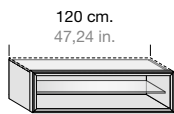

**DOC1592K**

**920**

mc 0,18 – Kg 14

1 CESTONE  
1 BASKET

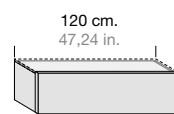

**DOC1381K**

**1.059**

**+ 5 %**  
mc 0,18 – Kg 18

1 CESTONE  
1 BASKET

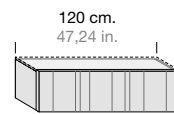

DOGA LEGNO LISCIA  
PLAIN WOODEN SLAT

**DOC1386K**

**1.353**

**+ 5 %**  
mc 0,18 – Kg 18

**OBBLIGATORIO: AGGIUNGERE TOP E PEDANA O ZOCCOLO A TERRA.**  
**COMPULSORY: ADD TOP AND PLATFORM OR PLINTH ON FLOOR.**

CANALETTO

Doghe Multicolor - Multicolor slats

A GIORNO  
OPEN

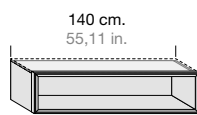

**DOC1552K**

**944**

mc 0,21 – Kg 15

A GIORNO, 1 RIPIANO VETRO  
OPEN ON PLATFORM, 1 GLASS SHELF

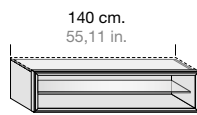

**DOC1602K**

**1.011**

mc 0,21 – Kg 15

A GIORNO, 3 DIVISORI  
OPEN, 3 PARTITIONS

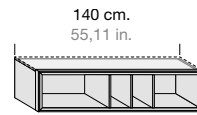

**DOC1612K**

**1.149**

mc 0,21 – Kg 15

1 CESTONE  
1 BASKET

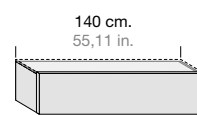

**DOC1401K**

**1.160**

**+ 5 %**  
mc 0,21 – Kg 20

**OBBLIGATORIO: AGGIUNGERE TOP E PEDANA O ZOCCOLO A TERRA.**  
**COMPULSORY: ADD TOP AND PLATFORM OR PLINTH ON FLOOR.**

CANALETTO

Doghe Multicolor - Multicolor slats

## BASI SOSPESE P. 38 CM. SUSPENDED BASE UNITS D. 14,96 IN.

1 RIBALTA  
1 DROP-DOWN DOOR

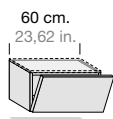

1 RIBALTA  
1 DROP-DOWN DOOR

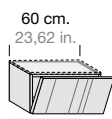

DOGA LEGNO LISCIA  
PLAIN WOODEN SLAT

DOC1446K

1.064  
+ 5 %

mc 0,09 – Kg 10

DOC1441K

813  
+ 5 %

mc 0,09 – Kg 10

OPTIONAL

DOGA SLAT  
DOGA RIGHE STRIPED SLAT DOGA QUADRO LEGNO WOODEN SQUARE SLAT

+ 67

+ 97

OPTIONAL

DOGA SLAT  
DOGA RIGHE STRIPED SLAT DOGA QUADRO LEGNO WOODEN SQUARE SLAT

+ 67

+ 97

1 RIBALTA  
1 DROP-DOWN DOOR

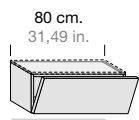

1 RIBALTA  
1 DROP-DOWN DOOR

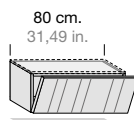

DOGA LEGNO LISCIA  
PLAIN WOODEN SLAT

DOC1466K

1.184  
+ 5 %

mc 0,12 – Kg 12

DOC1461K

903  
+ 5 %

mc 0,12 – Kg 12

OPTIONAL

DOGA SLAT  
DOGA RIGHE STRIPED SLAT DOGA QUADRO LEGNO WOODEN SQUARE SLAT

+ 67

+ 97

OPTIONAL

DOGA SLAT  
DOGA RIGHE STRIPED SLAT DOGA QUADRO LEGNO WOODEN SQUARE SLAT

+ 67

+ 97

1 RIBALTA  
1 DROP-DOWN DOOR

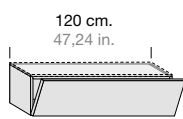

1 RIBALTA  
1 DROP-DOWN DOOR

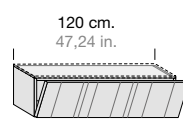

DOGA LEGNO LISCIA  
PLAIN WOODEN SLAT

DOC1486K

1.341  
+ 5 %

mc 0,18 – Kg 15

DOC1481K

1.023  
+ 5 %

mc 0,18 – Kg 15

OPTIONAL

DOGA SLAT  
DOGA RIGHE STRIPED SLAT DOGA QUADRO LEGNO WOODEN SQUARE SLAT

+ 67

+ 97

OPTIONAL

DOGA SLAT  
DOGA RIGHE STRIPED SLAT DOGA QUADRO LEGNO WOODEN SQUARE SLAT

+ 67

+ 97

1 CESTONE  
1 BASKET

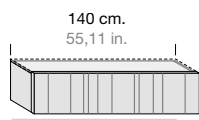

1 RIBALTA  
1 DROP-DOWN DOOR

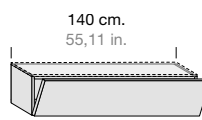

1 RIBALTA  
1 DROP-DOWN DOOR

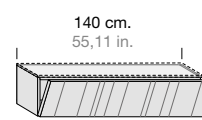

DOGA LEGNO LISCIA  
PLAIN WOODEN SLAT

DOC1406K

1.419  
+ 5 %

mc 0,21 – Kg 20

OPTIONAL

DOGA SLAT  
DOGA RIGHE STRIPED SLAT DOGA QUADRO LEGNO WOODEN SQUARE SLAT

+ 67

+ 97

DOC1501K

1.173  
+ 5 %

mc 0,21 – Kg 17

DOGA LEGNO LISCIA  
PLAIN WOODEN SLAT

DOC1506K

1.456  
+ 5 %

mc 0,21 – Kg 17

OPTIONAL

DOGA SLAT  
DOGA RIGHE STRIPED SLAT DOGA QUADRO LEGNO WOODEN SQUARE SLAT

+ 67

+ 97

OPTIONAL  
OPTIONAL

KIT SPORTELLINO PASSACAVI  
+ BORCHIA  
KIT FOR CABLE MANAGEMENT HOLE  
+ COVER

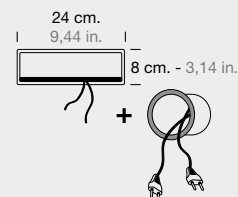

ZZZFE22005

133

# SISTEMA COMPONIBILE - MODULAR SYSTEM

## BASI SOSPESSE P. 38 CM.

### SUSPENDED BASE UNITS D. 14,96 IN.

#### SHANGHAI BASI H. 35 CM.

#### SHANGHAI BASE UNITS H. 13,77 IN.

1 CESTONE  
1 BASKET

1 RIBALTA  
1 DROP-DOWN DOOR

1 CESTONE  
1 BASKET

1 RIBALTA  
1 DROP-DOWN DOOR

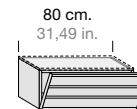
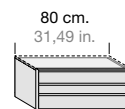
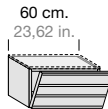
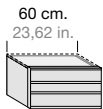

**OBBLIGATORIO: AGGIUNGERE TOP E PEDANA O ZOCCOLO A TERRA.**  
**COMPULSORY: ADD TOP AND PLATFORM OR PLINTH ON FLOOR.**

SHC1161K

SHC1201K

SHC1171K

SHC1211K

CANALETTO

Bicolore - Bicolor

879

+ 5 %

mc 0,09 - Kg 12

914

+ 5 %

mc 0,09 - Kg 10

968

+ 5 %

mc 0,12 - Kg 16

1.004

+ 5 %

mc 0,12 - Kg 8

## BASI SOSPESSE P. 48 CM.

### SUSPENDED

### BASE UNITS D. 18,89 IN.

#### BASI H. 35 CM.

#### BASE UNITS H. 13,77 IN.

A GIORNO  
OPEN

A GIORNO, 1 RIPIANO VETRO  
OPEN ON PLATFORM, 1 GLASS SHELF

1 CESTONE  
1 BASKET

1 CESTONE  
1 BASKET

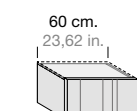
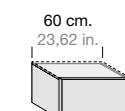
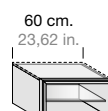
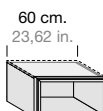

**OBBLIGATORIO: AGGIUNGERE TOP E PEDANA O ZOCCOLO A TERRA.**  
**COMPULSORY: ADD TOP AND PLATFORM OR PLINTH ON FLOOR.**

DOC1222K

DOC1272K

DOC1031K

DOGA LEGNO LISCIA  
PLAIN WOODEN SLAT

DOC1036K

CANALETTO

Doghe Multicolor - Multicolor slats

662

mc 0,11 - Kg 8

698

mc 0,11 - Kg 8

813

+ 5 %

mc 0,11 - Kg 15

1.052

+ 5 %

mc 0,11 - Kg 15

A GIORNO  
OPEN

A GIORNO, 1 RIPIANO VETRO  
OPEN ON PLATFORM, 1 GLASS SHELF

1 CESTONE  
1 BASKET

1 CESTONE  
1 BASKET

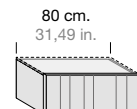
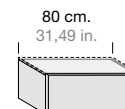
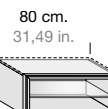
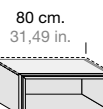

**OBBLIGATORIO: AGGIUNGERE TOP E PEDANA O ZOCCOLO A TERRA.**  
**COMPULSORY: ADD TOP AND PLATFORM OR PLINTH ON FLOOR.**

DOC1232K

DOC1282K

DOC1051K

DOGA LEGNO LISCIA  
PLAIN WOODEN SLAT

DOC1056K

CANALETTO

Doghe Multicolor - Multicolor slats

746

mc 0,15 - Kg 10

788

mc 0,15 - Kg 10

920

+ 5 %

mc 0,15 - Kg 18

1.173

+ 5 %

mc 0,15 - Kg 18

A GIORNO  
OPEN

A GIORNO, 1 RIPIANO VETRO  
OPEN ON PLATFORM, 1 GLASS SHELF

1 CESTONE  
1 BASKET

1 CESTONE  
1 BASKET

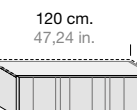
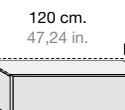
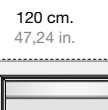
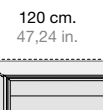

**OBBLIGATORIO: AGGIUNGERE TOP E PEDANA O ZOCCOLO A TERRA.**  
**COMPULSORY: ADD TOP AND PLATFORM OR PLINTH ON FLOOR.**

DOC1242K

DOC1292K

DOC1071K

DOGA LEGNO LISCIA  
PLAIN WOODEN SLAT

DOC1076K

CANALETTO

Doghe Multicolor - Multicolor slats

866

mc 0,22 - Kg 14

932

mc 0,22 - Kg 14

1.070

+ 5 %

mc 0,22 - Kg 21

1.365

+ 5 %

mc 0,22 - Kg 21



1 CESTONE  
1 BASKET

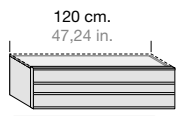

120 cm.  
47,24 in.

**SHC1181K**

**1.089**  
**+ 5 %**

mc 0,18 – Kg 18

1 RIBALTA  
1 DROP-DOWN DOOR

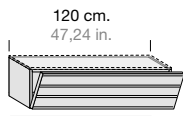

120 cm.  
47,24 in.

**SHC1221K**

**1.100**  
**+ 5 %**

mc 0,18 – Kg 15

1 CESTONE  
1 BASKET

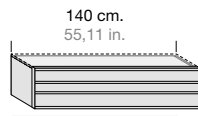

140 cm.  
55,11 in.

**SHC1191K**

**1.179**  
**+ 5 %**

mc 0,21 – Kg 20

1 RIBALTA  
1 DROP-DOWN DOOR

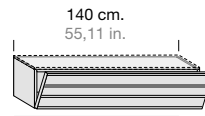

140 cm.  
55,11 in.

**SHC1231K**

**1.240**  
**+ 5 %**

mc 0,21 – Kg 17

1 RIBALTA  
1 DROP-DOWN DOOR

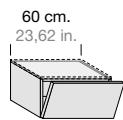

60 cm.  
23,62 in.

**OPTIONAL**

DOGA SLAT

DOGA RIGHE  
STRIPED SLAT

DOGA QUADRO LEGNO  
WOODEN SQUARE SLAT

**+ 67**

**+ 97**

**DOC1141K**

**823**

**+ 5 %**

mc 0,11 – Kg 11

1 RIBALTA  
1 DROP-DOWN DOOR

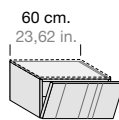

60 cm.  
23,62 in.

DOGA LEGNO LISCIA  
PLAIN WOODEN SLAT

**DOC1146K**

**1.077**

**+ 5 %**

mc 0,11 – Kg 11

**OPTIONAL**

DOGA SLAT

DOGA RIGHE  
STRIPED SLAT

DOGA QUADRO LEGNO  
WOODEN SQUARE SLAT

**+ 67**

**+ 97**

1 RIBALTA  
1 DROP-DOWN DOOR

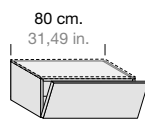

80 cm.  
31,49 in.

**OPTIONAL**

DOGA SLAT

DOGA RIGHE  
STRIPED SLAT

DOGA QUADRO LEGNO  
WOODEN SQUARE SLAT

**+ 67**

**+ 97**

**DOC1161K**

**909**

**+ 5 %**

mc 0,15 – Kg 13

1 RIBALTA  
1 DROP-DOWN DOOR

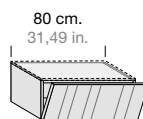

80 cm.  
31,49 in.

DOGA LEGNO LISCIA  
PLAIN WOODEN SLAT

**DOC1166K**

**1.191**

**+ 5 %**

mc 0,15 – Kg 13

**OPTIONAL**

DOGA SLAT

DOGA RIGHE  
STRIPED SLAT

DOGA QUADRO LEGNO  
WOODEN SQUARE SLAT

**+ 67**

**+ 97**

1 RIBALTA  
1 DROP-DOWN DOOR

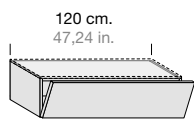

120 cm.  
47,24 in.

**OPTIONAL**

DOGA SLAT

DOGA RIGHE  
STRIPED SLAT

DOGA QUADRO LEGNO  
WOODEN SQUARE SLAT

**+ 67**

**+ 97**

**DOC1181K**

**1.034**

**+ 5 %**

mc 0,22 – Kg 16

1 RIBALTA  
1 DROP-DOWN DOOR

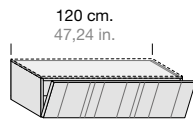

120 cm.  
47,24 in.

DOGA LEGNO LISCIA  
PLAIN WOODEN SLAT

**DOC1186K**

**1.353**

**+ 5 %**

mc 0,22 – Kg 16

**OPTIONAL**

DOGA SLAT

DOGA RIGHE  
STRIPED SLAT

DOGA QUADRO LEGNO  
WOODEN SQUARE SLAT

**+ 67**

**+ 97**

# SISTEMA COMPONIBILE - MODULAR SYSTEM

## BASI SOSPESE P. 48 CM.

### SUSPENDED BASE UNITS D. 18,89 IN.

#### BASI H. 35 CM.

BASE UNITS H. 13,77 IN.

A GIORNO  
OPEN

A GIORNO, 1 RIPIANO VETRO  
OPEN ON PLATFORM, 1 GLASS SHELF

A GIORNO, 3 DIVISORI  
OPEN, 3 PARTITIONS

1 CESTONE  
1 BASKET

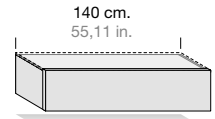
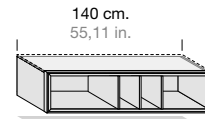
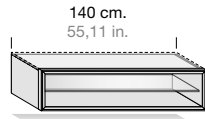
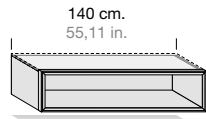

**OBBLIGATORIO: AGGIUNGERE TOP E PEDANA O ZOCCOLO A TERRA.**  
**COMPULSORY: ADD TOP AND PLATFORM OR PLINTH ON FLOOR.**

**DOC1252K**

**DOC1302K**

**DOC1622K**

**DOC1091K**

CANALETTO

Doghe Multicolor - Multicolor slats

**951**

**1.023**

**1.167**

**1.179**

**+ 5 %**

mc 0,26 - Kg 18

mc 0,26 - Kg 18

mc 0,21 - Kg 15

mc 0,26 - Kg 23

#### SHANGHAI BASI H. 35 CM.

SHANGHAI  
BASE UNITS H. 13,77 IN.

1 CESTONE  
1 BASKET

1 RIBALTA  
1 DROP-DOWN DOOR

1 CESTONE  
1 BASKET

1 RIBALTA  
1 DROP-DOWN DOOR

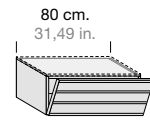
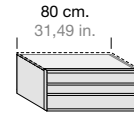
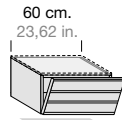
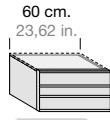

**OBBLIGATORIO: AGGIUNGERE TOP E PEDANA O ZOCCOLO A TERRA.**  
**COMPULSORY: ADD TOP AND PLATFORM OR PLINTH ON FLOOR.**

**SHC1241K**

**SHC1281K**

**SHC1251K**

**SHC1291K**

CANALETTO

Bicolore - Bicolor

**890**

**938**

**981**

**1.016**

**+ 5 %**

**+ 5 %**

**+ 5 %**

**+ 5 %**

mc 0,09 - Kg 12

mc 0,09 - Kg 10

mc 0,12 - Kg 16

mc 0,12 - Kg 8

1 CESTONE  
1 BASKET

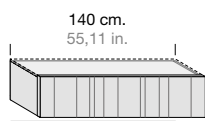

DOGA LEGNO LISCIA  
PLAIN WOODEN SLAT

DOC1096K	OPTIONAL	
	DOGA SLAT	
	DOGA RIGHE STRIPED SLAT	DOGA QUADRO LEGNO WOODEN SQUARE SLAT
<b>1.443</b>	<b>+ 67</b>	<b>+ 97</b>
<b>+ 5 %</b>		
mc 0,26 - Kg 23		

1 RIBALTA  
1 DROP-DOWN DOOR

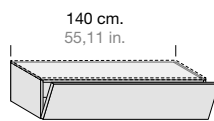

DOC1201K
<b>1.191</b>
<b>+ 5 %</b>
mc 0,26 - Kg 18

1 RIBALTA  
1 DROP-DOWN DOOR

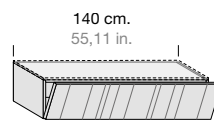

DOGA LEGNO LISCIA  
PLAIN WOODEN SLAT

DOC1206K	OPTIONAL	
	DOGA SLAT	
	DOGA RIGHE STRIPED SLAT	DOGA QUADRO LEGNO WOODEN SQUARE SLAT
<b>1.509</b>	<b>+ 67</b>	<b>+ 97</b>
<b>+ 5 %</b>		
mc 0,26 - Kg 18		

1 CESTONE  
1 BASKET

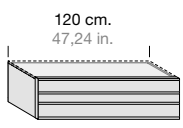

SHC1261K
<b>1.100</b>
<b>+ 5 %</b>
mc 0,18 - Kg 18

1 RIBALTA  
1 DROP-DOWN DOOR

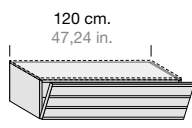

SHC1301K
<b>1.125</b>
<b>+ 5 %</b>
mc 0,18 - Kg 15

1 CESTONE  
1 BASKET

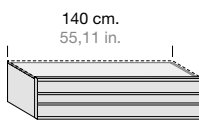

SHC1271K
<b>1.191</b>
<b>+ 5 %</b>
mc 0,21 - Kg 20

1 RIBALTA  
1 DROP-DOWN DOOR

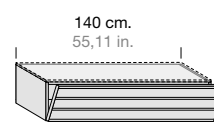

SHC1311K
<b>1.263</b>
<b>+ 5 %</b>
mc 0,21 - Kg 17

OPTIONAL  
OPTIONAL

KIT SPORTELLI PASSACAVI  
+ BORCHIA  
KIT FOR CABLE MANAGEMENT HOLE  
+ COVER

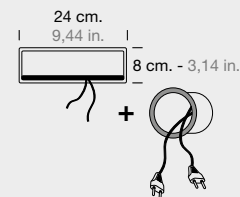

ZZZFE22005

133

# DOMINO SISTEMA COMPONIBILE - MODULAR SYSTEM

## PENSILI ORIZZONTALI P. 38 CM.

### HORIZONTAL WALL UNITS D. 14,96 IN.

**PENSILI H. 35 CM.**  
WALL UNITS H. 13,77 IN.

1 ANTA RIBALTA  
1 DROP-DOWN DOOR

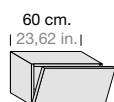

DOC2051K	
CANALETTO	<b>783</b>
Multicolor	<b>+ 10 %</b>
mc 0,09 – Kg 12	

1 ANTA VASISTAS  
1 LIFT-UP DOOR

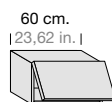

DOC2071K	
CANALETTO	<b>735</b>
Multicolor	<b>+ 5 %</b>
mc 0,09 – Kg 12	

1 ANTA VETRO RIBALTA  
1 DROP-DOWN GLASS DOOR



VETRO TRASPARENTE  
TRANSPARENT GLASS

DOC2041K	
CANALETTO	<b>896</b>
Multicolor	<b>+ 5 %</b>
mc 0,09 – Kg 12	

OPTIONAL	
VETRO GLASS	
TOP SOL	FUMÉ SMOKED
<b>+ 37</b>	<b>+ 19</b>

1 ANTA DOGATA VASISTAS  
1 SLATTED LIFT-UP DOOR

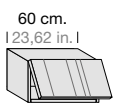

DOGA LEGNO LISCIA  
PLAIN WOODEN SLAT

DOC2076K	
CANALETTO	<b>975</b>
Multicolor	<b>+ 5 %</b>
mc 0,09 – Kg 12	

OPTIONAL	
DOGA SLAT	
DOGA RIGHE STRIPED SLAT	DOGA QUADRO LEGNO WOODEN SQUARE SLAT
<b>+ 67</b>	<b>+ 97</b>

1 ANTA LEGNO RIBALTA  
1 DROP-DOWN DOOR

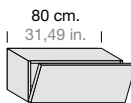

DOC2091K	
CANALETTO	<b>890</b>
Multicolor	<b>+ 5 %</b>
mc 0,12 – Kg 15	

1 ANTA LEGNO VASISTAS  
1 LIFT-UP DOOR

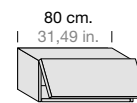

DOC2111K	
CANALETTO	<b>884</b>
Multicolor	<b>+ 5 %</b>
mc 0,12 – Kg 15	

1 ANTA DOGATA RIBALTA  
1 SLATTED DROP-DOWN DOOR

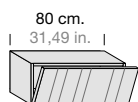

DOGA LEGNO LISCIA  
PLAIN WOODEN SLAT

DOC2096K	
CANALETTO	<b>1.167</b>
Multicolor	<b>+ 5 %</b>
mc 0,12 – Kg 15	

OPTIONAL	
DOGA SLAT	
DOGA RIGHE STRIPED SLAT	DOGA QUADRO LEGNO WOODEN SQUARE SLAT
<b>+ 67</b>	<b>+ 97</b>

1 ANTA DOGATA VASISTAS  
1 SLATTED LIFT-UP DOOR

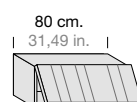

DOGA LEGNO LISCIA  
PLAIN WOODEN SLAT

DOC2116K	
CANALETTO	<b>1.160</b>
Multicolor	<b>+ 5 %</b>
mc 0,12 – Kg 15	

OPTIONAL	
DOGA SLAT	
DOGA RIGHE STRIPED SLAT	DOGA QUADRO LEGNO WOODEN SQUARE SLAT
<b>+ 67</b>	<b>+ 97</b>

1 ANTA VETRO VASISTAS  
1 GLASS LIFT-UP DOOR

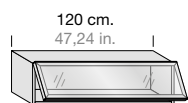

VETRO TRASPARENTE  
TRANSPARENT GLASS

DOC2141K	
CANALETTO	<b>1.197</b>
Multicolor	<b>+ 5 %</b>
mc 0,18 – Kg 21	

OPTIONAL	
VETRO GLASS	
TOP SOL	FUMÉ SMOKED
<b>+ 79</b>	<b>+ 30</b>

1 ANTA DOGATA RIBALTA  
1 SLATTED DROP-DOWN DOOR

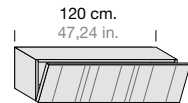

DOGA LEGNO LISCIA  
PLAIN WOODEN SLAT

DOC2136K	
CANALETTO	<b>1.419</b>
Multicolor	<b>+ 5 %</b>
mc 0,18 – Kg 21	

OPTIONAL	
DOGA SLAT	
DOGA RIGHE STRIPED SLAT	DOGA QUADRO LEGNO WOODEN SQUARE SLAT
<b>+ 67</b>	<b>+ 97</b>

**1 ANTA VETRO VASISTAS**  
1 GLASS LIFT-UP DOOR



**VETRO TRASPARENTE**  
TRANSPARENT GLASS

DOC2061K	OPTIONAL	
	VETRO GLASS	
	TOP SOL	FUMÉ SMOKED
<b>848</b>	<b>+ 37</b>	<b>+ 19</b>
<b>+ 5 %</b>		
mc 0,09 – Kg 12		

**1 ANTA DOGATA RIBALTA**  
1 SLATTED DROP-DOWN DOOR



**DOGA LEGNO LISCIA**  
PLAIN WOODEN SLAT

DOC2056K	OPTIONAL	
	DOGA SLAT	
	DOGA RIGHE STRIPED SLAT	DOGA QUADRO LEGNO WOODEN SQUARE SLAT
<b>1.016</b>	<b>+ 67</b>	<b>+ 97</b>
<b>+ 5 %</b>		
mc 0,09 – Kg 12		

**1 ANTA VETRO RIBALTA**  
1 DROP-DOWN GLASS DOOR

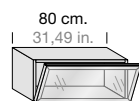

**VETRO TRASPARENTE**  
TRANSPARENT GLASS

DOC2081K	OPTIONAL	
	VETRO GLASS	
	TOP SOL	FUMÉ SMOKED
<b>981</b>	<b>+ 54</b>	<b>+ 24</b>
<b>+ 5 %</b>		
mc 0,12 – Kg 15		

**1 ANTA VETRO VASISTAS**  
1 GLASS LIFT-UP DOOR

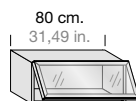

**VETRO TRASPARENTE**  
TRANSPARENT GLASS

DOC2101K	OPTIONAL	
	VETRO GLASS	
	TOP SOL	FUMÉ SMOKED
<b>975</b>	<b>+ 54</b>	<b>+ 24</b>
<b>+ 5 %</b>		
mc 0,12 – Kg 15		

**1 ANTA LEGNO RIBALTA**  
1 DROP-DOWN DOOR

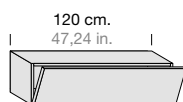

DOC2131K
<b>1.052</b>
<b>+ 5 %</b>
mc 0,18 – Kg 21

**1 ANTA LEGNO VASISTAS**  
1 LIFT-UP DOOR

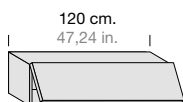

DOC2151K
<b>1.047</b>
<b>+ 5 %</b>
mc 0,18 – Kg 21

**1 ANTA VETRO RIBALTA**  
1 DROP-DOWN GLASS DOOR

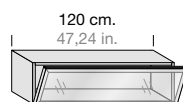

**VETRO TRASPARENTE**  
TRANSPARENT GLASS

DOC2121K	OPTIONAL	
	VETRO GLASS	
	TOP SOL	FUMÉ SMOKED
<b>1.209</b>	<b>+ 79</b>	<b>+ 30</b>
<b>+ 5 %</b>		
mc 0,18 – Kg 21		

**1 ANTA DOGATA VASISTAS**  
1 SLATTED LIFT-UP DOOR

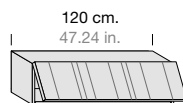

**DOGA LEGNO LISCIA**  
PLAIN WOODEN SLAT

DOC2156K	OPTIONAL	
	DOGA SLAT	
	DOGA RIGHE STRIPED SLAT	DOGA QUADRO LEGNO WOODEN SQUARE SLAT
<b>1.413</b>	<b>+ 67</b>	<b>+ 97</b>
<b>+ 5 %</b>		
mc 0,18 – Kg 21		

**1 ANTA LEGNO RIBALTA**  
1 DROP-DOWN DOOR

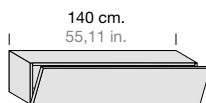

DOC2171K
<b>1.197</b>
<b>+ 5 %</b>
mc 0,21 – Kg 24

**1 ANTA LEGNO VASISTAS**  
1 LIFT-UP DOOR



DOC2191K
<b>1.119</b>
<b>+ 5 %</b>
mc 0,21 – Kg 24

**OPTIONAL**  
**OPTIONAL**

**BARRA LED A BASSO CONSUMO**  
**ACCENSIONE TOUCH IN ALLUMINIO**  
**DA POSIZIONARE SUL COPERCHIO**  
**DEL PENSILE**

**LOW CONSUMPTION ALUMINIUM LED**  
**BAR WITH TOUCH SWITCH ON**  
**TO ARRANGE ON WALL UNIT TOP**

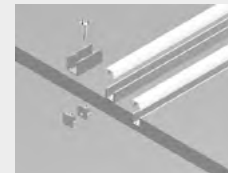

**ZZZFE22020**

L. 40 cm. w. 15,74 in.

**163**

**ZZZFE22024**

L. 60 cm. w. 23,62 in.

**175**

**ZZZFE22025**

L. 80 cm. w. 31,49 in.

**187**

**ZZZFE22026**

L. 120 cm. w. 47,24 in.

**235**

**ZZZFE22027**

L. 140 cm. w. 55,11 in.

**253**

**ALIMENTATORE**  
**POWER SUPPLY**



**ZZZFE22002**

**67**

**COLLEGAMENTO**  
**A CARICO DEL CLIENTE**  
**CONNECTIONS**  
**TO BE MADE BY THE CUSTOMER.**

# DOMINO SISTEMA COMPONIBILE - MODULAR SYSTEM

## PENSILI ORIZZONTALI P. 38 CM.

### HORIZONTAL WALL UNITS D. 14,96 IN.

**PENSILI H. 35 CM.**  
WALL UNITS H. 13,77 IN.

1 ANTA VETRO RIBALTA  
1 DROP-DOWN GLASS DOOR

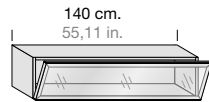

1 ANTA VETRO VASISTAS  
1 GLASS LIFT-UP DOOR



VETRO TRASPARENTE  
TRANSPARENT GLASS

DOC2161K	OPTIONAL	
	VETRO GLASS	
	TOP SOL	FUMÉ SMOKED
<b>1.401</b>	<b>+ 85</b>	<b>+ 37</b>
<b>+ 5 %</b>		
mc 0,21 – Kg 24		

VETRO TRASPARENTE  
TRANSPARENT GLASS

DOC2181K	OPTIONAL	
	VETRO GLASS	
	TOP SOL	FUMÉ SMOKED
<b>1.323</b>	<b>+ 85</b>	<b>+ 37</b>
<b>+ 5 %</b>		
mc 0,21 – Kg 24		

CANALETTO  
Multicolor

**PENSILI A GIORNO H. 35 CM.**  
**CON CORNICE MASSELLO**  
OPEN WALL UNITS  
H. 13,77 IN.  
WITH SOLID FRAME

A GIORNO  
OPEN

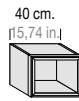

A GIORNO  
OPEN

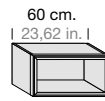

A GIORNO  
OPEN

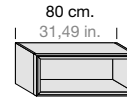

A GIORNO  
OPEN

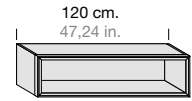

DOC2751K
<b>524</b>
mc 0,06 – Kg 5

DOC2761K
<b>632</b>
mc 0,09 – Kg 7

DOC2771K
<b>722</b>
mc 0,12 – Kg 11

DOC2781K
<b>836</b>
mc 0,18 – Kg 14

CANALETTO

A GIORNO, 1 RIPIANO VETRO  
OPEN, 1 GLASS SHELF



A GIORNO, 1 RIPIANO VETRO  
OPEN, 1 GLASS SHELF

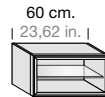

A GIORNO, 1 RIPIANO VETRO  
OPEN, 1 GLASS SHELF

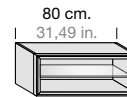

A GIORNO, 1 RIPIANO VETRO  
OPEN, 1 GLASS SHELF



DOC2752K
<b>547</b>
mc 0,06 – Kg 5

DOC2762K
<b>662</b>
mc 0,09 – Kg 7

DOC2772K
<b>758</b>
mc 0,12 – Kg 11

DOC2782K
<b>903</b>
mc 0,18 – Kg 15

CANALETTO

**PENSILI H. 35 CM.**  
WALL UNITS H. 13,77 IN.

1 ANTA LEGNO  
1 WOODEN DOOR

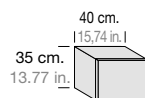

1 ANTA VETRO  
1 GLASS DOOR

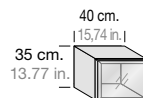

1 ANTA DOGATA  
1 SLATTED DOOR

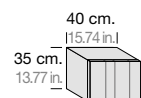

DX / RH  
SX / LH

DOC2481K DOC2581K
<b>625</b>
<b>+ 5 %</b>
mc 0,06 – Kg 9

VETRO TRASPARENTE  
TRANSPARENT GLASS

DOC2471K DOC2571K	OPTIONAL	
	VETRO GLASS	
	TOP SOL	FUMÉ SMOKED
<b>740</b>	<b>+ 30</b>	<b>+ 19</b>
<b>+ 5 %</b>		
mc 0,06 – Kg 9		

DOGA LEGNO LISCIA  
PLAIN WOODEN SLAT

DOC2486K DOC2586K
<b>842</b>
<b>+ 5 %</b>
mc 0,06 – Kg 9

CANALETTO  
Multicolor

**1 ANTA DOGATA RIBALTA**  
1 SLATTED DROP-DOWN DOOR

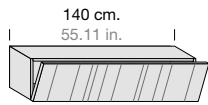

**DOGA LEGNO LISCIA**  
PLAIN WOODEN SLAT

DOC2176K	OPTIONAL	
	DOGA SLAT	
	DOGA RIGHE STRIPED SLAT	DOGA QUADRO LEGNO WOODEN SQUARE SLAT
<b>1.564</b>	<b>+ 67</b>	<b>+ 97</b>
<b>+ 5 %</b>		
mc 0,21 – Kg 24		

**1 ANTA DOGATA VASISTAS**  
1 SLATTED LIFT-UP DOOR

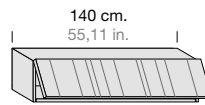

**DOGA LEGNO LISCIA**  
PLAIN WOODEN SLAT

DOC2196K	OPTIONAL	
	DOGA SLAT	
	DOGA RIGHE STRIPED SLAT	DOGA QUADRO LEGNO WOODEN SQUARE SLAT
<b>1.473</b>	<b>+ 67</b>	<b>+ 97</b>
<b>+ 5 %</b>		
mc 0,21 – Kg 24		

**A GIORNO**  
OPEN

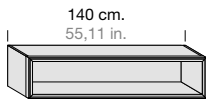

DOC2791K			
<b>914</b>			
mc 0,21 – Kg 15			

**A GIORNO, 1 RIPIANO VETRO**  
OPEN, 1 GLASS SHELF



DOC2792K			
<b>981</b>			
mc 0,21 – Kg 16			

**OPTIONAL**  
**OPTIONAL**

**BARRA LED A BASSO CONSUMO**  
**ACCENSIONE TOUCH IN ALLUMINIO**  
**DA POSIZIONARE SUL COPERCHIO**  
**DEL PENSILE**

**LOW CONSUMPTION ALUMINIUM LED**  
**BAR WITH TOUCH SWITCH ON**  
**TO ARRANGE ON WALL UNIT TOP**

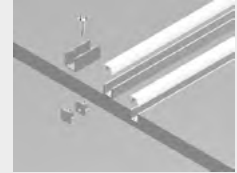

**ZZZFE22020**

L. 40 cm. W. 15,74 in.

**163**

**ZZZFE22024**

L. 60 cm. W. 23,62 in.

**175**

**ZZZFE22025**

L. 80 cm. W. 31,49 in.

**187**

**ZZZFE22026**

L. 120 cm. W. 47,24 in.

**235**

**ZZZFE22027**

L. 140 cm. W. 55,11 in.

**253**

**ALIMENTATORE**  
**POWER SUPPLY**



**ZZZFE22002**

**67**

**COLLEGAMENTO**  
**A CARICO DEL CLIENTE**  
**CONNECTIONS**  
**TO BE MADE BY THE CUSTOMER.**

# DOMINO SISTEMA COMPONIBILE - MODULAR SYSTEM

## PENSILI ORIZZONTALI P. 38 CM.

### HORIZONTAL WALL UNITS D. 14,96 IN.

**PENSILI H. 60 CM.**  
WALL UNITS H. 23,62 IN.

1 ANTA LEGNO, 1 RIPIANO VETRO  
1 WOODEN DOOR, 1 GLASS SHELF

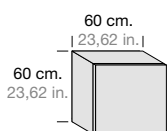

1 ANTA VETRO, 1 RIPIANO VETRO  
1 GLASS DOOR, 1 GLASS SHELF

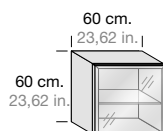

DX / RH  
SX / LH

**DOC2211K**  
**DOC2311K**

VETRO TRASPARENTE  
TRANSPARENT GLASS

**DOC2201K**  
**DOC2301K**

**OPTIONAL**

VETRO GLASS

TOP SOL

FUMÉ  
SMOKED

CANALETTO

**848**

**1.011**

**+ 54**

**+ 24**

Doghe Multicolor - Multicolor slats

**+ 5 %**

**+ 5 %**

mc 0,15 - Kg 20

mc 0,15 - Kg 20

2 ANTE LEGNO, 2 RIPIANI VETRO  
2 WOODEN DOORS, 2 GLASS SHELVES

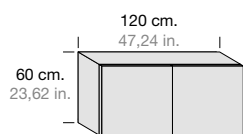

2 ANTE VETRO, 2 RIPIANI VETRO  
2 GLASS SHELVES 1 GLASS SHELF

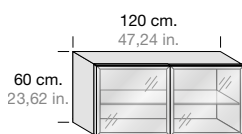

**DOC2231K**

**DOC2221K**

**OPTIONAL**

VETRO GLASS

TOP SOL

FUMÉ  
SMOKED

CANALETTO

**1.479**

**1.773**

**+ 102**

**+ 49**

Doghe Multicolor - Multicolor slats

**+ 5 %**

**+ 5 %**

mc 0,30 - Kg 34

mc 0,30 - Kg 34

**PENSILI H. 70 CM.**  
WALL UNITS H. 27,55 IN.

1 ANTA LEGNO, 1 RIPIANO VETRO  
1 WOODEN DOOR, 1 GLASS SHELF

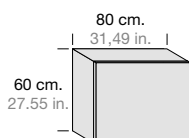

1 ANTA VETRO, 1 RIPIANO VETRO  
1 GLASS DOOR, 1 GLASS SHELF

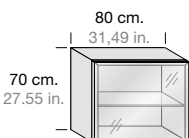

2 ANTE LEGNO, 2 RIPIANI VETRO  
2 WOODEN DOORS, 2 GLASS SHELVES

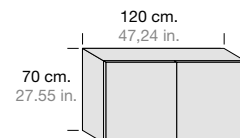

DX / RH  
SX / LH

**DOC2441K**  
**DOC2541K**

VETRO TRASPARENTE  
TRANSPARENT GLASS

**DOC2431K**  
**DOC2531K**

**OPTIONAL**

VETRO GLASS

TOP SOL

FUMÉ  
SMOKED

CANALETTO

**981**

**1.250**

**+ 79**

**+ 37**

Doghe Multicolor - Multicolor slats

**+ 5 %**

**+ 5 %**

mc 0,25 - Kg 30

mc 0,25 - Kg 30

**1.569**

**+ 5 %**

mc 0,38 - Kg 43



1 ANTA DOGATA, 1 RIPIANO VETRO  
1 SLATTED DOOR, 1 GLASS SHELF

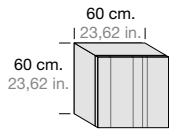

DOGA LEGNO LISCIA  
PLAIN WOODEN SLAT

DOC2216K DOC2316K	OPTIONAL			
	DOGA SLAT			
	DOGA RIGHE STRIPED SLAT	DOGA QUADRO LEGNO WOODEN SQUARE SLAT		
<b>1.215</b>	<b>+ 79</b>	<b>+ 110</b>		
<b>+ 5 %</b>				
mc 0,15 – Kg 20				

2 ANTE DOGATE, 2 RIPIANI VETRO  
2 SLATTED DOORS, 2 GLASS SHELVES

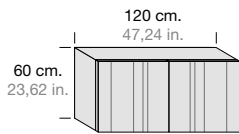

DOGA LEGNO LISCIA  
PLAIN WOODEN SLAT

DOC2236K	OPTIONAL			
	DOGA SLAT			
	DOGA RIGHE STRIPED SLAT	DOGA QUADRO LEGNO WOODEN SQUARE SLAT		
<b>2.146</b>	<b>+ 79</b>	<b>+ 110</b>		
<b>+ 5 %</b>				
mc 0,30 – Kg 34				

2 ANTE DOGATE, 2 RIPIANI VETRO  
2 SLATTED DOORS, 2 GLASS SHELVES

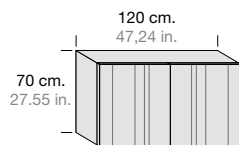

DOGA LEGNO LISCIA  
PLAIN WOODEN SLAT

DOC2616K	OPTIONAL			
	DOGA SLAT			
	DOGA RIGHE STRIPED SLAT	DOGA QUADRO LEGNO WOODEN SQUARE SLAT		
<b>1.888</b>	<b>+ 79</b>	<b>+ 110</b>		
<b>+ 5 %</b>				
mc 0,38 – Kg 43				

2 ANTE VETRO, 2 RIPIANI VETRO  
2 GLASS SHELVES 1 GLASS SHELF

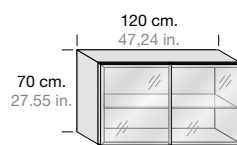

VETRO TRASPARENTE  
TRANSPARENT GLASS

DOC2601K	OPTIONAL			
	VETRO GLASS			
	TOP SOL	FUMÉ SMOKED		
<b>1.888</b>	<b>+ 158</b>	<b>+ 72</b>		
<b>+ 5 %</b>				
mc 0,38 – Kg 43				

OPTIONAL  
OPTIONAL

BARRA LED A BASSO CONSUMO  
ACCENSIONE TOUCH IN ALLUMINIO  
DA POSIZIONARE SUL COPERCHIO  
DEL PENSILE

LOW CONSUMPTION ALUMINIUM LED  
BAR WITH TOUCH SWITCH ON  
TO ARRANGE ON WALL UNIT TOP

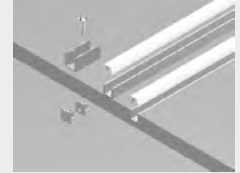

ZZZFE22020

L. 40 cm. w. 15,74 in.

163

ZZZFE22024

L. 60 cm. w. 23,62 in.

175

ZZZFE22025

L. 80 cm. w. 31,49 in.

187

ZZZFE22026

L. 120 cm. w. 47,24 in.

235

ZZZFE22027

L. 140 cm. w. 55,11 in.

253

ALIMENTATORE  
POWER SUPPLY



ZZZFE22002

67

COLLEGAMENTO  
A CARICO DEL CLIENTE  
CONNECTIONS  
TO BE MADE BY THE CUSTOMER.

# DOMINO SISTEMA COMPONIBILE - MODULAR SYSTEM

## PENSILI VERTICALI P. 38 CM.

### VERTICAL WALL UNITS D. 14,96 IN.

**PENSILI H. 60 IN.**  
WALL UNITS H. 23,62 IN.

1 ANTA LEGNO, 1 RIPIANO VETRO  
1 WOODEN DOOR, 1 GLASS SHELF

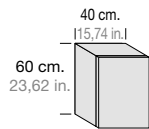

1 ANTA VETRO, 1 RIPIANO VETRO  
1 GLASS DOOR, 1 GLASS SHELF

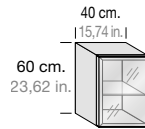

DX / RH  
SX / LH

**DOC2261K**  
**DOC2361K**

VETRO TRASPARENTE  
TRANSPARENT GLASS

**DOC2251K**  
**DOC2351K**

**OPTIONAL**

VETRO GLASS

TOP SOL

FUMÉ  
SMOKED

CANALETTO

**752**

**896**

**+ 37**

**+ 19**

Doghe Multicolor - Multicolor slats

**+ 5 %**

**+ 5 %**

mc 0,10 - Kg 15

mc 0,10 - Kg 15

**PENSILI H. 70 CM.**  
WALL UNITS H. 27,55 IN.

1 ANTA LEGNO, 1 RIPIANO VETRO  
1 WOODEN DOOR, 1 GLASS SHELF

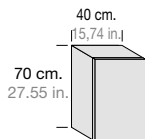

1 ANTA VETRO, 1 RIPIANO VETRO  
1 GLASS DOOR, 1 GLASS SHELF

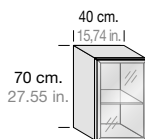

1 ANTA LEGNO, 1 RIPIANO VETRO  
1 WOODEN DOOR, 1 GLASS SHELF

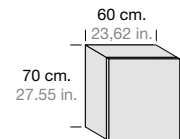

DX / RH  
SX / LH

**DOC2461K**  
**DOC2561K**

VETRO TRASPARENTE  
TRANSPARENT GLASS

**DOC2451K**  
**DOC2551K**

**OPTIONAL**

VETRO GLASS

TOP SOL

FUMÉ  
SMOKED

CANALETTO

**794**

**938**

**+ 43**

**+ 19**

Doghe Multicolor - Multicolor slats

**+ 5 %**

**+ 5 %**

mc 0,12 - Kg 17

mc 0,12 - Kg 17

**871**

**+ 5 %**

mc 0,19 - Kg 22

**PENSILI H. 105 CM.**  
WALL UNITS H. 41,33 IN.

1 ANTA LEGNO, 2 RIPIANI VETRO  
1 WOODEN DOOR, 2 GLASS DOORS

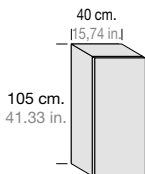

1 ANTA VETRO, 2 RIPIANI VETRO  
1 GLASS DOOR, 1 GLASS SHELF

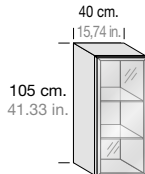

2 ANTE LEGNO, 4 RIPIANI VETRO  
2 DOORS, 4 GLASS SHELVES

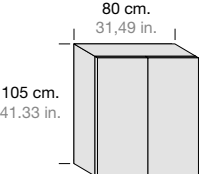

DX / RH  
SX / LH

**DOC2281K**  
**DOC2381K**

VETRO TRASPARENTE  
TRANSPARENT GLASS

**DOC2271K**  
**DOC2371K**

**OPTIONAL**

VETRO GLASS

TOP SOL

FUMÉ  
SMOKED

CANALETTO

**1.047**

**1.125**

**+ 67**

**+ 24**

Doghe Multicolor - Multicolor slats

**+ 5 %**

**+ 5 %**

mc 0,18 - Kg 23

mc 0,18 - Kg 23

**1.852**

**+ 5 %**

mc 0,35 - Kg 32

2 ANTE VETRO, 4 RIPIANI VETRO  
2 GLASS DOORS, 4 GLASS SHELVES

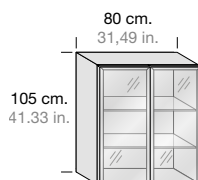

VETRO TRASPARENTE  
TRANSPARENT GLASS

**DOC2621K**

**OPTIONAL**

VETRO GLASS

TOP SOL

FUMÉ  
SMOKED

CANALETTO

**2.116**

**+ 133**

**+ 49**

Doghe Multicolor - Multicolor slats

**+ 5 %**

mc 0,18 - Kg 23

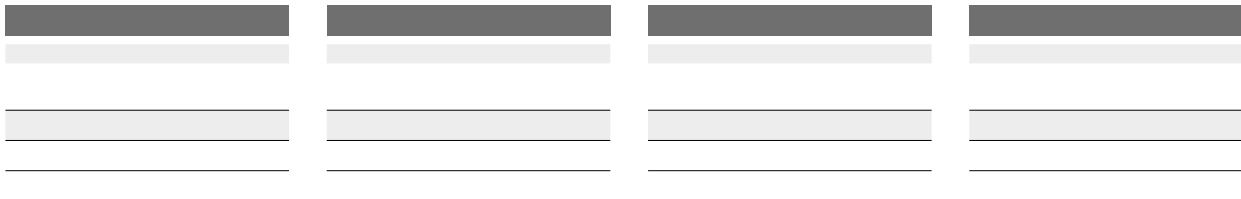

1 ANTA DOGATA, 1 RIPIANO VETRO  
1 SLATTED DOOR, 1 GLASS SHELF

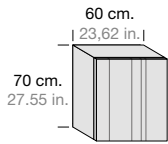

DOGA LEGNO LISCIA  
PLAIN WOODEN SLAT

DOC2406K DOC2506K	OPTIONAL	
	DOGA SLAT	
	DOGA RIGHE STRIPED SLAT	DOGA QUADRO LEGNO WOODEN SQUARE SLAT
<b>1.293</b>		
<b>+ 5 %</b>	<b>+ 79</b>	<b>+ 110</b>
mc 0,19 – Kg 22		

1 ANTA VETRO, 1 RIPIANO VETRO  
1 GLASS DOOR, 1 GLASS SHELF

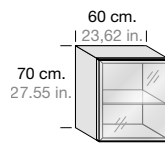

VETRO TRASPARENTE  
TRANSPARENT GLASS

DOC2291K DOC2391K	OPTIONAL	
	VETRO GLASS	
	TOP SOL	FUMÉ SMOKED
<b>1.047</b>		
<b>+ 5 %</b>	<b>+ 67</b>	<b>+ 24</b>
mc 0,19 – Kg 22		

1 ANTA LEGNO, 1 ANTA VETRO, 4 RIPIANI VETRO  
1 DOOR, 1 GLASS DOOR, 4 GLASS SHELVES

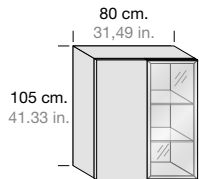

VETRO TRASPARENTE  
TRANSPARENT GLASS

DOC2991K	OPTIONAL	
	VETRO GLASS	
	TOP SOL	FUMÉ SMOKED
<b>1.973</b>		
<b>+ 5 %</b>	<b>+ 67</b>	<b>+ 24</b>
mc 0,35 – Kg 32		

1 ANTA LEGNO, 1 ANTA VETRO, 4 RIPIANI VETRO  
1 DOOR, 1 GLASS DOOR, 4 GLASS SHELVES

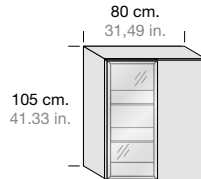

VETRO TRASPARENTE  
TRANSPARENT GLASS

DOC2491K	OPTIONAL	
	VETRO GLASS	
	TOP SOL	FUMÉ SMOKED
<b>1.973</b>		
<b>+ 5 %</b>	<b>+ 67</b>	<b>+ 24</b>
mc 0,35 – Kg 32		

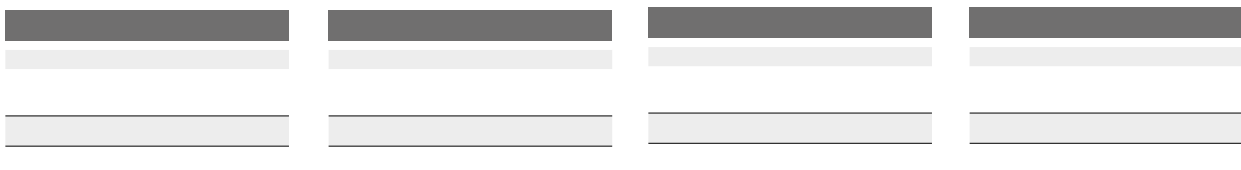

OPTIONAL  
OPTIONAL

BARRA LED A BASSO CONSUMO  
ACCENSIONE TOUCH IN ALLUMINIO  
DA POSIZIONARE SUL COPERCHIO  
DEL PENSILE

LOW CONSUMPTION ALUMINIUM LED  
BAR WITH TOUCH SWITCH ON  
TO ARRANGE ON WALL UNIT TOP

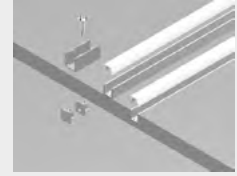

ZZZFE22020

L. 40 cm. w. 15,74 in.

163

ZZZFE22024

L. 60 cm. w. 23,62 in.

175

ZZZFE22025

L. 80 cm. w. 31,49 in.

187

ZZZFE22026

L. 120 cm. w. 47,24 in.

235

ZZZFE22027

L. 140 cm. w. 55,11 in.

253

ALIMENTATORE  
POWER SUPPLY



ZZZFE22002

67

COLLEGAMENTO  
A CARICO DEL CLIENTE  
CONNECTIONS  
TO BE MADE BY THE CUSTOMER.

# DOMINO SISTEMA COMPONIBILE - MODULAR SYSTEM

## PENSILI VERTICALI P. 38 CM., PENSILI A GIORNO E DIVISORI AD "U"

### VERTICAL WALL UNITS D. 14,96 IN., OPEN WALL UNITS AND U-SHAPED PARTITIONS

#### PENSILI H. 120 CM. WALL UNITS H. 47,24 IN.

2 ANTE LEGNO, 2 RIPIANI VETRO  
2 DOORS, 2 GLASS SHELVES

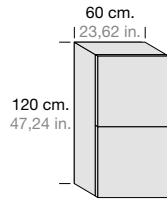

**DOC2671K**  
**DOC2681K**

**1.479**

**+ 5 %**

mc 0,30 – Kg 34

2 ANTE VETRO, 2 RIPIANI VETRO  
2 GLASS DOORS, 2 GLASS SHELVES

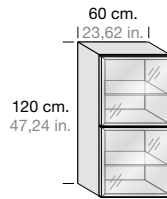

**DOC2241K**  
**DOC2341K**

**1.773**

**+ 5 %**

mc 0,30 – Kg 34

VETRO TRASPARENTE  
TRANSPARENT GLASS

**OPTIONAL**

VETRO GLASS

TOP SOL

**+ 102**

FUMÉ  
SMOKED

**+ 49**

CANALETTO

Doghe Multicolor - Multicolor slats

#### PENSILI H. 140 CM. WALL UNITS H. 55,11 IN.

1 ANTA LEGNO, 3 RIPIANI VETRO  
1 WOODEN DOOR, 3 GLASS SHELVES

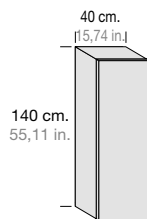

DX / RH  
SX / LH

**DOC2421K**  
**DOC2521K**

**1.191**

**+ 5 %**

mc 0,24 – Kg 28

1 ANTA VETRO, 3 RIPIANI VETRO  
1 GLASS DOOR, 3 GLASS SHELVES

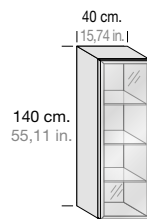

VETRO TRASPARENTE  
TRANSPARENT GLASS

**DOC2411K**  
**DOC2511K**

**1.275**

**+ 5 %**

mc 0,24 – Kg 28

2 ANTE LEGNO, 6 RIPIANI VETRO  
2 WOODEN DOORS, 6 GLASS SHELVES

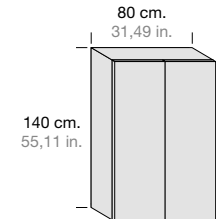

**DOC2811K**

**2.020**

**+ 5 %**

mc 0,47 – Kg 40

CANALETTO

Doghe Multicolor - Multicolor slats

2 ANTE VETRO, 6 RIPIANI VETRO  
2 GLASS DOORS, 6 GLASS SHELVES

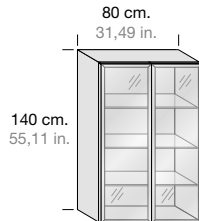

VETRO TRASPARENTE  
TRANSPARENT GLASS

**DOC2861K**

**OPTIONAL**

VETRO GLASS

TOP SOL

**+ 168**

FUMÉ  
SMOKED

**+ 72**

CANALETTO

Doghe Multicolor - Multicolor slats

#### PENSILI A GIORNO P. 38 CM. OPEN WALL UNITS P. 14,96 IN.

A GIORNO  
OPEN

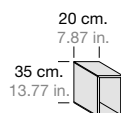

**DOC2701K**

**301**

mc 0,03 – Kg 5

A GIORNO  
OPEN

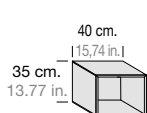

**DOC2711K**

**427**

mc 0,06 – Kg 7

A GIORNO  
OPEN

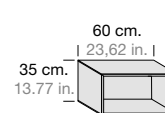

**DOC2721K**

**487**

mc 0,12 – Kg 11

A GIORNO, 1 RIPIANO FISSO LEGNO  
OPEN, 1 WOODEN FIXED SHELF

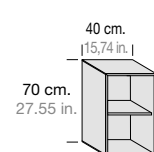

**DOC2731K**

**567**

mc 0,18 – Kg 15

CANALETTO

**2 ANTE DOGATE, 2 RIPIANI VETRO**  
2 SLATTED DOORS, 2 GLASS SHELVES

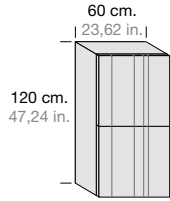

DOGA LEGNO LISCIA  
PLAIN WOODEN SLAT

<b>DOC2676K</b>	<b>OPTIONAL</b>			
<b>DOC2686K</b>	DOGA SLAT			
	DOGA RIGHE STRIPED SLAT	DOGA QUADRO LEGNO WOODEN SQUARE SLAT		
<b>2.146</b>	<b>+ 158</b>	<b>+ 217</b>		
<b>+ 5 %</b>				
mc 0,30 – Kg 34				

**1 ANTA LEGNO, 1 ANTA VETRO, 6 RIPIANI VETRO**  
1 DOOR, 1 GLASS DOOR, 6 GLASS SHELVES

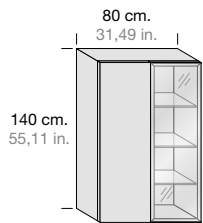

VETRO TRASPARENTE  
TRANSPARENT GLASS

<b>DOC2821K</b>	<b>OPTIONAL</b>			
	VETRO GLASS			
	TOP SOL	FUMÉ SMOKED		
<b>2.140</b>	<b>+ 85</b>	<b>+ 37</b>		
<b>+ 5 %</b>				
mc 0,47 – Kg 40				

**1 ANTA LEGNO, 1 ANTA VETRO, 6 RIPIANI VETRO**  
1 DOOR, 1 GLASS DOOR, 6 GLASS SHELVES

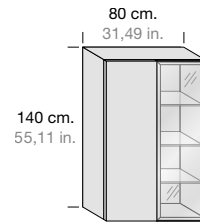

VETRO TRASPARENTE  
TRANSPARENT GLASS

<b>DOC2851K</b>	<b>OPTIONAL</b>			
	VETRO GLASS			
	TOP SOL	FUMÉ SMOKED		
<b>2.140</b>	<b>+ 85</b>	<b>+ 37</b>		
<b>+ 5 %</b>				
mc 0,47 – Kg 40				

**OPTIONAL**  
**OPTIONAL**

BARRA LED A BASSO CONSUMO  
ACCENSIONE TOUCH IN ALLUMINIO  
DA POSIZIONARE SUL COPERCHIO  
DEL PENSILE

LOW CONSUMPTION ALUMINIUM LED  
BAR WITH TOUCH SWITCH ON  
TO ARRANGE ON WALL UNIT TOP

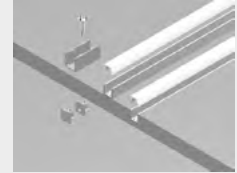

**ZZZFE22020**

L. 40 cm. W. 15,74 in.

**163**

**ZZZFE22024**

L. 60 cm. W. 23,62 in.

**175**

**ZZZFE22025**

L. 80 cm. W. 31,49 in.

**187**

**ZZZFE22026**

L. 120 cm. W. 47,24 in.

**235**

**ZZZFE22027**

L. 140 cm. W. 55,11 in.

**253**

ALIMENTATORE  
POWER SUPPLY



**ZZZFE22002**

**67**

COLLEGAMENTO  
A CARICO DEL CLIENTE  
CONNECTIONS  
TO BE MADE BY THE CUSTOMER.

**A GIORNO, 2 RIPIANI FISSI LEGNO**  
OPEN, 2 WOODEN FIXED SHELVES

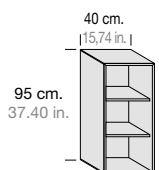

<b>DOC2742K</b>			
<b>650</b>			
mc 0,18 – Kg 15			

**A GIORNO, 2 RIPIANI FISSI LEGNO**  
OPEN, 2 WOODEN FIXED SHELVES

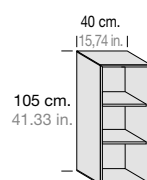

<b>DOC2741K</b>			
<b>662</b>			
mc 0,19 – Kg 19			

# DOMINO SISTEMA COMPONIBILE - MODULAR SYSTEM

## COLONNE A GIORNO P. 30 CM. RAISED TALL UNITS P. 11,81 IN.

**DIVISORI AD "U" P. 30 CM.  
(MENSOLA OBBLIGATORIA)**  
U-SHAPED PARTITIONS  
D. 11,81 IN.  
(COMPULSORY SHELF)

SENZA CAPPELLO, CON CORNICE  
WITHOUT TOP, WITH FRAME

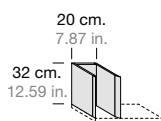

SENZA CAPPELLO, CON CORNICE  
WITHOUT TOP, WITH FRAME

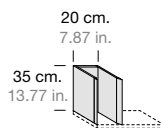

**DOC3981K**

**DOC3991K**

CANALETTO

**211**

mc 0,02 – Kg 0,5

**217**

mc 0,02 – Kg 0,5

**COLONNE A GIORNO P. 30 CM.  
DA APPOGGIO SOTTOPENSILI**  
RAISED TALL UNITS  
D. 11,81 IN.  
UNDER WALL UNITS

2 RIPIANI LEGNO  
2 WOODEN SHELVES

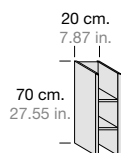

2 RIPIANI LEGNO  
2 WOODEN SHELVES

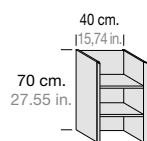

3 RIPIANI LEGNO  
3 WOODEN SHELVES

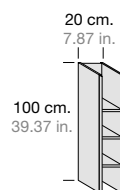

3 RIPIANI LEGNO  
3 WOODEN SHELVES

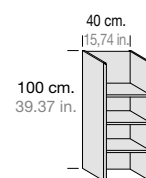

**DOC2801K**

**DOC2881K**

**DOC2651K**

**DOC2841K**

CANALETTO

**535**

mc 0,05 – Kg 6

**607**

mc 0,09 – Kg 7

**674**

mc 0,08 – Kg 9

**800**

mc 0,15 – Kg 11

**COLONNE A GIORNO P. 30 CM.  
DA APPOGGIO**  
RAISED OPEN TALL UNITS  
D. 11,81 IN.

2 RIPIANI LEGNO  
2 WOODEN SHELVES

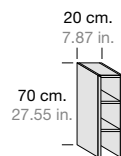

2 RIPIANI LEGNO  
2 WOODEN SHELVES

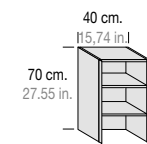

3 RIPIANI LEGNO  
3 WOODEN SHELVES

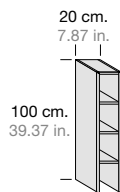

3 RIPIANI LEGNO  
3 WOODEN SHELVES

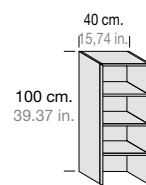

**DOC2911K**

**DOC2921K**

**DOC2661K**

**DOC2931K**

CANALETTO

**595**

mc 0,05 – Kg 7

**698**

mc 0,09 – Kg 8

**727**

mc 0,08 – Kg 10

**884**

mc 0,15 – Kg 12

**MENSOLE DI GIUNZIONE  
P. 30 CM. PER COLONNE A  
GIORNO IN APPOGGIO**  
JOINT SHELVES  
D. 11,81 IN. FOR RAISED  
OPEN TALL UNITS



**DOC2801C**

**DOC2811C**

**DOC2821C**

CANALETTO

**67**

mc 0,01 – Kg 0,5

**91**

mc 0,01 – Kg 1

**115**

mc 0,01 – Kg 1,5

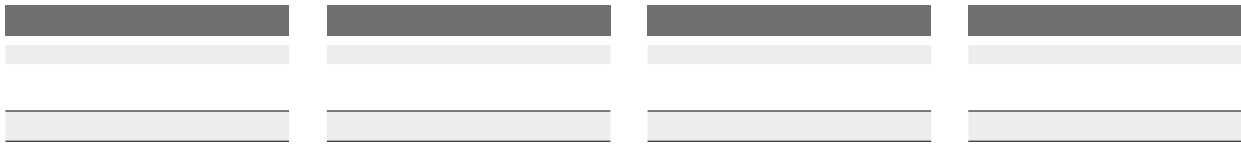

**2 RIPIANI LEGNO**  
2 WOODEN SHELVES

**2 RIPIANI LEGNO**  
2 WOODEN SHELVES

**3 RIPIANI LEGNO**  
3 WOODEN SHELVES

**3 RIPIANI LEGNO**  
3 WOODEN SHELVES

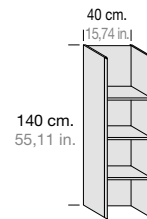
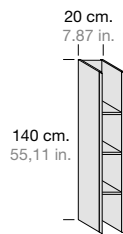
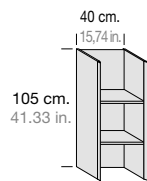
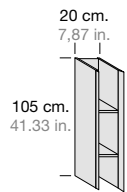

**DOC2631K**

**DOC2871K**

**DOC2891K**

**DOC2901K**

**638**

mc 0,07 – Kg 9

**813**

mc 0,14 – Kg 11

**770**

mc 0,09 – Kg 13

**890**

mc 0,18 – Kg 16

**2 RIPIANI LEGNO**  
2 WOODEN SHELVES

**2 RIPIANI LEGNO**  
2 WOODEN SHELVES

**3 RIPIANI LEGNO**  
3 WOODEN SHELVES

**3 RIPIANI LEGNO**  
3 WOODEN SHELVES

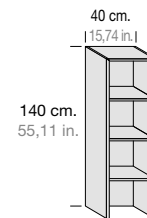
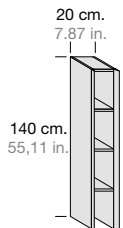
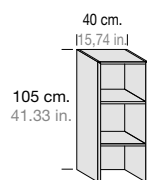
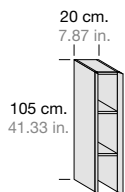

**DOC2641K**

**DOC2941K**

**DOC2951K**

**DOC2961K**

**698**

mc 0,07 – Kg 9

**896**

mc 0,14 – Kg 11

**831**

mc 0,09 – Kg 14

**975**

mc 0,18 – Kg 17

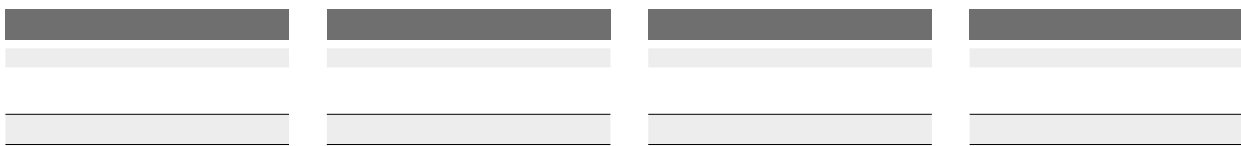

# DOMINO SISTEMA COMPONIBILE - MODULAR SYSTEM

## COMPOSIZIONI A CATALOGO

## CATALOGUE COMPOSITIONS

### COMPOSIZIONE 17

### COMPOSITION 17

PAG. 74-75 CATALOGO "DESIGN"  
PAGE 74-75 "DESIGN" CATALOGUE

1	<b>DOC2381K</b>	PENSILE VERTICALE ANTA LEGNO SX L 40 H 105 VERTICAL WALL UNIT WITH WOODEN DOOR LH W 40 H 105	<b>1.047</b>
1	<b>DOC2741K</b>	PENSILE A GIORNO L 40 H 105 OPEN WALL UNIT W 40 H 105	<b>662</b>
1	<b>DOG5006K</b>	PORTA TV L 181 H 55 P 43 DOGA LEGNO QUADRO TV UNIT W 181 H 55 D 43 SQUARE WOODEN SLAT	<b>3.386</b>
<b>PREZZO TOT. COMPOSIZIONE</b> TOTAL PRICE FOR COMPOSITION			<b>5.095</b>

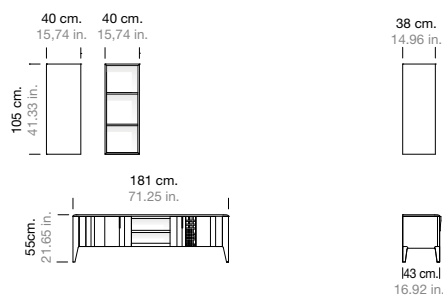

L. 181 cm.  
W. 71,25 in.  
P. 38/43 cm.  
D. 14,96 in.  
16,92 in.

### COMPOSIZIONE 40

### COMPOSITION 40

PAG. 110-111 CATALOGO "DESIGN"  
PAGE 110-111 "DESIGN" CATALOGUE

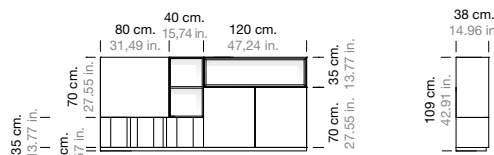

1	<b>DOC2541K</b>	PENSILE ANTA LEGNO SX L 80 H 70 WALL UNIT WITH WOODEN DOOR LH W 80 H 70	<b>981</b>
1	<b>DOC2611K</b>	PENSILE 2 ANTE LEGNO L 120 H 70 WALL UNIT WITH 2 WOODEN DOORS W 120 H 70	<b>1.569</b>
1	<b>DOC2731K</b>	PENSILE A GIORNO L 40 H 70 OPEN WALL UNIT W 40 H 70	<b>567</b>
1	<b>DOC2781K</b>	PENSILE A GIORNO CON CORNICE L 120 H 35 OPEN WALL UNIT WITH FRAME W 120 H 35	<b>836</b>
1	<b>DOC1376K</b>	BASE CESTONE L 120 P 38 DOGA LEGNO LISCIA BASE UNIT WITH BASKET W 120 D 38 PLAIN WOODEN SLAT	<b>1.341</b>
1	<b>DOC3321K</b>	ZOCCOLO L 240 P 35 PLINTH W 240 D 35	<b>349</b>
<b>PREZZO TOT. COMPOSIZIONE</b> TOTAL PRICE FOR COMPOSITION			<b>5.643</b>



L. 240 cm.  
W. 94,48 in.  
P. 38 cm.  
D. 14,96 in.

### COMPOSIZIONE 86

### COMPOSITION 86

PAG. 122-123 CATALOGO "DESIGN"  
PAGE 122-123 "DESIGN" CATALOGUE

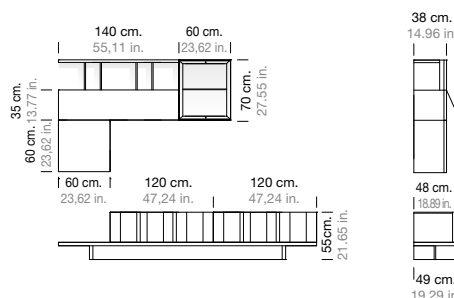
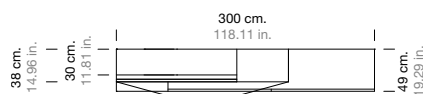

1	<b>DOC3051K</b>	PEDANA L 300 P 49 PLATFORM W 300 D 49	<b>999</b>
2	<b>DOC1066K</b>	BASE CESTONE L 120 P 48 DOGA LEGNO LISCIA BASE UNIT WITH BASKET W 120 D 48 PLAIN WOODEN SLAT	<b>2.706</b>
1	<b>DOC5101K</b>	TOP L 240 P 45 TOP W 240 D 45	<b>349</b>
1	<b>DOC3551K</b>	MENSOLA L 140 P 30 SHELF W 140 D 30	<b>247</b>
2	<b>DOC3981K</b>	DIVISORIO AD U L 20 H 32 U-SHAPED PARTITION W 20 H 35	<b>422</b>
1	<b>DOC2291K</b>	PENSILE ANTA VETRO TOP SOL DX L 60 H 70 WALL UNIT WITH TOP SOL GLASS DOOR RH W 60 H 70	<b>1.114</b>
1	<b>DOC2191K</b>	PENSILE VASISTAS ANTA LEGNO 140 WALL UNIT WITH WOODEN LIFT-UP DOOR W 140	<b>1.119</b>
1	<b>DOC2311K</b>	PENSILE ANTA LEGNO SX L 60 H 60 WALL UNIT WITH WOODEN DOOR RH W 60 H 60	<b>848</b>
<b>TOTALE COMPOSIZIONE</b> TOTAL PRICE FOR COMPOSITION			<b>7.804</b>

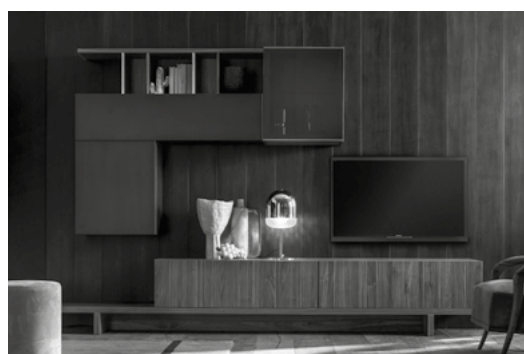

L. 300 cm.  
W. 118,11 in.  
P. 49 cm.  
D. 19,29 in.



## COMPOSIZIONI A CATALOGO CATALOGUE COMPOSITIONS

### COMPOSIZIONE 87/B

#### COMPOSITION 87/B

PAG. 124-125 CATALOGO "DESIGN"  
PAGE 124-125 "DESIGN" CATALOGUE

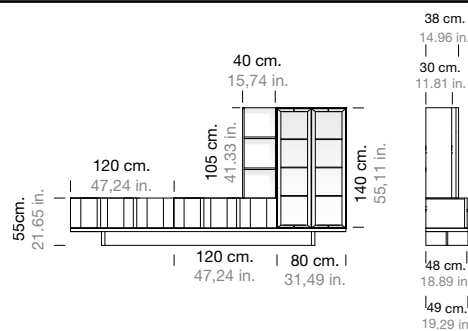
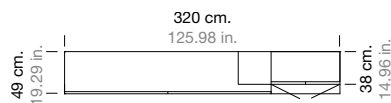

1	<b>DOC3061K</b>	PEDANA L 320 P 49 PLATFORM W 320 D 49	<b>1.023</b>
2	<b>DOC1066K</b>	BASE CESTONE L 120 P 48 DOGA LEGNO LISCIA BASE UNIT WITH BASKET W 120 D 48 PLAIN WOODEN SLAT	<b>2.706</b>
1	<b>DOC5101K</b>	TOP L 240 P 45 TOP W 240 D 45	<b>349</b>
1	<b>DOC2861K</b>	PENSILE 2 ANTE VETRO FUMÉ L 80 H 140 WALL UNIT WITH 2 SMOKED GLASS DOORS W 80 H 140	<b>2.386</b>
1	<b>DOC2941K</b>	COLONNA A GIORNO SOTTOPENSILE 2 RIPIANI L 40 H 105 OPEN TALL UNIT UNDER WALL UNIT WITH 2 SHELVES W 40 H 105	<b>896</b>
<b>TOTALE COMPOSIZIONE</b> TOTAL PRICE FOR COMPOSITION			<b>7.360</b>



L. 320 cm.  
W. 125,98 in.  
P. 49 cm.  
D. 19,29 in.

### COMPOSIZIONE 90/A

#### COMPOSITION 907A

PAG. 128-129 CATALOGO "DESIGN"  
PAGE 128-129 "DESIGN" CATALOGUE

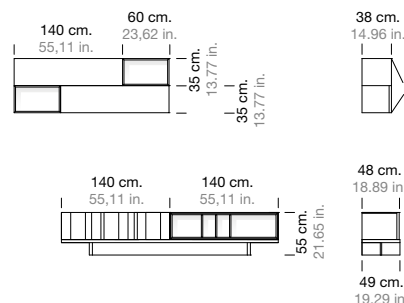
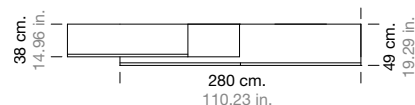

1	<b>DOC3041K</b>	PEDANA L 280 P 49 PLATFORM W 280 D 49	<b>938</b>
1	<b>DOC1086K</b>	BASE CESTONE L 140 P 48 DOGA LEGNO LISCIA BASE UNIT WITH BASKET W 140 D 48 PLAIN WOODEN SLAT	<b>1.432</b>
1	<b>DOC1621K</b>	BASE A GIORNO CON 3 DIVISORI INTERNI L 140 P 48 OPEN BASE UNIT WITH 3 INTERNAL PARTITIONS W 140 P 48	<b>1.155</b>
1	<b>DOC5121K</b>	TOP L 280 P 45 TOP W 280 D 45	<b>397</b>
2	<b>DOC2721K</b>	PENSILE A GIORNO L 60 H 35 OPEN WALL UNIT W 60 H 35	<b>974</b>
1	<b>DOC2191K</b>	PENSILE VASISTAS ANTA LEGNO L 140 WALL UNIT WITH WOODEN LIFT-UP DOOR W 140	<b>1.119</b>
1	<b>DOC2171K</b>	PENSILE RIBALTA ANTA LEGNO L 140 WALL UNIT WITH WOODEN DROP-DOWN DOOR W 140	<b>1.197</b>
<b>TOTALE COMPOSIZIONE</b> TOTAL PRICE FOR COMPOSITION			<b>7.212</b>



L. 340 cm.  
W. 133,85 in.  
P. 49 cm.  
D. 19,29 in.

### COMPOSIZIONE 84

#### COMPOSITION 84

PAG. 130-131 CATALOGO "DESIGN"  
PAGE 130-131 "DESIGN" CATALOGUE

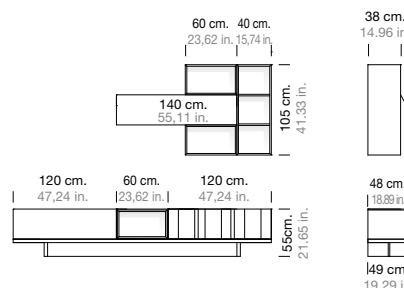
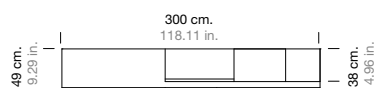

1	<b>DOC3051K</b>	PEDANA L 300 P 49 PLATFORM W 300 D 49	<b>999</b>
1	<b>DOC1221K</b>	BASE A GIORNO L 60 P 48 OPEN BASE UNIT W 60 D 48	<b>650</b>
1	<b>DOC1066K</b>	BASE CESTONE L 120 P 48 DOGA LEGNO LISCIA BASE UNIT WITH BASKET W 120 D 48 PLAIN WOODEN SLAT	<b>1.353</b>
1	<b>DOC1061K</b>	BASE CESTONE L 120 P 48 BASE UNIT WITH BASKET W 120 D 48 PLAIN	<b>1.059</b>
1	<b>DOC5131K</b>	TOP L 300 P 45 TOP W 300 D 45	<b>422</b>
1	<b>DOC2741K</b>	PENSILE A GIORNO L 40 H 105 OPEN WALL UNIT W 40 H 105	<b>662</b>
2	<b>DOC2721K</b>	PENSILE A GIORNO L 60 H 35 OPEN WALL UNIT W 60 H 35	<b>974</b>
1	<b>DOC2191K</b>	PENSILE VASISTAS ANTA LEGNO L 140 WALL UNIT WITH WOODEN LIFT-UP DOOR W 140	<b>1.119</b>
<b>TOTALE COMPOSIZIONE</b> TOTAL PRICE FOR COMPOSITION			<b>7.238</b>



L. 300 cm.  
W. 118,11 in.  
P. 49 cm.  
D. 19,29 in.

# DOMINO SISTEMA COMPONIBILE - MODULAR SYSTEM

## COMPOSIZIONI A CATALOGO

### CATALOGUE COMPOSITIONS

#### COMPOSIZIONE 50

#### COMPOSITION 50

PAG. 132-133 CATALOGO "DESIGN"  
PAGE 132-133 "DESIGN" CATALOGUE

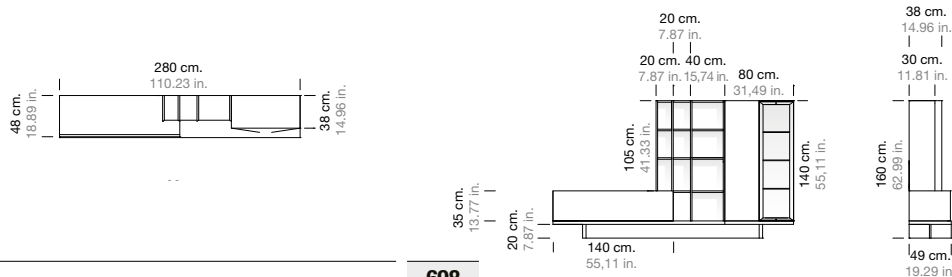

1	<b>DOC2641K</b>	COLONNA A GIORNO 2 RIPIANI L 20 H 105 OPEN TALL UNIT WITH 2 SHELVES W 20 H 105	<b>698</b>
4	<b>DOC2801C</b>	MENSOLE DI GIUNZIONE L 20 JOINT SHELVES W 20	<b>268</b>
1	<b>DOC2961K</b>	COLONNA A GIORNO 3 RIPIANI L 40 H 140 OPEN TALL UNIT WITH 3 SHELVES W 40 H 140	<b>975</b>
1	<b>DOC2821K</b>	PENSILE VERTICALE ANTA LEGNO SX ANTA VETRO TRASPARENTE DX L 80 H 140 VERTICAL WALL UNIT WITH PLAIN WOODEN DOOR LH TRANSPARENT GLASS DOOR RH W 80 H 140	<b>2.140</b>
1	<b>DOC1081K</b>	BASE CESTONE L 140 P 48 BASE UNIT WITH BASKET W 140 D 48 PLAIN	<b>1.167</b>
1	<b>DOC5051K</b>	TOP L 140 P 45 TOP W 140 D 45	<b>206</b>
1	<b>DOC3041K</b>	PEDANA L 280 P 49 PLATFORM W 280 D 49	<b>938</b>
<b>PREZZO TOT. COMPOSIZIONE</b> TOTAL PRICE FOR COMPOSITION			<b>6.392</b>



L. 280 cm.  
W. 110,23 in.  
  
P. 38/43 cm.  
D. 14,96 in.  
16,92 in.

#### COMPOSIZIONE 06

#### COMPOSITION 06

PAG. 134-135 CATALOGO "DESIGN"  
PAGE 134-135 "DESIGN" CATALOGUE

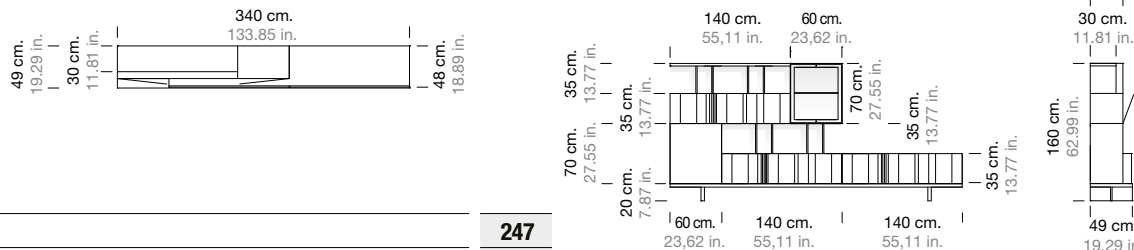

1	<b>DOC3551K</b>	MENSOLA L 140 SHELF W 140	<b>247</b>
2	<b>DOC3981K</b>	DIVISORIO AD U L 20 H 32 U-SHAPED PARTITION W 20 H 32	<b>422</b>
1	<b>DOC2291K</b>	PENSILE VERTICALE ANTA VETRO TOP SOL DX L 60 H 70 VERTICAL WALL UNIT WITH TOP SOL GLASS DOOR RH W 60 H 70	<b>1.112</b>
1	<b>DOC2176K</b>	PENSILE RIBALTA L 140 P 38 DOGA RIGHE WALL UNIT DROP-DOWN DOOR W 140 D 38 RIBBED SLAT	<b>1.630</b>
2	<b>DOC3991K</b>	DIVISORIO AD U L 20 H 35 U-SHAPED PARTITION W 20 H 35	<b>434</b>
1	<b>DOC2501K</b>	PENSILE VERTICALE ANTA LEGNO SX L 60 H 70 VERTICAL WALL UNIT WITH WOODEN DOOR LH W 60 H 70	<b>871</b>
2	<b>DOC1086K</b>	BASE CESTONE L 140 P 48 DOGA RIGHE BASE UNIT WITH BASKET W 140 D 48 RIBBED SLAT	<b>2.998</b>
1	<b>DOC5121K</b>	TOP L 280 P 45 TOP W 280 D 45	<b>397</b>
1	<b>DOC3071K</b>	PEDANA L 340 P 49 PLATFORM W 340 D 49	<b>1.047</b>
<b>PREZZO TOT. COMPOSIZIONE</b> TOTAL PRICE FOR COMPOSITION			<b>9.158</b>



L. 340 cm.  
W. 133,85 in.  
  
P. 38/49 cm.  
D. 14,96 in.  
19,29 in.

#### COMPOSIZIONE 160

#### COMPOSITION 160

PAG. 138-139 CATALOGO "DESIGN"  
PAGE 138-139 "DESIGN" CATALOGUE

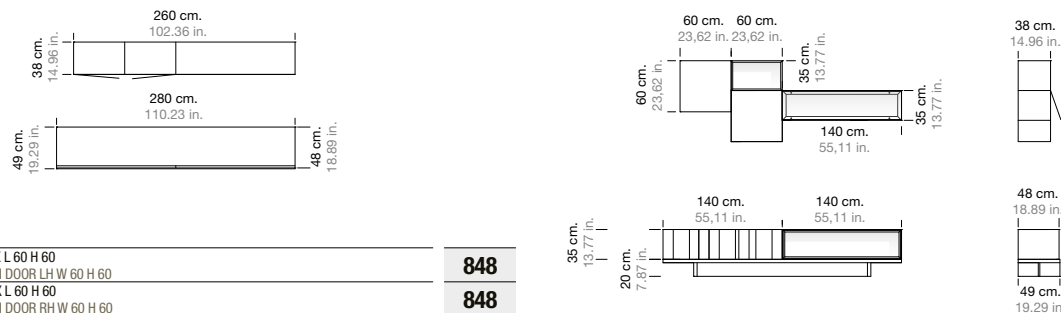

1	<b>DOC2311K</b>	PENSILE VERTICALE ANTA LEGNO SX L 60 H 60 VERTICAL WALL UNIT WITH WOODEN DOOR LH W 60 H 60	<b>848</b>
1	<b>DOC2211K</b>	PENSILE VERTICALE ANTA LEGNO DX L 60 H 60 VERTICAL WALL UNIT WITH WOODEN DOOR RH W 60 H 60	<b>848</b>
1	<b>DOC2721K</b>	PENSILE A GIORNO L 60 H 35 OPEN WALL UNIT W 60 H 35	<b>487</b>
1	<b>DOC2181K</b>	PENSILE VASISTAS ANTA VETRO TOP SOL L 140 P 38 WALL UNIT WITH TOP SOL GLASS LIFT-UP DOOR W 140 D 38	<b>1.408</b>
1	<b>DOC1086K</b>	BASE CESTONE L 140 P 48 DOGA LEGNO LISCIA BASE UNIT WITH BASKET W 140 D 48 PLAIN WOODEN SLAT	<b>1.432</b>
1	<b>DOC1251K</b>	BASE A GIORNO L 140 P 48 OPEN BASE UNIT W 140 D 48	<b>938</b>
1	<b>DOC5121K</b>	TOP L 280 P 45 TOP W 280 D 45	<b>397</b>
1	<b>DOC3041K</b>	PEDANA L 280 P 49 PLATFORM W 280 D 49	<b>938</b>
<b>PREZZO TOT. COMPOSIZIONE</b> TOTAL PRICE FOR COMPOSITION			<b>7.296</b>



L. 280 cm.  
W. 110,23 in.  
  
P. 38/49 cm.  
D. 14,96 in.  
19,29 in.

## COMPOSIZIONI A CATALOGO CATALOGUE COMPOSITIONS

### COMPOSIZIONE 04 COMPOSITION 04

PAG. 142-143 CATALOGO "DESIGN"  
PAGE 142-143 "DESIGN" CATALOGUE

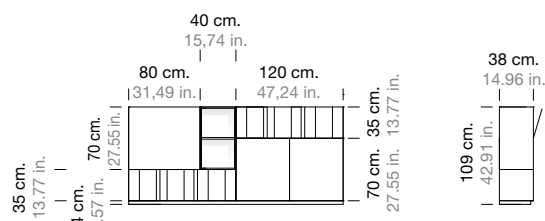
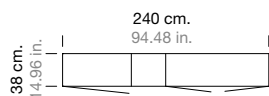

1	<b>DOC2541K</b>	PENSILE ANTA LEGNO SX L 80 H 70 WALL UNIT WITH WOODEN DOOR LH W 80 H 70	<b>981</b>
1	<b>DOC2611K</b>	PENSILE 2 ANTE LEGNO L 120 H 70 WALL UNIT WITH 2 WOODEN DOORS W 120 H 70	<b>1.569</b>
1	<b>DOC2731K</b>	PENSILE A GIORNO L 40 H 70 OPEN WALL UNIT W 40 H 70	<b>567</b>
1	<b>DOC2136K</b>	PENSILE RIBALTA L 120 P 38 DOGA LEGNO LISCIA WALL UNIT DROP-DOWN W 120 D 38 PLAIN WOODEN SLAT	<b>1.419</b>
1	<b>DOC1376K</b>	BASE CESTONE L 120 P 38 DOGA LEGNO LISCIA BASE UNIT WITH BASKET W 120 D 38 PLAIN WOODEN SLAT	<b>1.341</b>
1	<b>DOC3321K</b>	ZOCCOLO L 240 P 35 PLINTH W 240 D 35	<b>349</b>
<b>PREZZO TOT. COMPOSIZIONE</b> TOTAL PRICE FOR COMPOSITION			<b>6.226</b>



L. 240 cm.  
W. 94,48 in.  
  
P. 38 cm.  
D. 14,96 in.

### COMPOSIZIONE 20 COMPOSITION 20

PAG. 8 CATALOGO "PROPOSTE ARREDATIVE"  
PAGE 8 "FURNISHING PROPOSALS" CATALOGUE

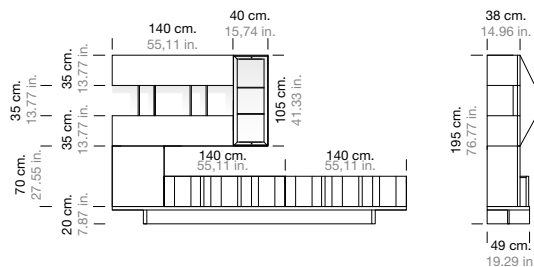
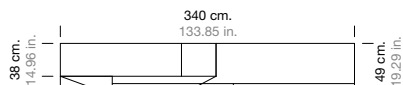

1	<b>DOC3071K</b>	PEDANA L 340 P 49 PLATFORM W 340 D 49	<b>1.047</b>
2	<b>DOC1086K</b>	BASE CESTONE L 140 P 48 DOGA LEGNO LISCIA BASE UNIT WITH BASKET W 140 D 48 PLAIN WOODEN SLAT	<b>2.864</b>
1	<b>DOC5121K</b>	TOP L 280 P 45 TOP W 280 D 45	<b>397</b>
1	<b>DOC2501K</b>	PENSILE VERTICALE ANTA LEGNO SX L 60 H 70 VERTICAL WALL UNIT WITH WOODEN DOOR LH W 60 H 70	<b>871</b>
1	<b>DOC2171K</b>	PENSILE RIBALTA ANTA LEGNO L 140 WALL UNIT WITH WOODEN DROP-DOWN DOOR W 140	<b>1.197</b>
1	<b>DOC2271K</b>	PENSILE VERTICALE ANTA VETRO DX L 40 H 105 VERTICAL WALL UNIT WITH GLASS DOOR RH W 40 H 105	<b>1.125</b>
2	<b>DOC3991K</b>	DIVISORIO AD U L 20 H 35 U-SHAPED PARTITION W 20 H 35	<b>434</b>
1	<b>DOC2191K</b>	PENSILE VASISTAS ANTA LEGNO L 140 WALL UNIT WITH WOODEN LIFT-UP DOOR W 140	<b>1.119</b>
<b>PREZZO TOT. COMPOSIZIONE</b> TOTAL PRICE FOR COMPOSITION			<b>9.054</b>



L. 340 cm.  
W. 133,85 in.  
  
P. 38/49 cm.  
D. 14,96 in.  
19,29 in.

### COMPOSIZIONE 22 COMPOSITION 22

PAG. 9 CATALOGO "PROPOSTE ARREDATIVE"  
PAGE 9 "FURNISHING PROPOSALS" CATALOGUE

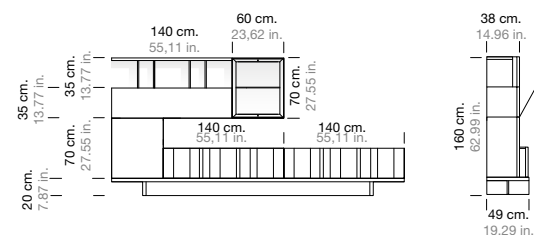
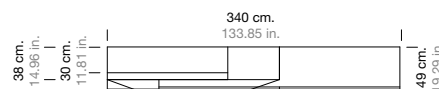

1	<b>DOC3071K</b>	PEDANA L 340 P 49 PLATFORM W 340 D 49	<b>1.047</b>
2	<b>DOC1086K</b>	BASE CESTONE L 140 P 48 DOGA LEGNO LISCIA BASE UNIT WITH BASKET W 140 D 48 PLAIN WOODEN SLAT	<b>2.864</b>
1	<b>DOC5121K</b>	TOP L 280 P 45 TOP W 280 D 45	<b>397</b>
1	<b>DOC2501K</b>	PENSILE VERTICALE ANTA LEGNO SX L 60 H 70 VERTICAL WALL UNIT WITH WOODEN DOOR LH W 60 H 70	<b>871</b>
1	<b>DOC2171K</b>	PENSILE RIBALTA ANTA LEGNO L 140 WALL UNIT WITH WOODEN DROP-DOWN DOOR W 140	<b>1.197</b>
1	<b>DOC2291K</b>	PENSILE VERTICALE ANTA VETRO DX L 60 H 70 VERTICAL WALL UNIT WITH GLASS DOOR RH W 60 H 70	<b>1.047</b>
2	<b>DOC3981K</b>	DIVISORIO AD U L 20 H 32 U-SHAPED PARTITION W 20 H 32	<b>422</b>
1	<b>DOC3551K</b>	MENSOLA L 140 SHELF W 140	<b>247</b>
<b>PREZZO TOT. COMPOSIZIONE</b> TOTAL PRICE FOR COMPOSITION			<b>8.092</b>

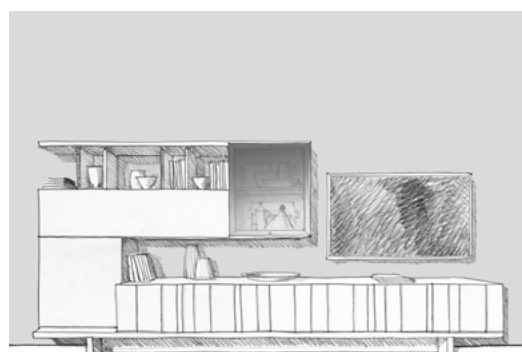

L. 340 cm.  
W. 133,85 in.  
  
P. 38/49 cm.  
D. 14,96 in.  
19,29 in.

# DOMINO SISTEMA COMPONIBILE - MODULAR SYSTEM

## COMPOSIZIONI A CATALOGO

## CATALOGUE COMPOSITIONS

### COMPOSIZIONE 24

#### COMPOSITION 24

PAG. 10 CATALOGO "PROPOSTE ARREDATIVE"  
PAGE 10 "FURNISHING PROPOSALS" CATALOGUE

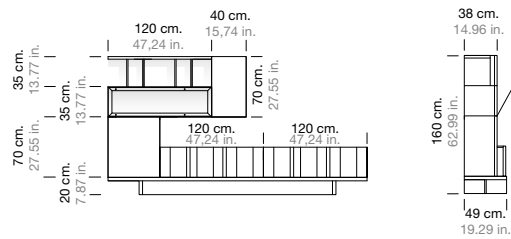
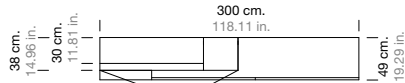

1	<b>DOC3051K</b>	PEDANA L 300 P 49 PLATFORM W 300 D 49	<b>999</b>
2	<b>DOC1066K</b>	BASE CESTONE L 120 P 48 DOGA LEGNO LISCIA BASE UNIT WITH BASKET W 120 D 48 PLAIN WOODEN SLAT	<b>2.706</b>
1	<b>DOC5101K</b>	TOP L 240 P 45 TOP W 240 D 45	<b>349</b>
1	<b>DOC2501K</b>	PENSILE VERTICALE ANTA LEGNO SX L 60 H 70 VERTICAL WALL UNIT WITH WOODEN DOOR LH W 60 H 70	<b>871</b>
1	<b>DOC2121K</b>	PENSILE RIBALTA ANTA VETRO L 120 WALL UNIT WITH GLASS DROP-DOWN DOOR W 120	<b>1.209</b>
1	<b>DOC2461K</b>	PENSILE VERTICALE ANTA LEGNO DX L 40 H 70 VERTICAL WALL UNIT WITH WOODEN DOOR RH W 40 H 70	<b>794</b>
2	<b>DOC3981K</b>	DIVISORIO AD U L 20 H 32 U-SHAPED PARTITION W 20 H 32	<b>422</b>
1	<b>DOC3541K</b>	MENSOLA L 120 SHELF W 120	<b>217</b>

**PREZZO TOT. COMPOSIZIONE**  
**TOTAL PRICE FOR COMPOSITION** **7.567**



L. 300 cm.  
W. 118,11 in.  
  
P. 38/49 cm.  
D. 14,96 in.  
19,29 in.

### COMPOSIZIONE 26

#### COMPOSITION 26

PAG. 11 CATALOGO "PROPOSTE ARREDATIVE"  
PAGE 11 "FURNISHING PROPOSALS" CATALOGUE

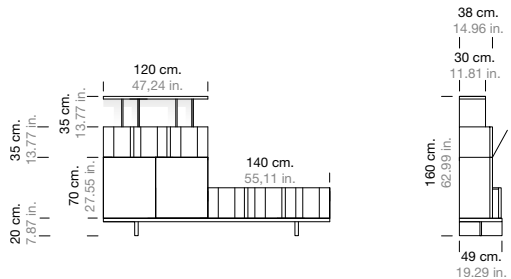
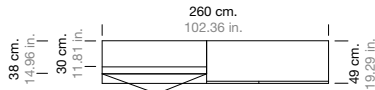

1	<b>DOC3031K</b>	PEDANA L 260 P 49 PLATFORM W 320 D 49	<b>848</b>
1	<b>DOC1086K</b>	BASE CESTONE L 140 P 48 DOGA LEGNO LISCIA BASE UNIT WITH BASKET W 140 D 48 PLAIN WOODEN SLAT	<b>1.432</b>
1	<b>DOC5051K</b>	TOP L 140 P 45 TOP W 140 D 45	<b>206</b>
1	<b>DOC2611K</b>	PENSILE ORIZZONTALE 2 ANTE LEGNO L 120 H 70 HORIZONTAL WALL UNIT WITH 2 WOODEN DOORS W 120 H 70	<b>1.569</b>
1	<b>DOC2136K</b>	PENSILE RIBALTA L 120 DOGA LEGNO LISCIA WALL UNIT DROP-DOWN W 120 PLAIN WOODEN SLAT	<b>1.419</b>
2	<b>DOC3981K</b>	DIVISORIO AD U L 20 H 32 U-SHAPED PARTITION W 20 H 32	<b>422</b>
1	<b>DOC3541K</b>	MENSOLA L 120 SHELF W 120	<b>217</b>

**PREZZO TOT. COMPOSIZIONE**  
**TOTAL PRICE FOR COMPOSITION** **6.113**

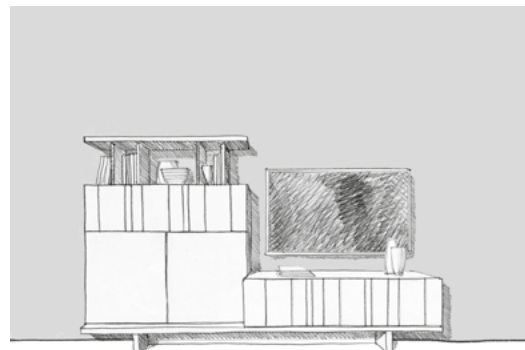

L. 260 cm.  
W. 102,36 in.  
  
P. 38/49 cm.  
D. 14,96 in.  
19,29 in.

### COMPOSIZIONE 28

#### COMPOSITION 28

PAG. 12 CATALOGO "PROPOSTE ARREDATIVE"  
PAGE 12 "FURNISHING PROPOSALS" CATALOGUE

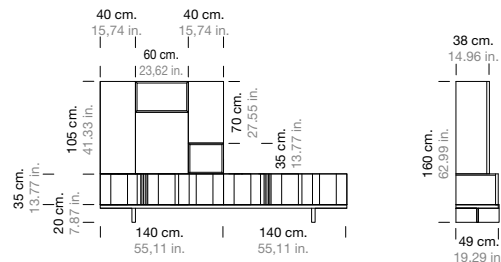
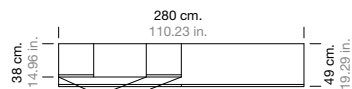

1	<b>DOC3041K</b>	PEDANA L 280 P 49 PLATFORM W 280 D 49	<b>938</b>
2	<b>DOC1086K</b>	BASE CESTONE L 140 P 48 DOGA RIGHE BASE UNIT WITH BASKET W 140 D 48 RIBBED SLAT	<b>2.998</b>
1	<b>DOC5121K</b>	TOP L 280 P 45 TOP W 280 D 45	<b>397</b>
1	<b>DOC2381K</b>	PENSILE VERTICALE ANTA LEGNO SX L 40 H 105 VERTICAL WALL UNIT WITH WOODEN DOOR LH W 40 H 105	<b>1.047</b>
1	<b>DOC2401K</b>	PENSILE VERTICALE ANTA LEGNO DX L 60 H 70 VERTICAL WALL UNIT WITH WOODEN DOOR RH W 60 H 70	<b>871</b>
1	<b>DOC2461K</b>	PENSILE VERTICALE ANTA LEGNO DX L 40 H 70 VERTICAL WALL UNIT WITH WOODEN DOOR RH W 40 H 70	<b>794</b>
1	<b>DOC2721K</b>	PENSILE A GIORNO L 60 H 35 OPEN WALL UNIT W 60 H 35	<b>487</b>
1	<b>DOC2711K</b>	PENSILE A GIORNO L 40 H 35 OPEN WALL UNIT W 40 H 35	<b>427</b>

**PREZZO TOT. COMPOSIZIONE**  
**TOTAL PRICE FOR COMPOSITION** **7.959**

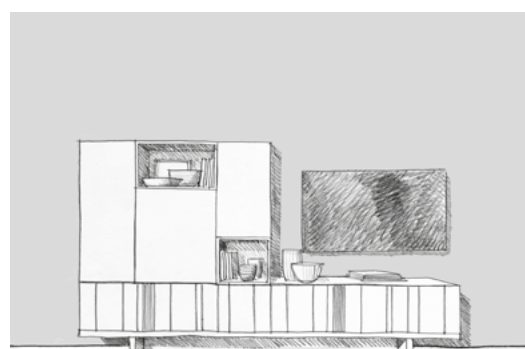

L. 280 cm.  
W. 110,23 in.  
  
P. 38/49 cm.  
D. 14,96 in.  
19,29 in.

## COMPOSIZIONI A CATALOGO CATALOGUE COMPOSITIONS

### COMPOSIZIONE 30 COMPOSITION 30

PAG. 13 CATALOGO "PROPOSTE ARREDATIVE"  
PAGE 13 "FURNISHING PROPOSALS" CATALOGUE



1	<b>DOC3041K</b>	PEDANA L 280 P 49 PLATFORM W 280 D 49	<b>938</b>
2	<b>DOC1086K</b>	BASE CESTONE L 140 P 48 DOGA RICHE BASE UNIT WITH BASKET W 140 D 48 RIBBED SLAT	<b>2.998</b>
1	<b>DOC5121K</b>	TOP L 280 P 45 TOP W 280 D 45	<b>397</b>
1	<b>DOC2881K</b>	COLONNA A GIORNO SOTTO PENSILE CON 2 RIPIANI LEGNO L 40 H 70 OPEN TALL UNIT UNDER WALL UNIT WITH 2 WOODEN SHELVES W 40 H 70	<b>607</b>
1	<b>DOC2176K</b>	PENSILE RIBALTA L 140 DOGA RICHE WALL UNIT DROP-DOWN W 140 RIBBED SLAT	<b>1.631</b>
1	<b>DOC2181K</b>	PENSILE VASISTAS ANTA VETRO L 140 WALL UNIT WITH GLASS LIFT-UP DOOR W 140	<b>1.323</b>
<b>PREZZO TOT. COMPOSIZIONE</b> TOTAL PRICE FOR COMPOSITION			<b>7.894</b>

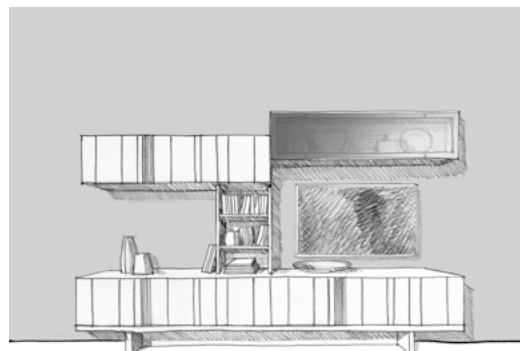
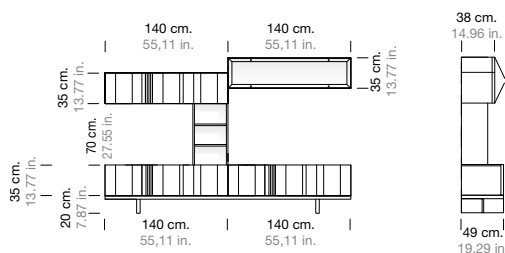

L. 280 cm.  
W. 110,23 in.  
  
P. 38/49 cm.  
D. 14,96 in.  
19,29 in.

### COMPOSIZIONE 32 COMPOSITION 32

PAG. 14 CATALOGO "PROPOSTE ARREDATIVE"  
PAGE 14 "FURNISHING PROPOSALS" CATALOGUE

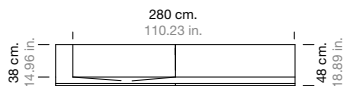

1	<b>DOC3191K</b>	ZOCOCCO L 280 P 45 PLINTH W 280 D 45	<b>409</b>
2	<b>DOC1086K</b>	BASE CESTONE L 140 P 48 DOGA LEGNO LISCIA BASE UNIT WITH BASKET W 140 D 48 PLAIN WOODEN SLAT	<b>2.864</b>
1	<b>DOC5121K</b>	TOP L 280 P 45 TOP W 280 D 45	<b>397</b>
1	<b>DOC2801K</b>	COLONNA A GIORNO SOTTOPENSILE L 20 H 70 CON 2 RIPIANI OPEN TALL UNIT UNDER WALL UNIT W 20 H 70 CON 2 SHELVES	<b>535</b>
2	<b>DOC2811C</b>	MENSOLA DI GIUNZIONE L 40 JOINT SHELF W 40	<b>182</b>
1	<b>DOC2631K</b>	COLONNA A GIORNO SOTTOPENSILE L 20 H 105 CON 2 RIPIANI OPEN TALL UNIT UNDER WALL UNIT W 20 H 105 WITH 2 SHELVES	<b>638</b>
1	<b>DOC2231K</b>	PENSILE ORIZZONTALE 2 ANTE LEGNO L 120 H 60 HORIZONTAL WALL UNIT WITH 2 WOODEN DOORS W 120 H 60 PLAIN	<b>1.479</b>
1	<b>DOC2181K</b>	PENSILE VASISTAS ANTA VETRO L 140 WALL UNIT WITH GLASS LIFT-UP DOOR W 140	<b>1.323</b>
<b>PREZZO TOT. COMPOSIZIONE</b> TOTAL PRICE FOR COMPOSITION			<b>7.827</b>

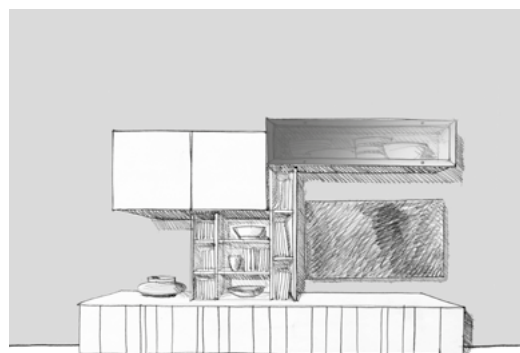
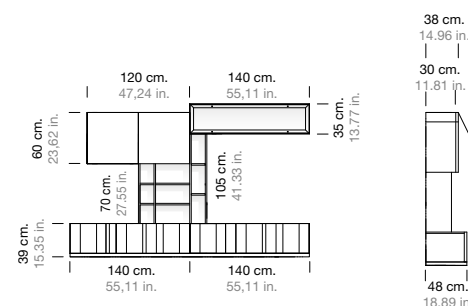

L. 280 cm.  
W. 110,23 in.  
  
P. 38/48 cm.  
D. 14,96 in.  
18,89 in.

### COMPOSIZIONE 34 COMPOSITION 34

PAG. 15 CATALOGO "PROPOSTE ARREDATIVE"  
PAGE 15 "FURNISHING PROPOSALS" CATALOGUE

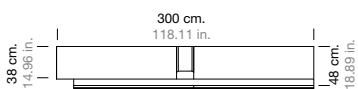

1	<b>DOC3041K</b>	PEDANA L 280 P 49 PLATFORM W 280 D 49	<b>938</b>
2	<b>DOC1086K</b>	BASE CESTONE L 140 P 48 DOGA LEGNO LISCIA BASE UNIT WITH BASKET W 140 D 48 PLAIN WOODEN SLAT	<b>2.864</b>
1	<b>DOC5121K</b>	TOP L 280 P 45 TOP W 280 D 45	<b>397</b>
1	<b>DOC2801K</b>	COLONNA A GIORNO SOTTOPENSILE L 20 H 70 CON 2 RIPIANI OPEN TALL UNIT UNDER WALL UNIT W 20 H 70 WITH 2 SHELVES	<b>535</b>
2	<b>DOC2811C</b>	MENSOLA DI GIUNZIONE L 40 JOINT SHELF W 40	<b>182</b>
1	<b>DOC2951K</b>	COLONNA A GIORNO L 20 H 140 CON 3 RIPIANI OPEN TALL UNIT W 20 H 140 WITH 3 SHELVES	<b>831</b>
1	<b>DOC2171K</b>	PENSILE RIBALTA ANTA LEGNO L 140 WALL UNIT WITH WOODEN DROP-DOWN DOOR W 140 PLAIN	<b>1.197</b>
1	<b>DOC2181K</b>	PENSILE VASISTAS ANTA VETRO L 140 WALL UNIT WITH GLASS LIFT-UP DOOR W 140	<b>1.323</b>
<b>PREZZO TOT. COMPOSIZIONE</b> TOTAL PRICE FOR COMPOSITION			<b>8.267</b>

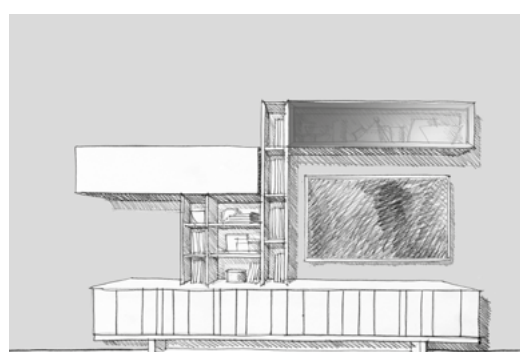
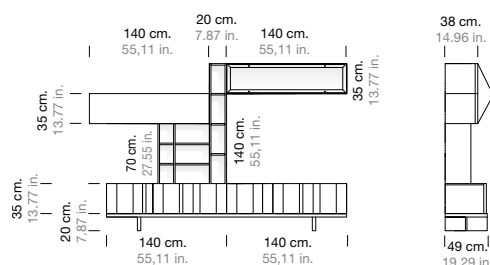

L. 300 cm.  
W. 118,11 in.  
  
P. 38/49 cm.  
D. 14,96 in.  
19,29 in.

# DOMINO SISTEMA COMPONIBILE - MODULAR SYSTEM

## COMPOSIZIONI A CATALOGO

## CATALOGUE COMPOSITIONS

### COMPOSIZIONE 36

#### COMPOSITION 36

PAG. 16 CATALOGO "PROPOSTE ARREDATIVE"  
PAGE 16 "FURNISHING PROPOSALS" CATALOGUE

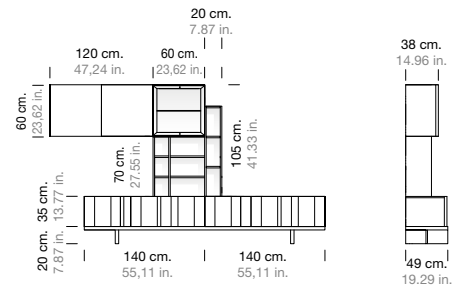
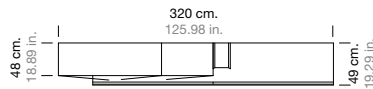

1	<b>DOC3041K</b>	PEDANA L 280 P 49 PLATFORM W 280 D 49	<b>938</b>
2	<b>DOC1086K</b>	BASE CESTONE L 140 P 48 DOGA LEGNO LISCIA BASE UNIT WITH BASKET W 140 D 48 PLAIN WOODEN SLAT	<b>2.864</b>
1	<b>DOC5121K</b>	TOP L 280 P 45 TOP W 280 D 45	<b>397</b>
1	<b>DOC2801K</b>	COLONNA A GIORNO SOTTOPENSILE L 20 H 70 CON 2 RIPIANI OPEN TALL UNIT UNDER WALL UNIT W 20 H 70 CON 2 SHELVES	<b>535</b>
2	<b>DOC2811C</b>	MENSOLA DI GIUNZIONE L 40 JOINT SHELF W 40	<b>182</b>
1	<b>DOC2641K</b>	COLONNA A GIORNO L 20 H 105 CON 2 RIPIANI OPEN TALL UNIT UNDER WALL UNIT W 20 H 105 WITH 2 SHELVES	<b>698</b>
1	<b>DOC2231K</b>	PENSILE ORIZZONTALE 2 ANTE LEGNO L 120 H 60 HORIZONTAL WALL UNIT WITH 2 WOODEN DOORS W 120 H 60	<b>1.479</b>
1	<b>DOC2201K</b>	PENSILE ANTA VETRO DX L 60 H 60 WALL UNIT WITH GLASS DOOR RH W 60 H 60	<b>1.011</b>
<b>PREZZO TOT. COMPOSIZIONE</b> TOTAL PRICE FOR COMPOSITION			<b>8.104</b>

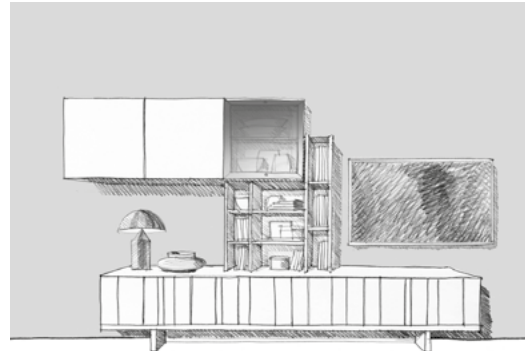

L. 320 cm.  
W. 125,98 in.  
  
P. 38/49 cm.  
D. 14,96 in.  
19,29 in.

### COMPOSIZIONE 38

#### COMPOSITION 38

PAG. 17 CATALOGO "PROPOSTE ARREDATIVE"  
PAGE 17 "FURNISHING PROPOSALS" CATALOGUE

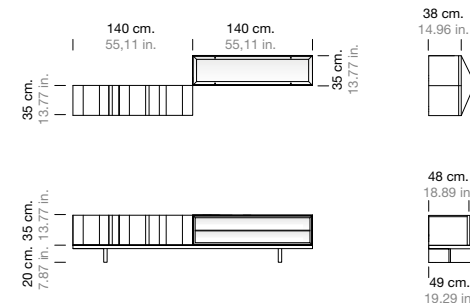
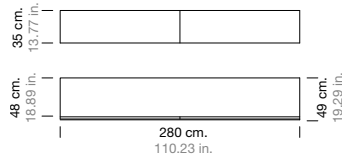

1	<b>DOC3041K</b>	PEDANA L 280 P 49 PLATFORM W 280 D 49	<b>938</b>
1	<b>DOC1086K</b>	BASE CESTONE L 140 P 48 DOGA LEGNO LISCIA BASE UNIT WITH BASKET W 140 D 48 PLAIN WOODEN SLAT	<b>1.432</b>
1	<b>DOC1301K</b>	BASE A GIORNO CON RIPIANO VETRO L 140 P 48 OPEN BASE UNIT WITH GLASS SHELF W 140 D 48	<b>884</b>
1	<b>DOC5121K</b>	TOP L 280 P 45 TOP W 280 D 45	<b>397</b>
1	<b>DOC2176K</b>	PENSILE RIBALTA L 140 DOGA LEGNO LISCIA WALL UNIT DROP-DOWN DOOR W 140 PLAIN WOODEN SLAT	<b>1.564</b>
1	<b>DOC2181K</b>	PENSILE VASISTAS ANTA VETRO L 140 WALL UNIT WITH GLASS LIFT-UP DOOR W 140	<b>1.323</b>
<b>PREZZO TOT. COMPOSIZIONE</b> TOTAL PRICE FOR COMPOSITION			<b>6.538</b>

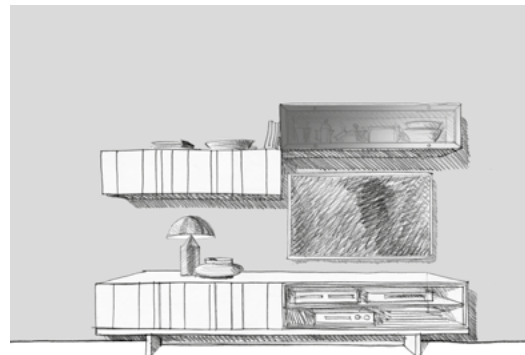

L. 280 cm.  
W. 110,23 in.  
  
P. 38/49 cm.  
D. 14,96 in.  
19,29 in.

### COMPOSIZIONE 42

#### COMPOSITION 42

PAG. 18 CATALOGO "PROPOSTE ARREDATIVE"  
PAGE 18 "FURNISHING PROPOSALS" CATALOGUE

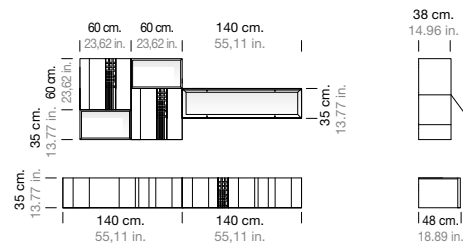
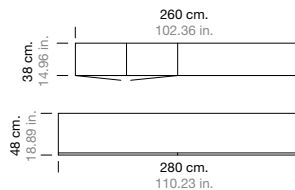

1	<b>DOC1096K</b>	BASE CESTONE SOSPESA L 140 P 48 DOGA LEGNO LISCIA SUSPENDED BASE UNIT WITH BASKET W 140 D 48 PLAIN WOODEN SLAT	<b>1.443</b>
1	<b>DOC1096K</b>	BASE CESTONE SOSPESA L 140 P 48 DOGA QUADRO LEGNO SUSPENDED BASE UNIT WITH BASKET W 140 D 48 SQUARE WOODEN SLAT	<b>1.539</b>
1	<b>DOC5121K</b>	TOP L 280 P 45 TOP W 280 D 45	<b>397</b>
2	<b>DOC2721K</b>	PENSILE A GIORNO L 60 H 35 OPEN WALL UNIT W 60 H 35	<b>974</b>
1	<b>DOC2316K</b>	PENSILE ANTA SX L 60 H 60 DOGA QUADRO LEGNO WALL UNIT WITH DOOR LH W 60 H 60 SQUARE WOODEN SLAT	<b>1.325</b>
1	<b>DOC2216K</b>	PENSILE ANTA DX L 60 H 60 DOGA QUADRO LEGNO WALL UNIT WITH DOOR RH W 60 H 60 SQUARE WOODEN SLAT	<b>1.325</b>
1	<b>DOC2181K</b>	PENSILE VASISTAS ANTA VETRO L 140 WALL UNIT WITH GLASS LIFT-UP DOOR W 140	<b>1.323</b>
<b>PREZZO TOT. COMPOSIZIONE</b> TOTAL PRICE FOR COMPOSITION			<b>8.326</b>

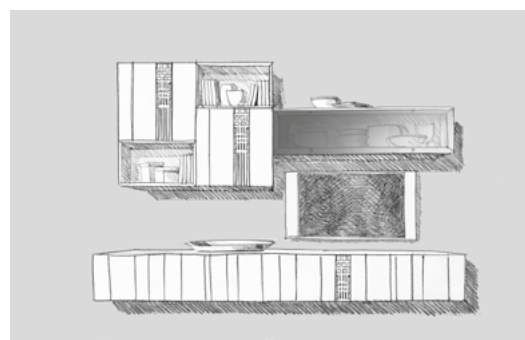

L. 280 cm.  
W. 110,23 in.  
  
P. 38/48 cm.  
D. 14,96 in.  
18,89 in.

## COMPOSIZIONI A CATALOGO CATALOGUE COMPOSITIONS

### COMPOSIZIONE 44 COMPOSITION 44

PAG. 19 CATALOGO "PROPOSTE ARREDATIVE"  
PAGE 19 "FURNISHING PROPOSALS" CATALOGUE

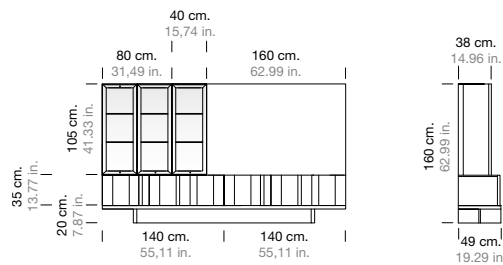

1	<b>DOC3041K</b>	PEDANA L 280 P 49 PLATFORM W 280 D 49	<b>938</b>
2	<b>DOC1086K</b>	BASE CESTONE L 140 P 48 DOGA LEGNO LISCIA BASE UNIT WITH BASKET W 140 D 48 PLAIN WOODEN SLAT	<b>2.864</b>
1	<b>DOC5121K</b>	TOP L 280 P 45 TOP W 280 D 45	<b>397</b>
1	<b>DOC2621K</b>	PENSILE VERTICALE 2 ANTE VETRO L 80 H 105 VERTICAL WALL UNIT WITH 2 GLASS DOORS W 80 H 105	<b>2.116</b>
1	<b>DOC2371K</b>	PENSILE VERTICALE ANTA VETRO SX L 40 H 105 VERTICAL WALL UNIT WITH GLASS DOOR LH W 40 H 105	<b>1.125</b>
1	<b>DOC7081K</b>	BOISERIE L 160 H 105 BOISERIE W 160 H 105	<b>823</b>
<b>PREZZO TOT. COMPOSIZIONE</b> TOTAL PRICE FOR COMPOSITION			<b>8.263</b>

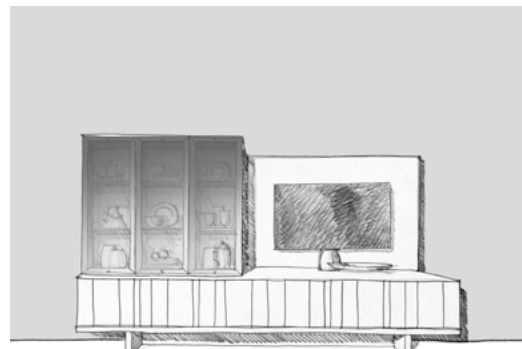

L. 280 cm.  
W. 110,23 in.  
  
P. 38/49 cm.  
D. 14,96 in.  
19,29 in.

### COMPOSIZIONE 46 COMPOSITION 46

PAG. 20 CATALOGO "PROPOSTE ARREDATIVE"  
PAGE 20 "FURNISHING PROPOSALS" CATALOGUE

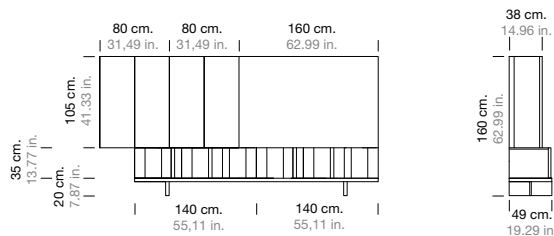

1	<b>DOC3041K</b>	PEDANA L 280 P 49 PLATFORM W 280 D 49	<b>938</b>
2	<b>DOC1086K</b>	BASE CESTONE L 140 P 48 DOGA LEGNO LISCIA BASE UNIT WITH BASKET W 140 D 48 PLAIN WOODEN SLAT	<b>2.864</b>
1	<b>DOC5121K</b>	TOP L 280 P 45 TOP W 280 D 45	<b>397</b>
2	<b>DOC2971K</b>	PENSILE VERTICALE 2 ANTE LEGNO L 80 H 105 VERTICAL WALL UNIT WITH 2 WOODEN DOORS W 80 H 105	<b>3.704</b>
1	<b>DOC7081K</b>	BOISERIE L 160 H 105 BOISERIE W 160 H 105	<b>823</b>
<b>PREZZO TOT. COMPOSIZIONE</b> TOTAL PRICE FOR COMPOSITION			<b>8.726</b>

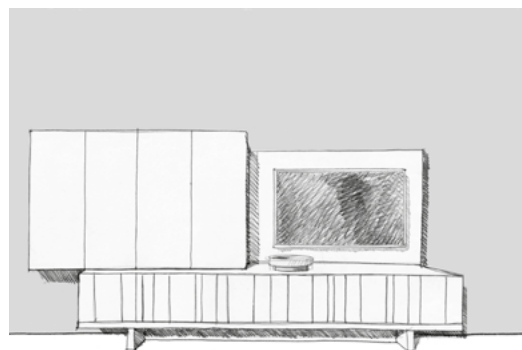

L. 320 cm.  
W. 125,98 in.  
  
P. 38/49 cm.  
D. 14,96 in.  
19,29 in.

### COMPOSIZIONE 48 COMPOSITION 48

PAG. 21 CATALOGO "PROPOSTE ARREDATIVE"  
PAGE 21 "FURNISHING PROPOSALS" CATALOGUE

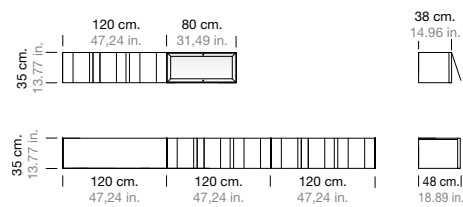
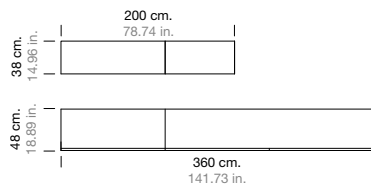

1	<b>DOC1071K</b>	BASE CESTONE SOSPESA L 120 P 48 SUSPENDED BASE UNIT WITH BASKET W 120 D 48	<b>1.070</b>
1	<b>DOC5041K</b>	TOP L 120 P 45 TOP W 120 D 45	<b>175</b>
2	<b>DOC1076K</b>	BASE CESTONE SOSPESA L 120 P 48 DOGA LEGNO LISCIA SUSPENDED BASE UNIT WITH BASKET W 120 D 48 PLAIN WOODEN SLAT	<b>2.730</b>
1	<b>DOC5101K</b>	TOP L 240 P 45 TOP W 240 D 45	<b>349</b>
1	<b>DOC2156K</b>	PENSILE VASISTAS L 120 DOGA LEGNO LISCIA WALL UNIT WITH LIFT-UP DOOR W 120 PLAIN WOODEN SLAT	<b>1.413</b>
1	<b>DOC2101K</b>	PENSILE VASISTAS ANTA VETRO L 80 WALL UNIT WITH GLASS LIFT-UP DOOR W 80	<b>975</b>
<b>PREZZO TOT. COMPOSIZIONE</b> TOTAL PRICE FOR COMPOSITION			<b>6.712</b>

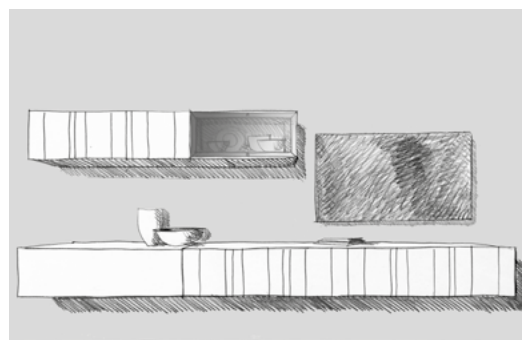

L. 360 cm.  
W. 141,73 in.  
  
P. 38/48 cm.  
D. 14,96 in.  
18,89 in.

# DOMINO SISTEMA COMPONIBILE - MODULAR SYSTEM

## COMPOSIZIONI A CATALOGO

## CATALOGUE COMPOSITIONS

### COMPOSIZIONE 52

#### COMPOSITION 52

PAG. 22 CATALOGO "PROPOSTE ARREDATIVE"  
PAGE 22 "FURNISHING PROPOSALS" CATALOGUE

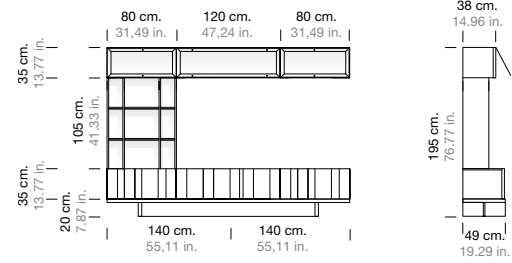
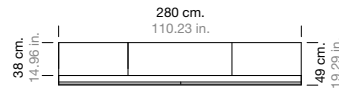

1	<b>DOC3041K</b>	PEDANA L 280 P 49 PLATFORM W 280 D 49	<b>938</b>
2	<b>DOC1086K</b>	BASE CESTONE L 140 P 48 DOGA LEGNO LISCIA BASE UNIT WITH BASKET W 140 D 48 PLAIN WOODEN SLAT	<b>2.864</b>
1	<b>DOC5121K</b>	TOP L 280 P 45 TOP W 280 D 45	<b>397</b>
2	<b>DOC2631K</b>	COLONNA A GIORNO SOTTOPENSILE L 20 H 105 CON 2 RIPIANI OPEN TALL UNIT UNDER WALL UNIT W 20 H 105 WITH 2 SHELVES	<b>1.276</b>
2	<b>DOC2811C</b>	MENSOLA DI GIUNZIONE L 40 JOINT SHELF W 40	<b>182</b>
2	<b>DOC2101K</b>	PENSILE VASISTAS ANTA VETRO L 80 WALL UNIT WITH GLASS LIFT-UP DOOR W 80	<b>1.950</b>
1	<b>DOC2141K</b>	PENSILE VASISTAS ANTA VETRO L 120 WALL UNIT WITH GLASS LIFT-UP DOOR W 120	<b>1.197</b>
<b>PREZZO TOT. COMPOSIZIONE</b> TOTAL PRICE FOR COMPOSITION			<b>8.804</b>

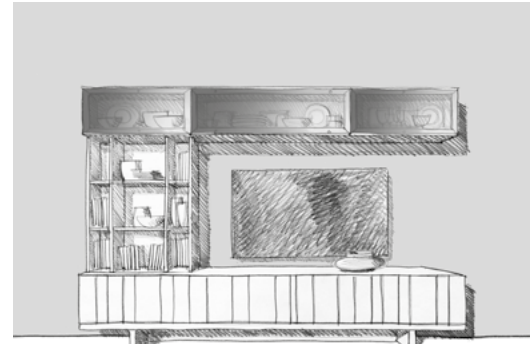

L. 280 cm.  
W. 110,23 in.  
P. 38/49 cm.  
D. 14,96 in.  
19,29 in.

### COMPOSIZIONE 57

#### COMPOSITION 57

PAG. 23 CATALOGO "PROPOSTE ARREDATIVE"  
PAGE 23 "FURNISHING PROPOSALS" CATALOGUE

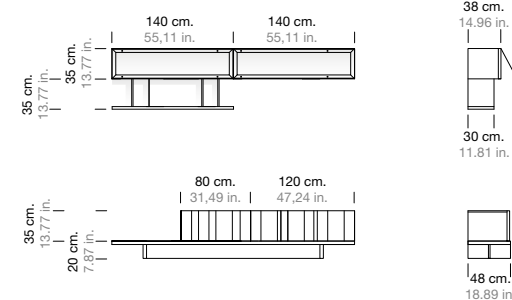

1	<b>DOC3041K</b>	PEDANA L 280 P 49 PLATFORM W 280 D 49	<b>938</b>
1	<b>DOC1046K</b>	BASE CESTONE L 80 P 48 DOGA LEGNO LISCIA BASE UNIT WITH BASKET W 80 D 48 PLAIN WOODEN SLAT	<b>1.160</b>
1	<b>DOC1066K</b>	BASE CESTONE L 120 P 48 DOGA LEGNO LISCIA BASE UNIT WITH BASKET W 120 D 48 PLAIN WOODEN SLAT	<b>1.353</b>
1	<b>DOC5081K</b>	TOP L 200 P 45 TOP W 200 D 45	<b>295</b>
1	<b>DOC3551K</b>	MENSOLA L 140 SHELF W 140	<b>247</b>
2	<b>DOC3981K</b>	DIVISORIO AD U L 20 H 32 U-SHAPED PARTITION W 20 H 32	<b>422</b>
2	<b>DOC2181K</b>	PENSILE VASISTAS ANTA VETRO L 140 WALL UNIT WITH GLASS LIFT-UP DOOR W 140	<b>2.646</b>
<b>PREZZO TOT. COMPOSIZIONE</b> TOTAL PRICE FOR COMPOSITION			<b>7.061</b>

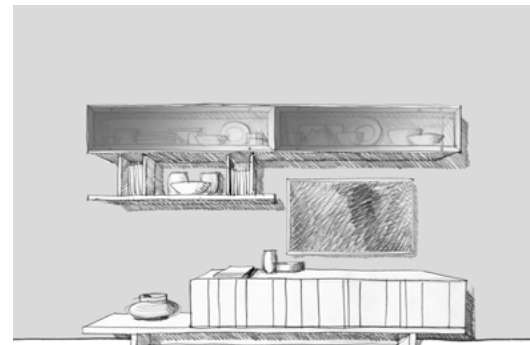

L. 280 cm.  
W. 110,23 in.  
P. 38/49 cm.  
D. 14,96 in.  
19,29 in.

### COMPOSIZIONE 56

#### COMPOSITION 56

PAG. 24 CATALOGO "PROPOSTE ARREDATIVE"  
PAGE 24 "FURNISHING PROPOSALS" CATALOGUE

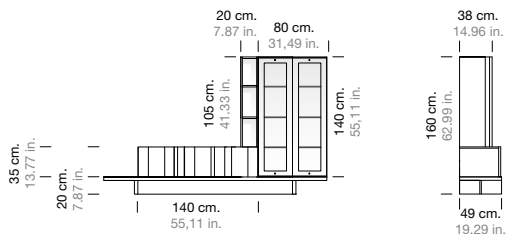
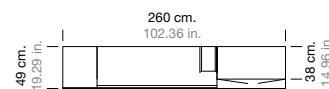

1	<b>DOC3031K</b>	PEDANA L 260 P 49 PLATFORM W 260 D 49	<b>848</b>
1	<b>DOC1086K</b>	BASE CESTONE L 140 P 48 DOGA LEGNO LISCIA BASE UNIT WITH BASKET W 140 D 48 PLAIN WOODEN SLAT	<b>1.432</b>
1	<b>DOC5051K</b>	TOP L 140 P 45 TOP W 140 D 45	<b>206</b>
1	<b>DOC2641K</b>	COLONNA A GIORNO L 20 H 105 CON 2 RIPIANI OPEN TALL UNIT W 20 H 105 WITH 2 SHELVES	<b>698</b>
1	<b>DOC2861K</b>	PENSILE VERTICALE 2 ANTE VETRO L 80 H 140 VERTICAL WALL UNIT WITH 2 GLASS DOORS W 80 H 140	<b>2.314</b>
<b>PREZZO TOT. COMPOSIZIONE</b> TOTAL PRICE FOR COMPOSITION			<b>5.498</b>



L. 260 cm.  
W. 102,36 in.  
P. 38/49 cm.  
D. 14,96 in.  
19,29 in.



## COMPOSIZIONI A CATALOGO CATALOGUE COMPOSITIONS

### COMPOSIZIONE 59

#### COMPOSITION 59

PAG. 25 CATALOGO "PROPOSTE ARREDATIVE"  
PAGE 25 "FURNISHING PROPOSALS" CATALOGUE

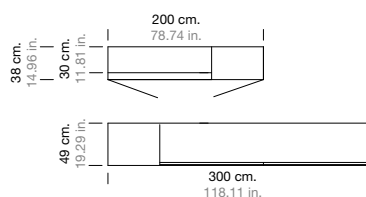

1	<b>DOC3051K</b>	PEDANA L 300 P 49 PLATFORM W 300 D 49	<b>999</b>
2	<b>DOC1066K</b>	BASE CESTONE L 120 P 48 DOGA RIGHE BASE UNIT WITH BASKET W 120 D 48 RIBBED SLAT	<b>2.840</b>
1	<b>DOC5101K</b>	TOP L 240 P 45 TOP W 240 D 45	<b>349</b>
1	<b>DOC2311K</b>	PENSILE ANTA LEGNO SX L 60 H 60 WALL UNIT WITH WOODEN DOOR LH W 60 H 60	<b>848</b>
1	<b>DOC2191K</b>	PENSILE VASISTAS ANTA LEGNO L 140 WALL UNIT WITH WOODEN LIFT-UP DOOR W 140	<b>1.119</b>
2	<b>DOC3981K</b>	DIVISORIO AD U L 20 H 32 U-SHAPED PARTITION W 20 H 32	<b>422</b>
1	<b>DOC3551K</b>	MENSOLA L 140 SHELF W 140	<b>247</b>
1	<b>DOC2291K</b>	PENSILE ANTA VETRO DX L 60 H 70 WALL UNIT WITH GLASS DOOR RH W 60 H 70	<b>1.047</b>
<b>PREZZO TOT. COMPOSIZIONE</b> TOTAL PRICE FOR COMPOSITION			<b>7.871</b>

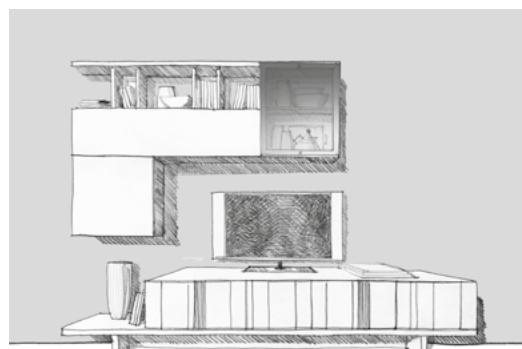
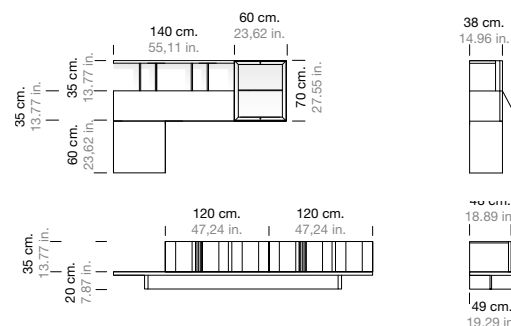

L. 300 cm.  
W. 118,11 in.  
P. 38/49 cm.  
D. 14,96 in.  
19,29 in.

### COMPOSIZIONE 62

#### COMPOSITION 62

PAG. 26 CATALOGO "PROPOSTE ARREDATIVE"  
PAGE 26 "FURNISHING PROPOSALS" CATALOGUE

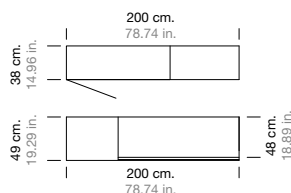

1	<b>DOC3001K</b>	PEDANA L 200 P 49 PLATFORM W 200 D 49	<b>692</b>
1	<b>DOC1086K</b>	BASE CESTONE L 140 P 48 DOGA LEGNO LISCIA BASE UNIT WITH BASKET W 140 D 48 PLAIN WOODEN SLAT	<b>1.432</b>
1	<b>DOC5051K</b>	TOP L 140 P 45 TOP W 140 D 45	<b>206</b>
1	<b>DOC2311K</b>	PENSILE ANTA LEGNO SX L 60 H 60 WALL UNIT WITH WOODEN DOOR LH W 60 H 60	<b>848</b>
1	<b>DOC2156K</b>	PENSILE VASISTAS L 120 DOGA LEGNO LISCIA WALL UNIT WITH LIFT-UP DOOR W 120 PLAIN WOODEN SLAT	<b>1.413</b>
1	<b>DOC2101K</b>	PENSILE VASISTAS ANTA VETRO L 80 WALL UNIT WITH GLASS LIFT-UP DOOR W 80	<b>975</b>
<b>PREZZO TOT. COMPOSIZIONE</b> TOTAL PRICE FOR COMPOSITION			<b>5.566</b>

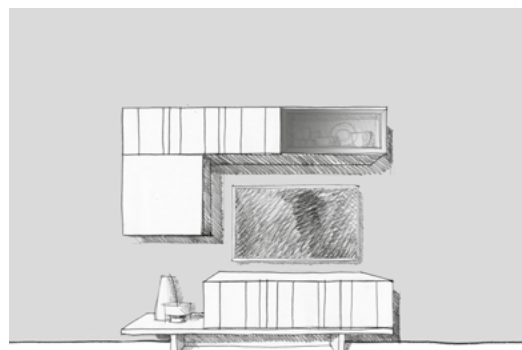
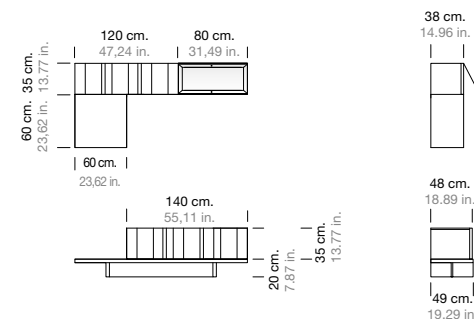

L. 200 cm.  
W. 102,36 in.  
P. 38/49 cm.  
D. 14,96 in.  
19,29 in.

### COMPOSIZIONE 66

#### COMPOSITION 66

PAG. 28 CATALOGO "PROPOSTE ARREDATIVE"  
PAGE 28 "FURNISHING PROPOSALS" CATALOGUE

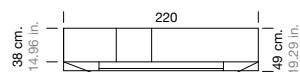

1	<b>DOC3011K</b>	PEDANA L 220 P 49 PLATFORM W 220 D 49	<b>746</b>
1	<b>DOC1086K</b>	BASE CESTONE L 140 P 48 DOGA RIGHE BASE UNIT WITH BASKET W 140 D 48 RIBBED SLAT	<b>1.499</b>
1	<b>DOC5051K</b>	TOP L 140 P 45 TOP W 140 D 45	<b>206</b>
1	<b>DOC2511K</b>	PENSILE VERTICALE ANTA VETRO SX L 40 H 140 VERTICAL WALL UNIT WITH GLASS DOOR LH W 40 H 140	<b>1.275</b>
1	<b>DOC2411K</b>	PENSILE VERTICALE ANTA VETRO DX L 40 H 140 VERTICAL WALL UNIT WITH GLASS DOOR RH W 40 H 140	<b>1.275</b>
1	<b>DOC2071K</b>	PENSILE VASISTAS ANTA LEGNO L 60 WALL UNIT WITH WOODEN LIFT-UP DOOR W 60	<b>735</b>
1	<b>DOC2151K</b>	PENSILE VASISTAS ANTA LEGNO L 120 WALL UNIT WITH WOODEN LIFT-UP DOOR W 120	<b>1.047</b>
1	<b>DOC2711K</b>	PENSILE A GIORNO L 40 H 35 OPEN WALL UNIT W 40 H 35	<b>427</b>
<b>PREZZO TOT. COMPOSIZIONE</b> TOTAL PRICE FOR COMPOSITION			<b>7.210</b>

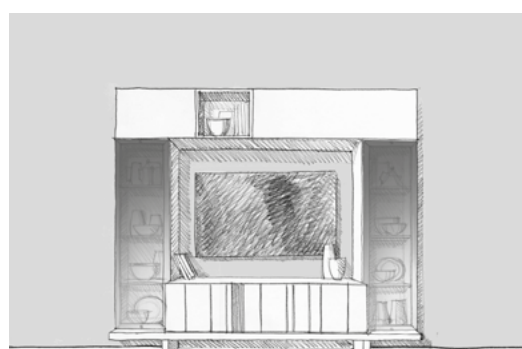
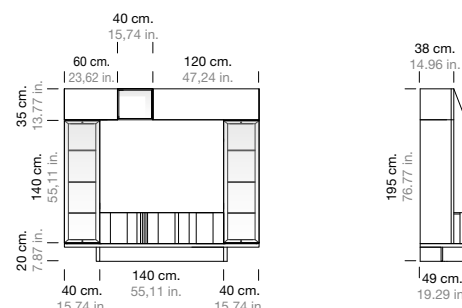

L. 220 cm.  
W. 86,61 in.  
P. 38/48 cm.  
D. 14,96 in.  
18,89 in.

# DOMINO SISTEMA COMPONIBILE - MODULAR SYSTEM

## COMPOSIZIONI A CATALOGO

## CATALOGUE COMPOSITIONS

### COMPOSIZIONE 68

### COMPOSITION 68

PAG. 29 CATALOGO "PROPOSTE ARREDATIVE"  
PAGE 29 "FURNISHING PROPOSALS" CATALOGUE

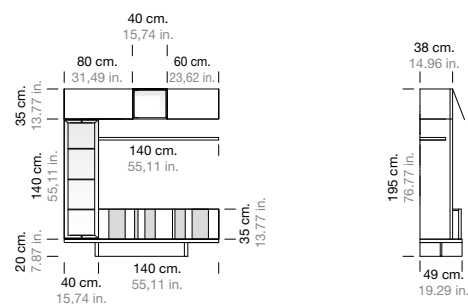
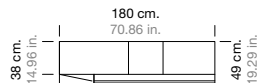

1	<b>DOC3000K</b>	PEDANA L 180 P 49 PLATFORM W 180 D 49	<b>650</b>
1	<b>DOC1086K</b>	BASE CESTONE L 140 P 48 DOGA LEGNO LISCIA - MULTICOLOR BASE UNIT WITH BASKET W 140 D 48 PLAIN WOODEN SLAT - MULTICOLOR	<b>1.504</b>
1	<b>DOC5051K</b>	TOP L 140 P 45 TOP W 140 D 45	<b>206</b>
1	<b>DOC2511K</b>	PENSILE VERTICALE ANTA VETRO SX L 40 H 140 VERTICAL WALL UNIT WITH GLASS DOOR LH W 40 H 140	<b>1.275</b>
1	<b>DOC3551K</b>	MENSOLA L 140 SHELF W 140	<b>247</b>
1	<b>DOC2111K</b>	PENSILE VASISTAS ANTA LEGNO L 80 WALL UNIT WITH WOODEN LIFT-UP DOOR W 80	<b>884</b>
1	<b>DOC2071K</b>	PENSILE VASISTAS ANTA LEGNO L 60 WALL UNIT WITH WOODEN LIFT-UP DOOR W 60	<b>735</b>
1	<b>DOC2711K</b>	PENSILE A GIORNO L 40 H 35 OPEN WALL UNIT W 40 H 35	<b>427</b>
<b>PREZZO TOT. COMPOSIZIONE</b> TOTAL PRICE FOR COMPOSITION			<b>5.928</b>

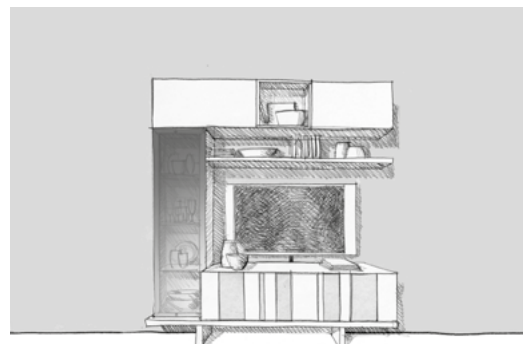

L. 180 cm.  
W. 70,86 in.  
P. 38/49 cm.  
D. 14,96 in.  
19,29 in.

### COMPOSIZIONE 72/A

### COMPOSITION 72/A

PAG. 30 CATALOGO "PROPOSTE ARREDATIVE"  
PAGE 30 "FURNISHING PROPOSALS" CATALOGUE

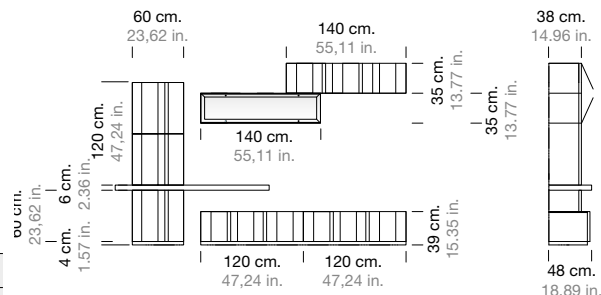
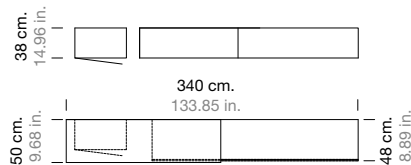

1	<b>DOC3171K</b>	ZOCCOLO L 240 P 45 PLINTH W 240 D 45	<b>349</b>
2	<b>DOC1066K</b>	BASE CESTONE L 120 P 48 DOGA LEGNO LISCIA BASE UNIT WITH BASKET W 120 D 48 PLAIN WOODEN SLAT	<b>2.706</b>
1	<b>DOC5101K</b>	TOP L 240 P 45 TOP W 240 D 45	<b>349</b>
1	<b>DOC3231K</b>	ZOCCOLO L 60 P 35 PLINTH W 60 D 35	<b>181</b>
1	<b>DOC2316K</b>	PENSILE ANTA SX L 60 H 60 DOGA LEGNO LISCIA WALL UNIT WITH DOOR LH W 60 H 60 PLAIN WOODEN SLAT	<b>1.215</b>
1	<b>DOC2686K</b>	PENSILE VERTICALE 2 ANTE SX L 60 H 120 DOGA LEGNO LISCIA VERTICAL WALL UNIT WITH 2 DOORS RH W 60 H 120 PLAIN WOODEN SLAT	<b>2.146</b>
1	<b>DOC3741K</b>	MENSOLONE L 180 P 50 LARGE SHELF W 180 D 50	<b>668</b>
1	<b>DOC2196K</b>	PENSILE VASISTAS L 140 DOGA LEGNO LISCIA WALL UNIT WITH LIFT-UP DOOR W 140 PLAIN WOODEN SLAT	<b>1.473</b>
1	<b>DOC2161K</b>	PENSILE RIBALTA ANTA VETRO L 140 WALL UNIT WITH GLASS DROP-DOWN DOOR W 140	<b>1.401</b>
<b>PREZZO TOT. COMPOSIZIONE</b> TOTAL PRICE FOR COMPOSITION			<b>10.488</b>



L. 340 cm.  
W. 133,85 in.  
P. 38/48 cm.  
D. 14,96 in.  
18,89 in.

### COMPOSIZIONE 74

### COMPOSITION 74

PAG. 32 CATALOGO "PROPOSTE ARREDATIVE"  
PAGE 32 "FURNISHING PROPOSALS" CATALOGUE

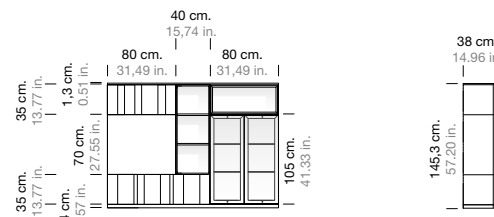

1	<b>DOC3301K</b>	ZOCCOLO L 200 P 35 PLINTH W 200 D 35	<b>326</b>
1	<b>DOC1376K</b>	BASE CESTONE L 120 P 38 DOGA LEGNO LISCIA BASE UNIT WITH BASKET W 120 D 38 PLAIN WOODEN SLAT	<b>1.341</b>
1	<b>DOC2621K</b>	PENSILE VERTICALE 2 ANTE VETRO L 80 H 105 VERTICAL WALL UNIT WITH 2 GLASS DOORS W 80 H 105	<b>2.116</b>
1	<b>DOC2541K</b>	PENSILE ORIZZONTALE ANTA LEGNO SX L 80 H 70 HORIZONTAL WALL UNIT WITH WOODEN DOOR LH W 80 H 70	<b>981</b>
1	<b>DOC2741K</b>	PENSILE A GIORNO L 40 H 105 OPEN TALL UNIT W 40 H 105	<b>662</b>
1	<b>DOC2096K</b>	PENSILE RIBALTA L 80 DOGA LEGNO LISCIA WALL UNIT WITH DROP-DOWN DOOR W 80 PLAIN WOODEN SLAT	<b>1.167</b>
1	<b>DOC2771K</b>	PENSILE A GIORNO CON CORNICE L 80 P 38 OPEN WALL UNIT WITH FRAME W 80 D 38	<b>722</b>
1	<b>DOC5371K</b>	TOP PER PENSILI L 200 P 38 TOP W 200 D 38	<b>289</b>
<b>PREZZO TOT. COMPOSIZIONE</b> TOTAL PRICE FOR COMPOSITION			<b>7.604</b>

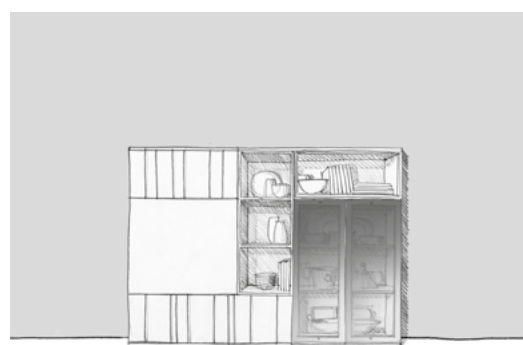

L. 200 cm.  
W. 78,74 in.  
P. 38 cm.  
D. 14,96 in.

## COMPOSIZIONI A CATALOGO CATALOGUE COMPOSITIONS

### COMPOSIZIONE 76 COMPOSITION 76

PAG. 33 CATALOGO "PROPOSTE ARREDATIVE"  
PAGE 33 "FURNISHING PROPOSALS" CATALOGUE

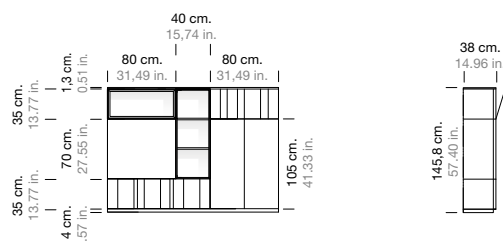
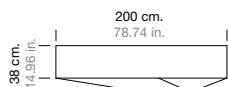

1	<b>DOC3301K</b>	ZOCCOLO L 200 P 35 PLINTH W 200 D 35	<b>326</b>
1	<b>DOC1376K</b>	BASE CESTONE L 120 P 38 DOGA LEGNO LISCIA BASE UNIT WITH BASKET W 120 D 38 PLAIN WOODEN SLAT	<b>1.341</b>
1	<b>DOC2971K</b>	PENSILE VERTICALE 2 ANTE LEGNO L 80 H 105 VERTICAL WALL UNIT WITH 2 WOODEN DOORS W 80 H 105	<b>1.852</b>
1	<b>DOC2541K</b>	PENSILE ORIZZONTALE ANTA LEGNO SX L 80 H 70 HORIZONTAL WALL UNIT WITH WOODEN DOOR LH W 80 H 70	<b>981</b>
1	<b>DOC2741K</b>	PENSILE A GIORNO L 40 H 105 OPEN TALL UNIT W 40 H 105	<b>662</b>
1	<b>DOC2096K</b>	PENSILE RIBALTA L 80 DOGA LEGNO LISCIA WALL UNIT WITH DROP-DOWN DOOR W 80 PLAIN WOODEN SLAT	<b>1.167</b>
1	<b>DOC2771K</b>	PENSILE A GIORNO CON CORNICE L 80 P 38 OPEN WALL UNIT WITH FRAME W 80 D 38	<b>722</b>
1	<b>DOC5371K</b>	TOP PER PENSILI L 200 P 38 TOP W 200 D 38	<b>289</b>
<b>PREZZO TOT. COMPOSIZIONE</b> TOTAL PRICE FOR COMPOSITION			<b>7.340</b>

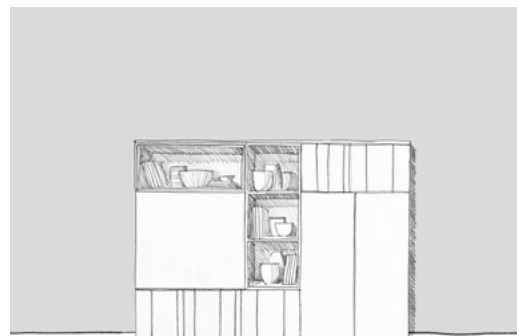

L. 200 cm.  
W. 102,36 in.  
  
P. 38 cm.  
D. 14,96 in.

### COMPOSIZIONE 78 COMPOSITION 78

PAG. 34 CATALOGO "PROPOSTE ARREDATIVE"  
PAGE 34 "FURNISHING PROPOSALS" CATALOGUE

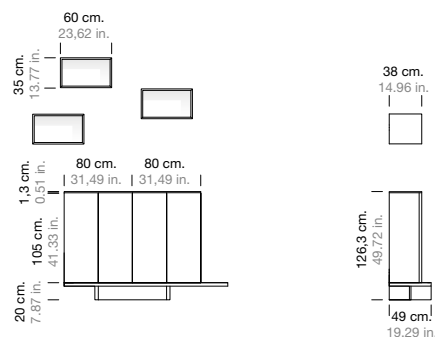

1	<b>DOC3001K</b>	PEDANA L 200 P 49 PLATFORM W 200 D 49	<b>692</b>
2	<b>DOC2971K</b>	PENSILE VERTICALE 2 ANTE LEGNO L 80 H 105 VERTICAL WALL UNIT WITH 2 WOODEN DOORS W 80 H 105	<b>3.704</b>
1	<b>DOC5351K</b>	TOP PER MADIE COMPONIBILI L 160 P 38 TOP FOR MODULAR CUPBOARDS W 160 D 38	<b>253</b>
3	<b>DOC2721K</b>	PENSILE A GIORNO L 60 H 35 OPEN WALL UNIT W 60 H 35	<b>1.461</b>
<b>PREZZO TOT. COMPOSIZIONE</b> TOTAL PRICE FOR COMPOSITION			<b>6.110</b>

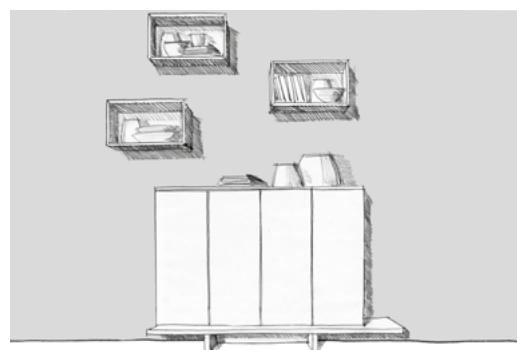

L. 200 cm.  
W. 102,36 in.  
  
P. 38/49 cm.  
D. 14,96 in.  
19,29 in.

### COMPOSIZIONE 80 COMPOSITION 80

PAG. 35 CATALOGO "PROPOSTE ARREDATIVE"  
PAGE 35 "FURNISHING PROPOSALS" CATALOGUE

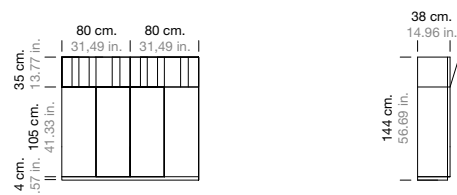
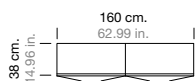

1	<b>DOC3281K</b>	ZOCCOLO L 160 P 35 PLINTH W 160 D 35	<b>259</b>
2	<b>DOC2971K</b>	PENSILE VERTICALE 2 ANTE LEGNO L 80 H 105 VERTICAL WALL UNIT WITH 2 WOODEN DOORS W 80 H 105	<b>3.704</b>
2	<b>DOC2096K</b>	PENSILE RIBALTA L 80 DOGA LEGNO LISCIA WALL UNIT WITH DROP-DOWN DOOR W 80 PLAIN WOODEN SLAT	<b>2.334</b>
<b>PREZZO TOT. COMPOSIZIONE</b> TOTAL PRICE FOR COMPOSITION			<b>6.297</b>

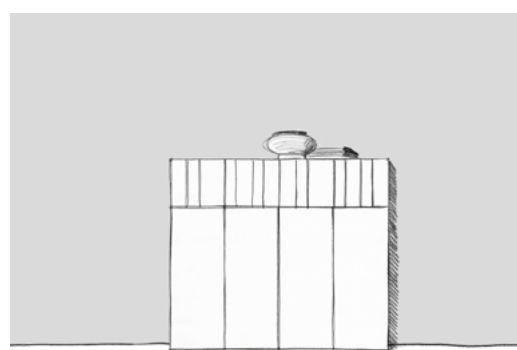

L. 180 cm.  
W. 70,86 in.  
  
P. 38 cm.  
D. 14,96 in.





**03** \_ GIORNO E NOTTE  
DAY AND NIGHT

**107** \_ SISTEMA COMPONIBILE BOOK  
BOOK MODULAR SYSTEM

**127** \_ SISTEMA COMPONIBILE DOMINO  
DOMINO MODULAR SYSTEM

**179** \_ DIVANO COMPONIBILE PENTA  
PENTA MODULAR SOFA

**180** BASI A TERRA H. 45 CM.  
FLOOR BASES H. 15,74 IN.

**180** SCHIENALI MOBILI H. 25  
MOVABLE BACKREST H. 9,84 IN.

**182** COMPOSIZIONI  
COMPOSITIONS

# DIVANO componibile PENTA - PENTA MODULAR SOFA

**BASI A TERRA H. 45 CM.**  
**FLOOR BASES H. 15,74 IN.**

**NEW**

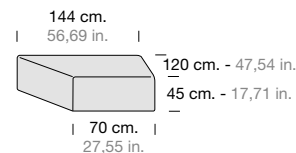
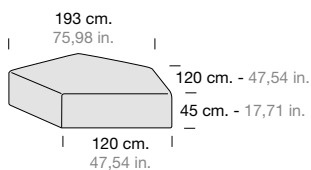

CML9075K		
CAT. A	CAT. B	CAT. C
ECOPELLE/ECONABUK FAUX LEATHER/ECONABUK	LINO/VELLUTO LINEN/VELVET	PELLE LEATHER
<b>2.794</b>	<b>2.980</b>	<b>4.069</b>

CML9077K		
CAT. A	CAT. B	CAT. C
ECOPELLE/ECONABUK FAUX LEATHER/ECONABUK	LINO/VELLUTO LINEN/VELVET	PELLE LEATHER
<b>2.698</b>	<b>2.807</b>	<b>3.441</b>

mc 1,30 – Kg 100

mc 1,00 – Kg 85

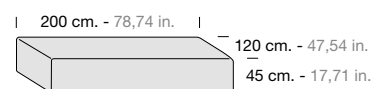
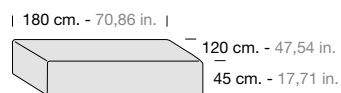

CML9073K		
CAT. A	CAT. B	CAT. C
ECOPELLE/ECONABUK FAUX LEATHER/ECONABUK	LINO/VELLUTO LINEN/VELVET	PELLE LEATHER
<b>2.635</b>	<b>2.775</b>	<b>3.592</b>

CML9074K		
CAT. A	CAT. B	CAT. C
ECOPELLE/ECONABUK FAUX LEATHER/ECONABUK	LINO/VELLUTO LINEN/VELVET	PELLE LEATHER
<b>2.947</b>	<b>3.087</b>	<b>3.903</b>

mc 1,25 – Kg 95

mc 1,40 – Kg 105

**SCHIENALI MOBILI H. 25**  
**MOVABLE BACKREST H. 9,84 IN.**

**NEW**

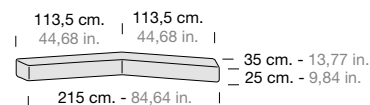
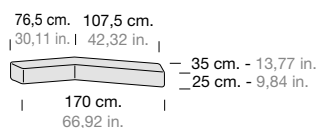

CML9205K		
CAT. A	CAT. B	CAT. C
ECOPELLE/ECONABUK FAUX LEATHER/ECONABUK	LINO/VELLUTO LINEN/VELVET	PELLE LEATHER
<b>1.771</b>	<b>1.833</b>	<b>2.194</b>

CML9206K		
CAT. A	CAT. B	CAT. C
ECOPELLE/ECONABUK FAUX LEATHER/ECONABUK	LINO/VELLUTO LINEN/VELVET	PELLE LEATHER
<b>1.836</b>	<b>1.914</b>	<b>2.369</b>

mc 0,25 – Kg 40

mc 0,35 – Kg 50

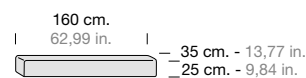

CML9203K		
CAT. A	CAT. B	CAT. C
ECOPELLE/ECONABUK FAUX LEATHER/ECONABUK	LINO/VELLUTO LINEN/VELVET	PELLE LEATHER
<b>1.329</b>	<b>1.391</b>	<b>1.753</b>

CML9204K		
CAT. A	CAT. B	CAT. C
ECOPELLE/ECONABUK FAUX LEATHER/ECONABUK	LINO/VELLUTO LINEN/VELVET	PELLE LEATHER
<b>1.395</b>	<b>1.472</b>	<b>1.927</b>

mc 0,13 – Kg 22

mc 0,17 – Kg 28

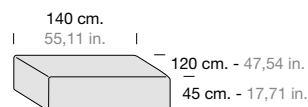
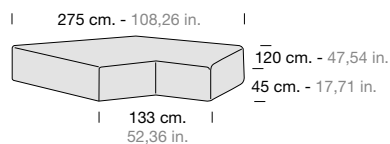

CML9076K		
CAT. A	CAT. B	CAT. C
ECOPELLE/ECONABUK FAUX LEATHER/ECONABUK	LINO/VELLUTO LINEN/VELVET	PELLE LEATHER
<b>3.212</b>	<b>3.383</b>	<b>4.378</b>
mc 1,80 – Kg 240		

CML9072K		
CAT. A	CAT. B	CAT. C
ECOPELLE/ECONABUK FAUX LEATHER/ECONABUK	LINO/VELLUTO LINEN/VELVET	PELLE LEATHER
<b>2.082</b>	<b>2.207</b>	<b>2.930</b>
mc 0,90 – Kg 180		

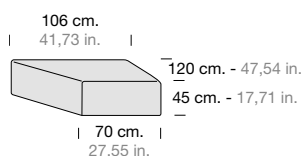

CML9078K		
CAT. A	CAT. B	CAT. C
ECOPELLE/ECONABUK FAUX LEATHER/ECONABUK	LINO/VELLUTO LINEN/VELVET	PELLE LEATHER
<b>1.994</b>	<b>2.087</b>	<b>2.631</b>
mc 0,70 – Kg 65		

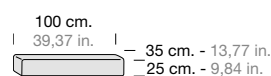
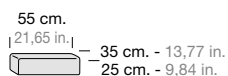

CML9201K		
CAT. A	CAT. B	CAT. C
ECOPELLE/ECONABUK FAUX LEATHER/ECONABUK	LINO/VELLUTO LINEN/VELVET	PELLE LEATHER
<b>593</b>	<b>624</b>	<b>807</b>
mc 0,06 – Kg 13		

CML9202K		
CAT. A	CAT. B	CAT. C
ECOPELLE/ECONABUK FAUX LEATHER/ECONABUK	LINO/VELLUTO LINEN/VELVET	PELLE LEATHER
<b>907</b>	<b>953</b>	<b>1.225</b>
mc 0,10 – Kg 20		

## TAVOLINO PENTA PENTA COFFEE TABLE

**NEW**

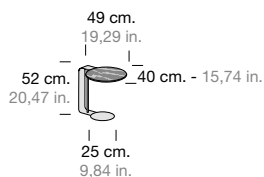

PIANO IN MARMO  
MARBLE TOP

PIANO IN CERAMICA  
CERAMIC TOP

FBG4550K	FBG4551K
ECOPELLE/ECONABUK FAUX LEATHER/ECONABUK	ECOPELLE/ECONABUK FAUX LEATHER/ECONABUK
<b>1.610</b>	<b>1.500</b>
mc 0,07 – Kg 20	mc 0,07 – Kg 20

## PORTA RIVISTE MAGAZINE RACK

**NEW**

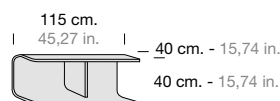

FBG9011K
<b>2.470</b>
mc 0,22 – Kg 20

# DIVANO componibile PENTA - PENTA MODULAR SOFA

## COMPOSIZIONI COMPOSITIONS

**NEW**

### COMPOSIZIONE - MILANO 2023 COMPOSITION - MILANO 2023

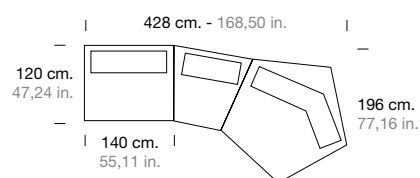

CML9306K		
CAT. A	CAT. B	CAT. C
ECOPELLE/ECONABUK FAUX LEATHER/ECONABUK	LINO/VELLUTO LINEN/VELVET	PELLE LEATHER
<b>11.580</b>	<b>12.170</b>	<b>15.612</b>

mc 3,38 – Kg 427

### COMPOSIZIONE - A COMPOSITION - A

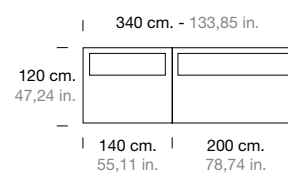

CML9077K		
CAT. A	CAT. B	CAT. C
ECOPELLE/ECONABUK FAUX LEATHER/ECONABUK	LINO/VELLUTO LINEN/VELVET	PELLE LEATHER
<b>7.687</b>	<b>8.076</b>	<b>10.339</b>

mc 2,60 – Kg 335

### COMPOSIZIONE - B COMPOSITION - B

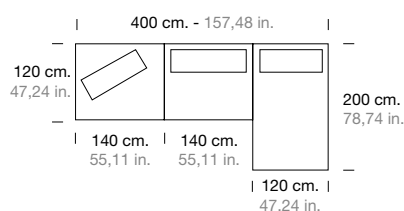

CML9302K		
CAT. A	CAT. B	CAT. C
ECOPELLE/ECONABUK FAUX LEATHER/ECONABUK	LINO/VELLUTO LINEN/VELVET	PELLE LEATHER
<b>10.254</b>	<b>10.798</b>	<b>13.966</b>

mc 3,53 – Kg 527

### COMPOSIZIONE - C COMPOSITION - C

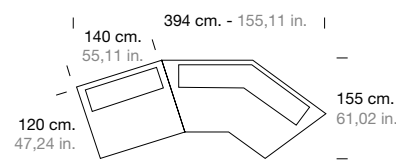

CML9303K		
CAT. A	CAT. B	CAT. C
ECOPELLE/ECONABUK FAUX LEATHER/ECONABUK	LINO/VELLUTO LINEN/VELVET	PELLE LEATHER
<b>8.437</b>	<b>8.887</b>	<b>11.511</b>

mc 3,18 – Kg 492

### COMPOSIZIONE - E COMPOSITION - E

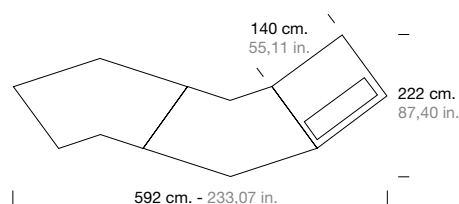

CML9304K		
CAT. A	CAT. B	CAT. C
ECOPELLE/ECONABUK FAUX LEATHER/ECONABUK	LINO/VELLUTO LINEN/VELVET	PELLE LEATHER
<b>13.463</b>	<b>14.176</b>	<b>18.339</b>

mc 4,63 – Kg 682

### COMPOSIZIONE - MILANO 2022 COMPOSITION - MILANO 2022

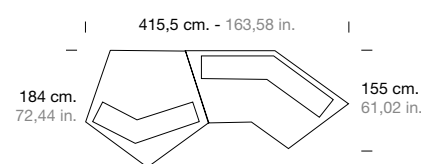

CML9305K		
CAT. A	CAT. B	CAT. C
ECOPELLE/ECONABUK FAUX LEATHER/ECONABUK	LINO/VELLUTO LINEN/VELVET	PELLE LEATHER
<b>9.613</b>	<b>10.110</b>	<b>13.010</b>

mc 3,70 – Kg 430





**PREZZI DA APPLICARE PER PRODOTTI FUORI STANDARD O "SU MISURA"**

**COSA SI DEVE INTENDERE PER FUORI STANDARD:**

SI INTENDONO TUTTI I PRODOTTI A LISTINO CON DIMENSIONI INFERIORI RISPETTO A QUANTO ESPOSTO NEL MEDESIMO.

PER TALI PRODOTTI DOVRANNO ESSERE APPLICATE LE SEGUENTI MAGGIORAZIONI:

- + 30 %** RISPETTO AL PREZZO DI LISTINO PER UN SOLO TAGLIO (ES: LARGHEZZA, PROFONDITÀ O ALTEZZA)
- + 40 %** RISPETTO AL PREZZO DI LISTINO SE LE RIDUZIONI SONO DI 2 O 3 TAGLI (ES: LARGHEZZA E PROFONDITÀ O LARGHEZZA E ALTEZZA ECC)

**PER RICHIESTE DI PRODOTTI CON DIMENSIONI SUPERIORI RISPETTO A QUELLE STANDARD DEL LISTINO DEVE ESSERE RICHIESTO IL PREVENTIVO ALL'AZIENDA, IN QUANTO COMPORTA MOLTE VARIABILI.**

**PER MODIFICHE RELATIVE ALLA LUCIDATURA DOVRANNO ESSERE CONSIDERATE LE SEGUENTI MAGGIORAZIONI:**

- + 10 %** PER LACCATO OPACO COPRENTE COLORI DA CAMPIONARIO MODO10
- + 10 %** PER FINITURA VERNICIATA A CAMPIONE

**GLI ORDINI CON MISURE SPECIALI, ACCETTATI DALL'AZIENDA, SI DEVONO RITENERE IRREVOCABILI.**

**SI RICHIEDE INOLTRE PER GLI STESSI UN PAGAMENTO ANTICIPATO ALL'ORDINE PARI AL 30% DELL'IMPORTO DOVUTO.**

**PER CONSEGNE DI IMPORTI INFERIORI A 600 EURO NETTI A MEZZO BIANCHINI SRL, È PREVISTO UN CONTRIBUTO SPESE DI TRASPORTO PARI A 60 EURO.**

**PER CONSEGNE DI IMPORTI INFERIORI A 600 EURO NETTI A MEZZO CORRIERE ESPRESSO, VERRÀ CALCOLATO IL PREZZO DEL CORRIERE**

**PER IMBALLO IN CASSE DI LEGNO CALCOLARE UNA MAGGIORAZIONE SUL PREZZO DI LISTINO DI +15%**

**PRICES FOR OUT OF STANDARD OR "MADE-TO-MEASURE" PRODUCTS**

**WHAT DO YOU MEAN FOR OUT OF STANDARD:**

THIS REFERS TO ALL PRODUCTS IN THE PRICE LIST WITH SMALLER DIMENSIONS THAT THOSE GIVEN.

FOR THESE PRODUCTS THE FOLLOWING SURCHARGES ARE APPLICABLE:

- + 30 %** ON THE LIST PRICE FOR A SINGLE CUTTING OPERATION (E.G. WIDTH, DEPTH OR HEIGHT).
- + 40 %** ON THE LIST PRICE IF THERE ARE 2 OR 3 CUTTING OPERATIONS (E.G. WIDTH AND DEPTH OR WIDTH AND HEIGHT, ETC.)

**FOR PRODUCTS BIGGER THAN STANDARD IN THE PRICE LIST, PLEASE APPLY TO THE COMPANY FOR AN ESTIMATE, AS MANY VARIABLES ARE INVOLVED.**

**FOR POLISHING MODIFICATIONS CONSIDER THE FOLLOWING SURCHARGES:**

- + 10 %** FOR ONE-COAT PAINTED FINISH IN MATT MODO10 SAMPLER
- + 10 %** FOR SAMPLE PAINTED FINISH

**WHEN ORDERS FOR SPECIAL MEASUREMENTS ARE ACCEPTED BY THE COMPANY, THEY ARE IRREVOCABLE.**

**WHEN SUCH ORDERS ARE PLACED AN ADVANCE PAYMENT OF 30% OF THE AMOUNT DUE IS REQUIRED.**

**FOR DELIVERIES AMOUNTING TO LESS THAN 600 EURO (NET PRICE), A 60 EURO CONTRIBUTION TO THE TRANSPORT COSTS IS FORESEEN.**

**FOR DELIVERIES OF AMOUNTS LESS THAN 600 EUROS NET BY EXPRESS COURIER, THE COURIER PRICE WILL BE CALCULATED**

**FOR PACKAGING IN WOODEN CRATES CALCULATE AN INCREASE ON THE LIST PRICE OF + 15%**

## CONDIZIONI GENERALI DI VENDITA

---

VALIDITÀ: IL PRESENTE LISTINO ANNULLA E SOSTITUISCE TUTTI I PRECEDENTI A DECORRE DAL 1 APRILE 2024.

LA BIANCHINI S.R.L. SI RISERVA IL DIRITTO DI APPORTARVI IN QUALUNQUE MOMENTO E SENZA PREAVVISO TUTTE LE MODIFICHE CHE SI RENDONO OPPORTUNE, DECLINANDO OGNI RESPONSABILITÀ PER EVENTUALI INESATTEZZE IN ESSO CONTENUTE, SE DERIVANTI DA ERRORI DI STAMPA O TRASCRIZIONE.

I PREZZI, ESPRESI IN EURO SI INTENDONO AL PUBBLICO ESCLUSA IVA.

LE MISURE SONO ESPRESSE IN CM.

I DISEGNI DELLE SCHEDE TECNICHE E DEL LISTINO VENDITA E LE FOTO DELLE COMPOSIZIONI SONO INDICATIVE E NON RAPPRESENTANO L'EFFETTIVA ESTETICA DEL PRODOTTO. LA BIANCHINI S.R.L. SI RISERVA DI MODIFICARE, PER NECESSITÀ TECNICHE O MIGLIORAMENTI, I PRODOTTI SENZA PREAVVISO. NON SARÀ ACCETTATA ALCUNA CONTESTAZIONE PER L'INTERPRETAZIONE DI DISEGNI O PER LE MODIFICHE APPORTATE AD OGNI SINGOLO ELEMENTO.

OGGETTO: L'OGGETTO DELLA FORNITURA E IL PREZZO DELLA STESSA VENGONO ESPRESSAMENTE INDICATI DALLA PRESENTE SCRITTURA. TUTTO QUANTO NON SPECIFICAMENTE INDICATO S'INTENDE ESCLUSO. LA MODIFICA ANCHE DI UNA SOLA VOCE, SALVO PATTO CONTRARIO, FA DECADERE DA OGNI IMPEGNATIVA DI PREZZO ED OGNI VARIAZIONE O AGGIUNTA RISPETTO A QUANTO NOMINATO, SARÀ IN OGNI CASO A CARICO DEL CLIENTE.

ORDINI: GLI ORDINI SONO ACCETTATI SALVO APPROVAZIONE DELL'AZIENDA. LA BIANCHINI S.R.L. AD ORDINE ACCETTATO INVIERÀ UNA CONFERMA D'ORDINE AL CLIENTE. TRASCORSI 5 GIORNI DAL RICEVIMENTO DI QUEST'ULTIMA, L'ORDINE SI RITERRÀ VALIDO IN TUTTE LE SUE PARTI, PERTANTO NON SARANNO PIÙ ACCETTATI ANNULLAMENTI O MODIFICHE.

CONSEGNA: I TERMINI DI CONSEGNA ASSUMONO PER L'AZIENDA VALORE PURAMENTE INDICATIVO E NON VINCOLANTE.

PRODOTTO: I DATI TECNICI RELATIVI AI PRODOTTI RIPORTATI NEL PRESENTE LISTINO SONO PURAMENTE INDICATIVI. LA BIANCHINI S.R.L. SI RISERVA LA FACOLTÀ DI APPORTARE TUTTE LE MODIFICHE CHE RITERRÀ OPPORTUNE E NECESSARIE.

BOX CAMPIONARI: NON DEVE INTENDERSI IN SENSO TASSATIVO, IN QUANTO SUSSISTONO MARGINI DI TOLLERANZA DOVUTI A VARIAZIONI DEL PRODOTTO (COLORI, MATERIALI, MISURE, ECC.) OPPURE PRINCIPALMENTE DA FATTORI AMBIENTALI (UMIDITÀ, LUCE, ECC.).

CARATTERISTICHE DEL PRODOTTO: IL PRINCIPALE COMPONENTE UTILIZZATO NELLA COSTRUZIONE DEGLI ARREDI È IL LEGNO. IL LEGNO ESSENDO UN PRODOTTO NATURALE PUÒ CONTENERE DELLE DIFFORMITÀ DI VENATURA E DI TONALITÀ CHE SONO GARANZIA PROPRIA DEL MATERIALE STESSO E QUINDI NON DEVONO ESSERE INTESI COME DIFETTOSITÀ.

LA BIANCHINI S.R.L. NON GARANTISCE L' UNIFORMITÀ DELLA VENATURA DEL LEGNO E/O DEL COLORE PER MOBILI DI COLLEZIONI DIFFERENTI CHE VENGONO ABBINATI E NON SI ASSUME LA RESPONSABILITÀ DELLE DIFFERENZE CROMATICHE POSSIBILI IN CASO DI ORDINI PER COMPLETAMENTO O SOSTITUZIONE.

CONSISTENZA DELLE PARETI MURARIE: LA TENUTA DEI DISPOSITIVI DI FISSAGGIO È SUBORDINATA ALLA CONSISTENZA DELLE PARETI MURARIE/SOFFITTI/PAVIMENTI A CUI GLI STESSI SONO APPLICATI.

INSTALLAZIONE: È IMPORTANTE CHE VENGA ESEGUITA DA PERSONE REALMENTE COMPETENTI; SI DECLINA OGNI RESPONSABILITÀ PER ERRATI MONTAGGI DA PARTE DEL RIVENDITORE O DI TERZI E PER GLI EVENTUALI DANNI CONSEGUENTI.

NESSUN DANNO DIRETTO O INDIRETTO PUÒ ESSERE RICHIESTO PER MANCATA O RITARDATA CONSEGNA.

TRASPORTO: LA MERCE SE VENDUTA FRANCO FABBRICA VIAGGIA A RISCHIO E PERICOLO DEL CLIENTE MENTRE, SE VENDUTA FRANCO DESTINO, VIAGGIA A RISCHIO E PERICOLO DELL'AZIENDA FIN DOVE ARRIVANO GLI AUTOMEZZI SU SPONDA CAMION. VERRANNO ADDEBITATI GLI EVENTUALI COSTI DI FACCHINAGGIO PER IL POSIZIONAMENTO DELLA MERCE NEL MAGAZZINO DEL CLIENTE.

RECLAMI: I RECLAMI SONO AMMESSI SOLO SE FATTI ENTRO OTTO GIORNI DALLA DATA DI CONSEGNA. TRASCORSO TALE PERIODO L'AZIENDA DECLINA OGNI RESPONSABILITÀ. PER EVENTUALI DANNI CAUSATI ALLA MERCE DURANTE IL TRASPORTO, O COLLI MANCANTI, I RECLAMI DOVRANNO ESSERE MANIFESTATI AL VETTORE AL RICEVIMENTO DELLA MERCE. IL DOCUMENTO DI TRASPORTO FIRMATO AL MOMENTO DELLO SCARICO VALE COME DICHIARAZIONE DI ESATTA CORRISPONDENZA DI QUANTO IN ESSO CONTENUTO.

PAGAMENTI: PER NESSUN MOTIVO ED A NESSUN TITOLO IL CLIENTE PUÒ DIFFERIRE O SOSPENDERE I PAGAMENTI OLTRE LE SCADENZE PATTUITE IN FATTURA; IL MANCATO O RITARDATO PAGAMENTO ANCHE DI UNA SOLA RATA COMPORTERÀ LA DECADENZA DAL BENEFICIO DI TUTTI I TERMINI PATTUITI, RENDENDO IMMEDIATAMENTE ESIGIBILE L'INTERO CREDITO CON L'ADDEBITO DEGLI INTERESSI DI MORA PREVISTI PER LEGGE. IN QUALSIASI FORMA SIA CONVENUTO IL PAGAMENTO, SONO A CARICO DEL CLIENTE TUTTE LE SPESE PER GLI ONERI RELATIVI, COSÌ COME I RISCHI PER FURTI E/O SMARRIMENTI DEI TITOLI DURANTE LA CIRCOLAZIONE POSTALE E/O BANCARIA. GLI EFFETTI SONO DA NOI ACCETTATI SALVO BUON FINE E NON COSTITUISCONO NOVAZIONE DI CREDITO.

RESI: NON SI ACCETTANO RESI DI MERCE SE NON AUTORIZZATI DALL'AZIENDA. I RESI ACCETTATI DALL'AZIENDA DEVONO ESSERE INTEGRI, IMBALLATI E ACCOMPAGNATI DA REGOLARE DOCUMENTO DI TRASPORTO. IL TRASPORTO È A CARICO DEL CLIENTE. I PRODOTTI RESI VENGONO ACCREDITATI ALLO STESSO PREZZO PAGATO IN FATTURA AL MOMENTO DELL'ACQUISTO, ADDEBITANDO LE EVENTUALI PARTI DANNEGGIATE O DIFETTATE. SI PRECISA CHE NON VERRANNO ACCETTATI RESI DI ELEMENTI REALIZZATI SU MISURA.

LEGGE APPLICABILE E FORO COMPETENTE: LE VENDITE SOTTOPOSTE ALLE PRESENTI CONDIZIONI GENERALI SONO REGOLATE DAL DIRITTO ITALIANO, E, OVE APPLICABILE, DALLA CONVENZIONE DI VIENNA DELL'11 APRILE 1980, SULLA VENDITA INTERNAZIONALE. OGNI CONTROVERSIA TRA LE PARTI IN RELAZIONE ALLE VENDITE SARÀ DI COMPETENZA DEL FORO DI VERONA (ITALIA).

## GENERAL CONDITIONS OF SALE

---

VALIDITY: THIS PRICE LIST REPLACES AND REPLACES ALL PREVIOUS ONES STARTING FROM 1 APRIL 2024.

BIANCHINI S.R.L. RESERVES THE RIGHT TO MAKE ANY NECESSARY CHANGE AT ANY TIME AND WITHOUT PRIOR NOTICE AND DOES NOT TAKE ANY RESPONSIBILITY FOR ANY INACCURACY WHEN CAUSED BY TYPING OR TRANSCRIPTION ERRORS

PRICES, EXPRESSED IN EUROS ARE INTENDED TO THE PUBLIC EXCLUDED VAT.

DIMENSIONS ARE IN CM.

THE DRAWINGS IN THE TECHNICAL SHEETS AND THE PRICE LIST AS WELL AS THE PHOTOS OF THE COMPOSITIONS ARE INDICATIVE AND DO NOT REPRESENT THE ACTUAL LOOK OF THE PRODUCT. BIANCHINI S.R.L. RESERVES THE RIGHT TO MODIFY THE PRODUCTS, FOR TECHNICAL REASONS OR FOR IMPROVEMENT, WITHOUT PRIOR NOTICE. NO CLAIM SHALL BE ACCEPTED ON THE INTERPRETATION OF DRAWINGS OR ON THE CHANGES MADE TO EACH SINGLE ITEM.

OBJECT: THE GOODS TO BE DELIVERED AND THEIR PRICE ARE EXPRESSLY MENTIONED IN THIS DOCUMENT. ANYTHING THAT IS NOT SPECIFIED SHALL BE UNDERSTOOD AS NOT INCLUDED.  
THE CHANGE OF EVEN ONE SINGLE ITEM, IF NOT AGREED OTHERWISE, SHALL MAKE VOID ANY PRICE AGREEMENT AND EACH SINGLE VARIATION OR ADDITION TO WHAT IS LISTED WILL BE IN ANY CASE CHARGED TO THE CUSTOMER.

ORDERS: ORDERS ARE ACCEPTED ONLY ON APPROVAL BY THE COMPANY. AFTER ACCEPTING THE ORDER, BIANCHINI S.R.L. WILL SEND A CONFIRMATION OF ORDER TO THE CUSTOMER. AFTER 5 DAYS FROM RECEPTION OF THE CONFIRMATION OF ORDER, THE ORDER WILL BE CONSIDERED VALID IN ALL ITS PARTS AND THEREFORE NON CANCELLATIONS OR CHANGES WILL BE ACCEPTED ANY LONGER.

DELIVERY: THE DELIVERY TERM IS MERELY INDICATIVE FOR THE COMPANY AND IS NOT BINDING.

PRODUCT: THE TECHNICAL DATA CONCERNING THE PRODUCTS AND PROVIDED IN THIS PRICE LIST ARE MERELY INDICATIVE.  
BIANCHINI S.R.L. RESERVES THE RIGHT TO MAKE ANY CHANGE IT WILL CONSIDER APPROPRIATE AND NECESSARY.

SAMPLES BOX: IT SHALL NOT BE UNDERSTOOD IN ABSOLUTE TERMS SINCE THERE ARE TOLERANCES LINKED TO SLIGHT DIFFERENCES IN THE PRODUCTS – COLOURS, MATERIALS, SIZE, ETC. – OR MAINLY DUE TO ENVIRONMENTAL FACTORS SUCH AS HUMIDITY, LIGHT, ETC.

PRODUCT CHARACTERISTICS: THE MAIN MATERIAL USED TO MAKE THE FURNITURE IS WOOD. WOOD IS A NATURAL PRODUCT AND THEREFORE CAN SHOW DIFFERENT GRAINS AND COLOUR SHADES THAT ARE A GUARANTEE OF THE MATERIAL AND MUST NOT BE CONSIDERED AS DEFECTS.

BIANCHINI S.R.L. DOES NOT GUARANTEE UNIFORM WOOD GRAIN AND/OR COLOUR FOR FURNITURE UNITS BELONGING TO DIFFERENT COLLECTIONS AND THAT ARE PUT IN THE SAME COMPOSITION. MOREOVER, IT DOES NOT TAKE ANY RESPONSIBILITY FOR DIFFERENCES IN COLOUR THAT CAN EMERGE IN CASE OF ORDERS MADE TO COMPLETE A COMPOSITION OR TO REPLAC AN ITEM.

COMPACTNESS OF WALLS: THE HOLD OF THE FASTENING DEVICES DEPENDS ON THE COMPACTNESS OF WALLS/CEILINGS/FLOORS TO WHICH THE DEVICES ARE APPLIED.

INSTALLATION: IT IS IMPORTANT THAT THE ASSEMBLY IS PERFORMED BY SKILLED PERSONNEL. NO LIABILITY IS TAKEN FOR WRONG ASSEMBLY BY THE DEALER OR THIRD PARTIES AND FOR ANY DAMAGE DERIVING FROM IT.

NO DIRECT OR INDIRECT DAMAGE CLAIM CAN BE RAISED FOR LATE OR NO DELIVERY.

TRASPORT: WHEN THE GOODS ARE DELIVERED EX WORKS, THE TRANSPORT RISKS ARE BORNE BY THE CUSTOMER. WHEN THE GOODS ARE DELIVERED FREE AT DESTINATION, THE TRANSPORT RISKS ARE BORNE BY THE COMPANY UP TO THE POINT WHERE THE TRUCK CAN REACH. ANY COSTS FOR UNLOADING AND POSITIONING THE GOODS IN THE CUSTOMER'S WAREHOUSE WILL BE CHARGED TO THE CUSTOMER.

COMPLAINTS: CLAIMS ARE POSSIBLE ONLY IF RAISED WITHIN EIGHT DAYS FROM THE DATE OF DELIVERY.  
AFTER THE EXPIRATION OF THIS TERM, THE COMPANY SHALL NOT TAKE ANY LIABILITY.  
IN CASE OF DAMAGE CAUSED TO THE GOODS DURING TRANSPORTATION OR FOR MISSING ITEMS, CLAIMS SHALL BE RAISED TO THE CARRIER WHEN RECEIVING THE GOODS. THE TRASNPOT DOCUMENT THAT SHALL BE SIGNED WHEN UNLOADING THE GOODS AND SHALL BE CONSIDERED AS A DECLARATION THAT THE GOODS EXACTLY CORRESPOND TO WHAT IS LISTED ON THE DOCUMENT.

PAYMENTS: FOR NO REASON THE CUSTOMER HAS THE RIGHT TO DELAY OR SUSPEND PAYMENTS BEYOND THE TERMS AGREED IN THE INVOICE.  
THE DELAYED PAYMENT OR NON-PAYMENT OF EVEN ONE SINGLE INSTALMENT SHALL CAUSE THE LOSS OF ELIGIBILITY TO THE CONDITIONS AGREED AND THE ENTIRE AMOUNT SHALL BE IMMEDIATELY PAYABLE WITH THE ADDITION OF THE LATE PAYMENT INTERESTS ENVISAGED BY THE LAW.  
IRRESPECTIVE OF THE TYPE OF PAYMENT AGREED, ALL COSTS AND RELATED BURDENS ARE BORNE BY THE CUSTOMER AS WELL AS THE RISK OF THEFT AND/OR LOSS OF THE TITLES WHEN IN THE POST AND/OR BANK CIRCUIT.  
BANKER'S DRAFTS ARE ACCEPTED SUBJECT TO COLLECTION AND ARE NOT CONSIDERED AS A RENEWAL OF CREDIT.

RETURNS: THE GOODS CANNOT BE RETURNED WITHOUT COMPANY AUTHORISATION.  
RETURNED GOODS AUTHORISED BY THE COMPANY SHALL BE UNDAMAGED, PACKED AND ACCOMPANIED BY THE TRANSPORT DOCUMENT ENVISAGED BY THE LAW.  
THE TRANSPORT SHALL BE CHARGED TO THE CUSTOMER.  
RETURNED GOODS ARE REIMBURSED AT THE SAME PRICE FEATURING IN THE SALE INVOICE.  
THE COSTS RELATED TO ANY DAMAGED OR DEFECT PARTS SHALL BE CHARGED TO THE CUSTOMER. MADE-TO-MEASURE ITEMS CANNOT BE RETURNED.

APPLICABLE LAW AND COMPETENT JURISDICTION: THE SALES REGULATED BY THESE GENERAL CONDITIONS ARE GOVERNED BY THE ITALIAN LAW AND, WHERE APPLICABLE, BY THE VIENNA CONVENTION OF 11 APRIL 1980 ON INTERNATIONAL SALES. ANY DISPUTE BETWEEN THE PARTIES CONCERNING THE SALES WILL BE UNDER THE JURISDICTION OF THE COURT OF VERONA (ITALY).







## MODESIGN

VIA G. AMENDOLA, 25 37052 CASALEONE (VR) ITALIA

PHONE +39.0442.333219 FAX +39.0442.330694

[www.modesignitalia.it](http://www.modesignitalia.it)

[info@modesignitalia.it](mailto:info@modesignitalia.it)

MARCHIO DI PROPRIETÀ: BIANCHINI S.R.L.



Materiali certificati e garantiti dal marchio VERO LEGNO.

All materials are certified and guaranteed by the VERO LEGNO (real wood) trademark.

FOLLOW US:



Le foto devono essere considerate come indicative e non costituiscono impegno per il produttore e/o Distributore. Per ragioni tecniche il produttore si riserva di modificare le caratteristiche dei prodotti senza preavviso.

The pictures are to be considered as illustrative only and are not binding for the Manufacturer and/or the Distributor. For technical reasons, the Manufacturer reserves the right to modify the characteristics of the products without previous notice.

**TESSUTI E PELLI**  
**FABRICS AND LEATHER**

**ECOPELLE | FAUX LEATHER** H. 140 | 69% PVC, 10% CO, 20% PES, 1% PU | Senza ftalati - phthalate free | PVC made in Italy, ignifugo classe (1IM) - Made in Italy PVC, fire resistant class (1IM) **CAT. A**



**ECONABUK MADE IN ITALY** H. 140 | 55% POL, 35% PU, 10% CO | Idrorepellente, facile da pulire - Water repellent, easy to clean **CAT. A**



**VELLUTO DELUXE | VELVET DELUXE** MADE IN ITALY H. 140 | 100% PL |  **CAT. B**

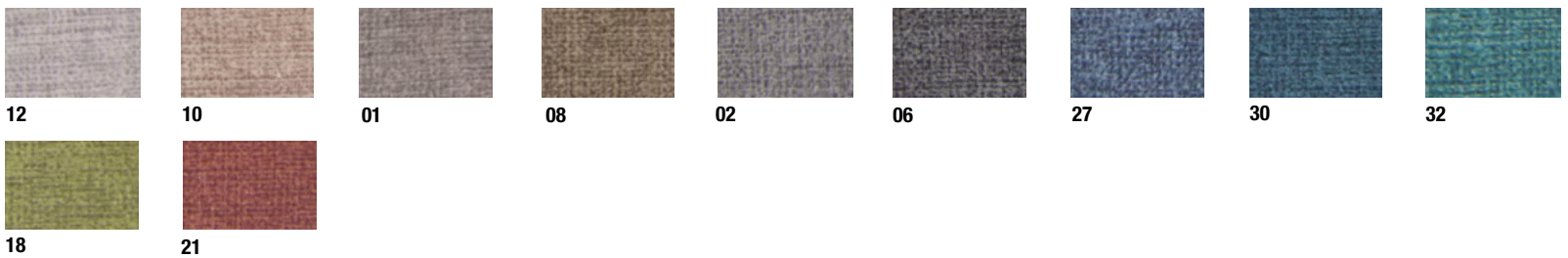

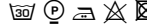
**LINO | LINEN** MADE IN ITALY H. 140 | 100% LI | Prelavato - Prewashed |  **CAT. B**

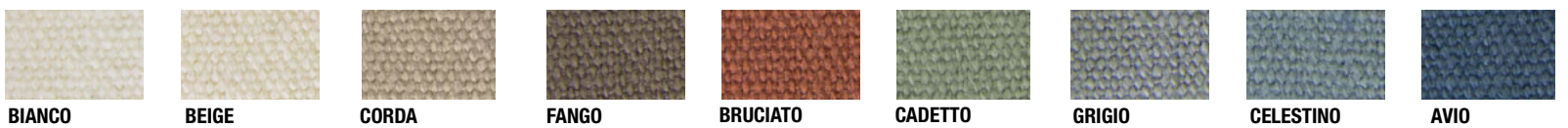

**PELLE | LEATHER** MADE IN ITALY **CAT. C**

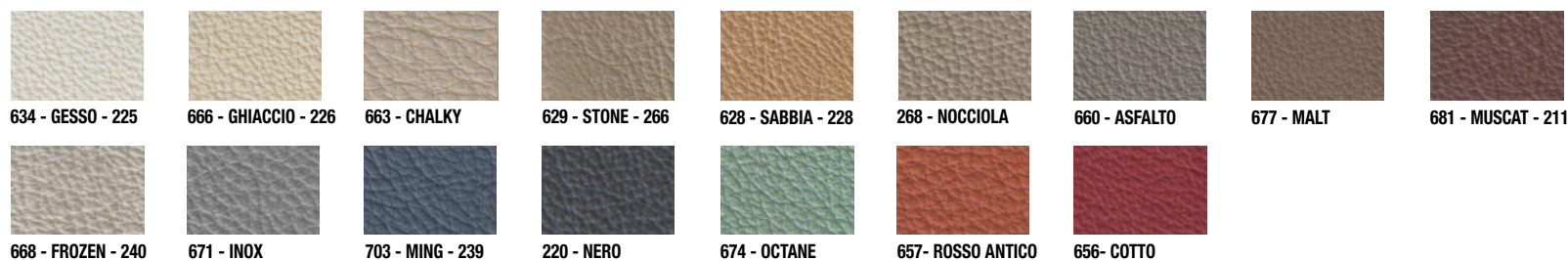

**BOUCLÉ** MADE IN ITALY H. 140 | 100% PES |  **CAT. B**



